



BERNSTEIN
TOOLS FOR ELECTRONICS



CATALOGUE
2020/2021



BERNSTEIN

TOOLS FOR ELECTRONICS

In the near future, many tool catalogues will only be available digitally. For this reason, the classic paper catalogue has a particularly high value.

Allow yourself be inspired by our designers' passion: They have once again put our enthusiasm for hand tools „on paper“, showcasing it in analogue form.

Sit back and flick through our catalogue to find numerous, exciting new products and discover the special features of our hand tools that solve the problems day-to-day work presents.

This edition focusses on our ESD tools, where the safety and reliability provided by a traditional manufacturer are of particular importance when producing such tools.

We have succeeded in developing the unique and versatile **SPANNFIX Maxi 4.0** in our range of clamping devices. The Spannfix Maxi 4.0 is the largest ball-joint vice on the market and will win you over with its clamping pins, interchangeable jaws, centering lug and fantastic ball clamping force.

In view of the fact that components are getting ever smaller, we have added an ultra-fine design to our successful range of tweezers. Featuring superfine tips, these high-tech tweezers are ideal for working under a microscope. We have developed a completely new range in response to the growing demands in quality assurance for controlled screwing: the Bernstein Torque Tools. The work areas have been designed to meet the specific needs of the electronics sector.

We are particularly proud of our new „Protection“ series of cases, featuring a futuristic look in a shell design with the Bernstein logo made of XABS plastic.

Take your time and discover other new products in our range of special tools for the electronics sector. Come and share our passion for hand tools with ultimate precision and quality!



BERNSTEIN
TOOLS FOR ELECTRONICS

QUALITY FROM EXPERIENCE

BERNSTEIN has specialised in the manufacture of ESD and precision tools since 1953. The BERNSTEIN company name first officially appeared in 1953 at the German exposition for radio and television in Düsseldorf. At that time, BERNSTEIN was the technology department of the company **Bernhard Steinrücke**, an iron-ware wholesaler in Lennep.

It wasn't until three years later that BERNSTEIN developed into an independent tool factory. During this periods, Bernstein manufactured a range of highly specialised hand tools for the

production, maintenance and repair of radios, television sets and other Hi-Fi equipment. The radio and television industry experienced a boom in the following years. BERNSTEIN products were represented and known in almost all the European fairs up until 1970.

Today, BERNSTEIN is one of the most famous manufacturers of hand tools for electronics and precision mechanics, and, together with its partners, supplies industry in Germany, Europe and the world.

BERNSTEIN draws on knowledge gained over many years to process Bernstein raw materials into high-quality tools with the highest standards in terms of quality and origin. Our product portfolio ranges from tweezers, pliers and screw drivers to custom, specialised tools to various clamping devices.

BERNSTEIN's area of specialisation is the manufacture of the Spannfix ball-joint vices and dissipative ESD tools.

BERNSTEIN

Werkzeugfabrik
STEINRÜCKE KG.

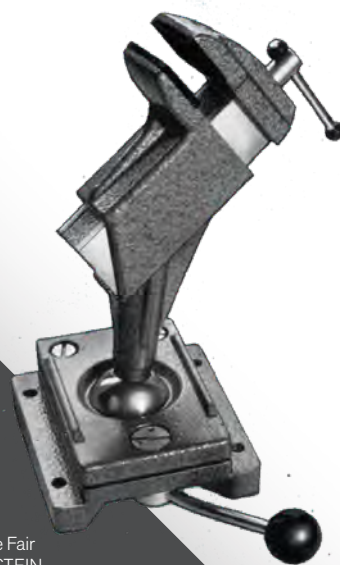

1956

Foundation
BERNSTEIN
Werkzeugfabrik
Steinrücke KG.

1959

With the handy pocket
„assistant“, BERNSTEIN
launches a portable
workshop for the first
time, which is unveiled to
the public at the Hanover
industrial fair in the same
year.

1961

The company is relocated
to its current location at
Industriehof Trecknase 1 in
Remscheid-Lennep.

1964

At the Munich Trade Fair
Electronica, BERNSTEIN
presents the multifunctional
vice „SPANNFIX“ and
„SPANNFIX VARIO“, which
remains a popular
product to this day.

2016

True to the motto „GO DIGITAL“, our new website went online in 2016, and since then has provided our customers with up-to-date information about our products.

2019

After one year in development, we are able to present the new generation of our large vice, the Spannfix 4.0.



FACTS AND FIGURES

GERMAN QUALITY

To guarantee high quality, 75 % of our products are made in Germany. Bought-in items are also inspected according to Bernstein's stringent quality criteria. Some of our products are pre-manufactured outside of Germany and further processed by BERNSTEIN.

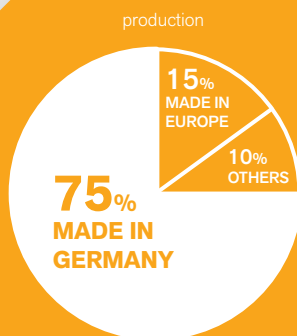

VERTRIEB



CUSTOMER



UNSERE KUNDEN SIND SO VIELSEITIG WIE UNSERE PRODUKTE!

We reach customers in Germany, Europe and across the world via our partners. We don't just supply the electronics industry. Our tools also find use in laboratories, test facilities, model making, the optical industry and dental sector.

2012

The company takeover in 2012 meant that it was time for a complete redesign of the corporate image. Since then, the orange diamond has stood for high quality.

2014

Our products have also been continuously adapted to the new course. In 2015, we created the BERNSTEIN case PROTECTION in an unmistakable design.





ESD – THE INVISIBLE DANGER

WHAT DOES EDS MEAN?

ESD stands for electrostatic discharge. It is caused by the sudden equalisation of charge between objects with a different charge potential. This discharge can generate a large amount of electrical current.

HOW IS ELECTROSTATIC CHARGE GENERATED?

Every object has positive and negative elementary particles. Positive and negative charges normally neutralise each other. Objects are electrically neutral. However, if an object loses electrons, an imbalance arises.

This imbalance is called the charge potential. Charged objects have a tendency to equalise by discharging. In the event of a sudden discharge, high currents flow in a small electronic component.

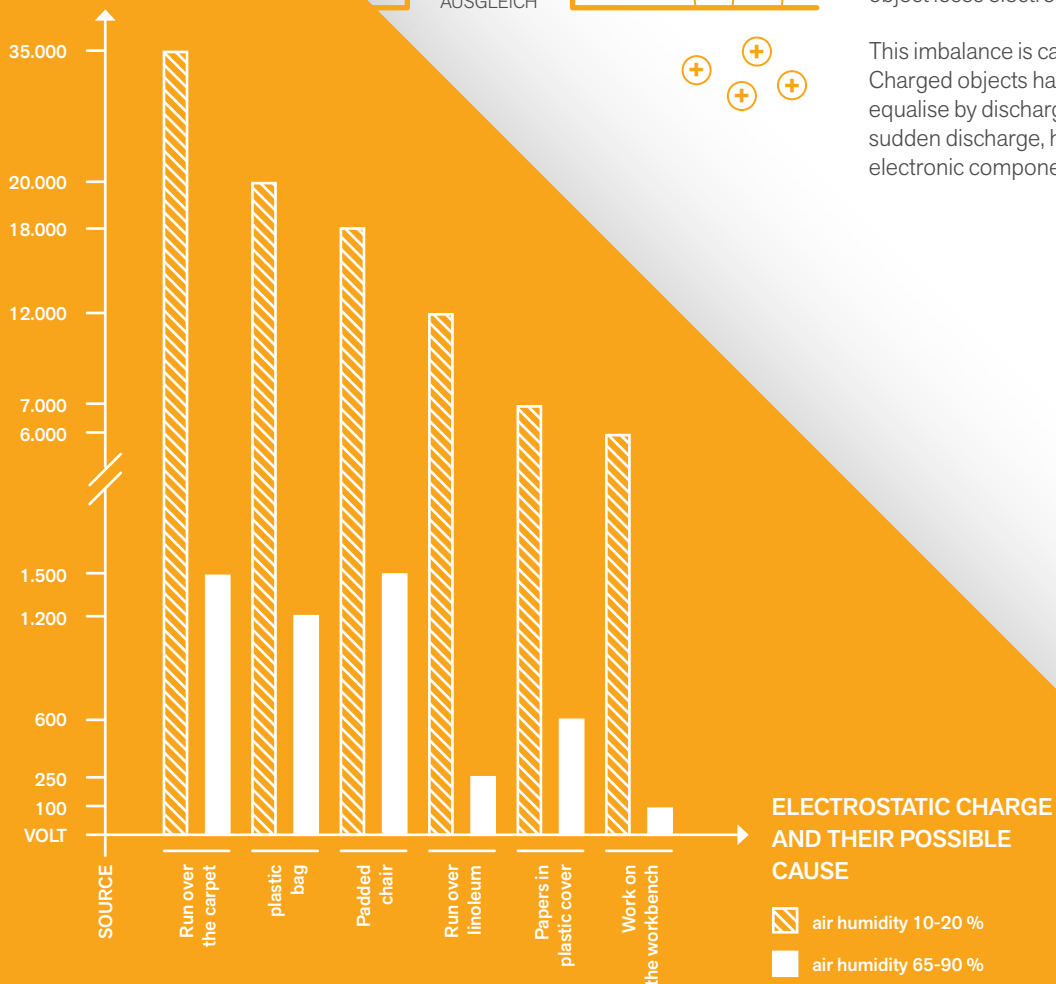

ELECTROSTATIC DISCHARGE IN EVERYDAY LIFE

The most visible form of electrostatic discharge is lightning during a storm, when clouds with different potentials abruptly discharge. All of us have at one point experienced a sudden discharge, such as after walking across a carpeted floor and then touching the handle of a door.



FOLLOWS ELECTROSTATIC UNLOADING OF COMPONENTS

Date of damage detection	value	efforts
component level	1x	part costs production stop
assembled circuit board	10x	part costs production stop error search repair costs
finished, tested product	100x	part costs production stop error search repair costs inspection costs delivery delays
delivered product	1000x	Replacement/repair costs Field service / delivery costs compensation loss of reputation

COMPONENT SENSITIVITY

The ESD sensitivity of electronic components is rising as component parts are increasingly miniaturised. Moreover, ever smaller components offer less and less space for protective circuits on microchips. In order to save energy, components need to get by on less power. A discharge of just 50 volts is enough to cause damage to a blue LED, for example. SMDs are already at risk of damage at voltages higher than 100 V. In contrast to this, the human ability to perceive ESD is very limited. Discharges are first noticeable from 3500 volts, audible from 4500 volts and visible from 10000 volts.

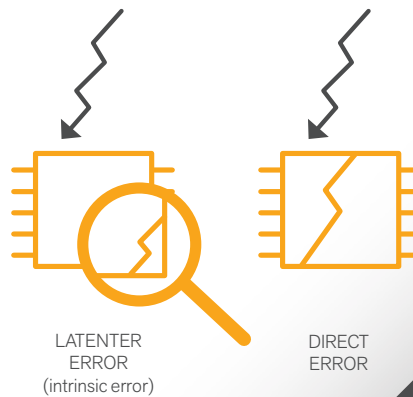

DETECTING AND ELIMINATING FAULTS

Components damaged by ESD cannot normally be seen with the naked eye. Even tiny discharges can lead to complete failure. These direct failures can usually be identified during quality control. So-called latent failures are especially critical, as they only become apparent when products are in operation. The time and effort needed to eliminate these intrinsic failures cause the greatest costs. ESD damage generally concerns latent damage. It is therefore absolutely essential that the appropriate precautions are taken.

FAILURE CAUSE ELECTRONICAL COMPONENTS

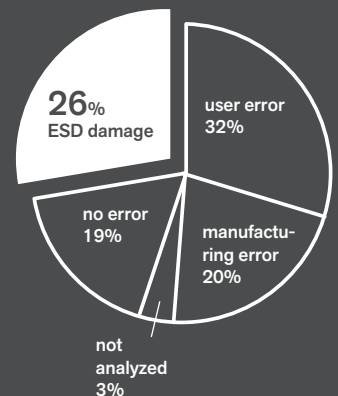



ESD – HOW TO PROTECT YOURSELF AND YOUR COMPONENTS

HOW CAN YOU PROTECT COMPONENTS?

You can protect ESD-sensitive components by storing, handling and packing them in a completely ESD protected environment. Precautionary measures are taken in these areas to eliminate electrostatic build-up. The difference in potential is neutralised by slowly dissipating the charge, thereby preventing a sudden discharge. This abrupt release constitutes the real danger. A very short and rapid discharge generates a very high discharge current.

MARKINGS AND SYMBOLS

It is important to identify ESD-sensitive components, ESD-safe working areas and ESD-safe objects. Safe objects are identified by a black triangle on a yellow background with a stylised hand surrounded by a circular arc. In addition, the acronym EPA (ESD protected area) is added for ESD protected areas. For ESD-sensitive components, there is no black circular arc and there is a line running through the hand to indicate ESD-sensitive products. It also makes sense to use ESD inspection tags which display the date when the object was last inspected for protective effectiveness.

WHAT DOES THE NORM SAY?

DIN - EN 61340-5-1/VDE 0300, Part 5-1 „Protection of electronic devices from electrostatic phenomena“ General requirements; DIN - EN 61340-5-2 / VDE 0300, Part 5-2 „Protection of electronic devices from electrostatic phenomena“, User guide; DIN - EN 61340-2-1 / VDE 0300, Part 2-1 „Measurement methods – Ability of materials and products to dissipate static electric charge“; DIN - EN 61340-4-1/VDE 0300, Part 4-1 „Standard test methods for specific applications – Electrical resistance of floor coverings and installed floors“; DIN - EN 61340-4-3/VDE 0300, Part 4-3 „Standard test methods for specific applications – Footwear“; DIN - EN 61340-4-5/VDE 0300, Part 4-5 „Standard test methods for specific applications – Methods for characterizing the electrostatic protection of footwear and flooring in combination with a person“.



ESD GROUNDING POINT

marked grounding point for all ESD components

SYMBOLS AND YOUR MEANING



ESD SAFED

marked ESD safe tools and objects



ESD DANGERED

marked endangered components and domains



ESD protected area

marked ESD protected area

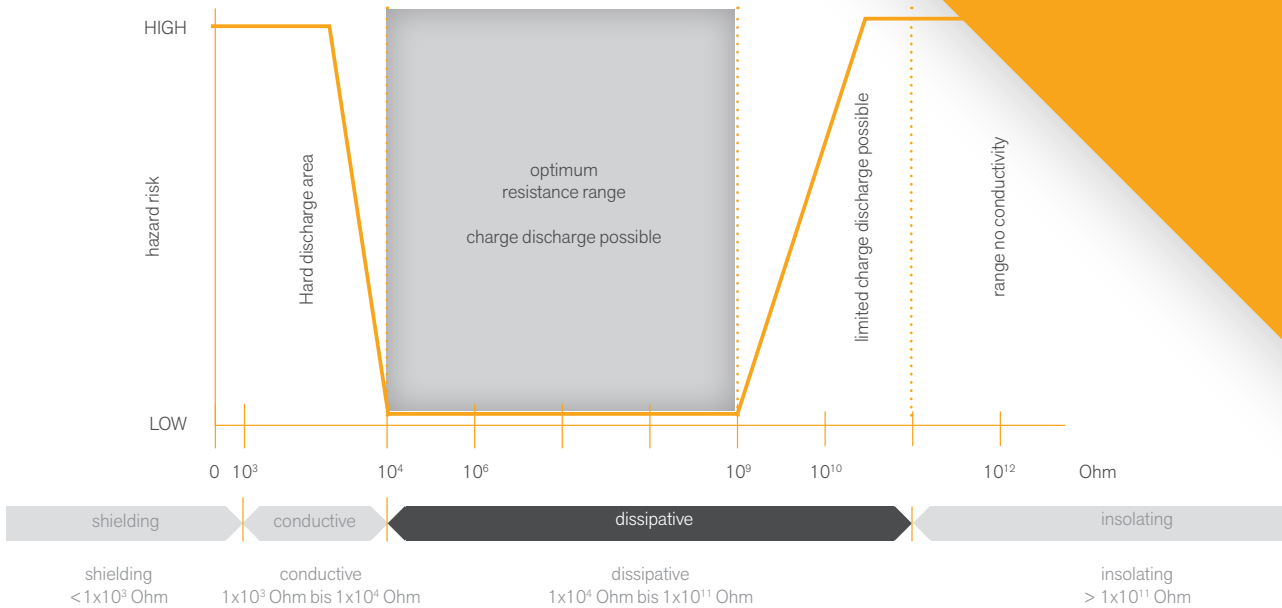

SURFACE RESISTANCES

The effectiveness of materials is classified according to their resistance properties. Here, surface resistance plays a particularly important role: it is the electrical resistance of a conductive layer on the surface. Depending on the resistance properties, a distinction is made between shielding materials, electrically conductive materials, electrically dissipative materials and insulating materials.

MEASUREMENT OF RESISTANCES IN THE ESD AREA

In addition to surface resistance, the following resistances are also important: the bleeder resistance (resistance against earth/protective conductor), volume resistance (resistance measured at opposite points of a material) and point-to-point resistance (resistance between two electrodes).

PERSONS AND WORKPLACES EQUIPMENT

If ESD-sensitive components are being handled, people and workplace equipment need to be ESD compliant. The primary focus for people is ESD-compliant clothing (shoes, coats, antistatic wrist straps), for workplace equipment, conductive flooring is just as important as ESD-compliant workbenches and chairs. The most important measure is the proper grounding of personnel.

ESD COMPLIANT TOOL

ESD-compliant tools are also just as important. In the Bernstein catalogue, you will find a comprehensive range of ESD-compliant tools for use in ESD protected areas. Often work needs to be performed outside of these protected areas, in which ESD-sensitive components need to be installed. We offer solutions here too, which are suitable for mobile use, such as table covers, grounding plugs for power sockets, clamping equipment and hand tools.

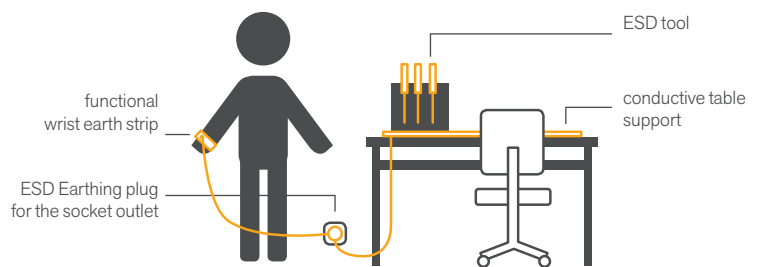

Simple design of an ESD-safe workstation for mobile use

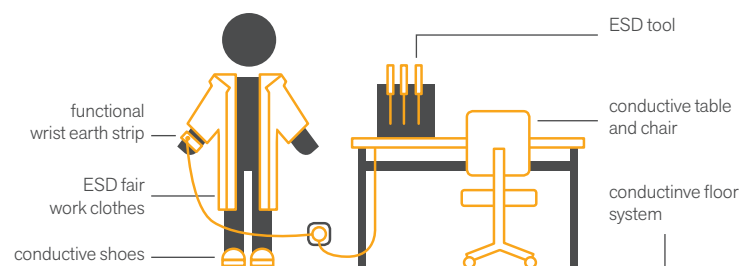

ESD-safe execution of a work schedule in the EPA area

OUR NEW PRODUCTS AT A GLANCE



CLAMPING TOOLS from page 15

▶ 9-290	SPANNFIX 4.0 - the next generation	16
9-291	SPANNFIX 4.0 base for clamping	17
9-284 SW	SPANNFIX base with magnetic feet	26
9-900-S6100	plastic protective jaws, felt 100 mm	21
9-900-S6125	plastic protective jaws, felt	21
9-900-S6150	plastic protective jaws, felt 150 mm	21
9-900-E50-ESD	ESD spare jaws plastic 50 mm	19

WORKPLACE EQUIPMENT from page 29



▶ 9-359-1	ESD earthing module	32
▶ 9-359-2	ESD earthing plug	32
9-344-1	ESD earthing cable 1.8 m	32
9-341-1	ESD contact bracelet gelb	33
9-341-2	ESD spiral cord gelb 2.4 m	33
9-341	ESD contact bracelet with spiral cord	33
9-354-100	ESD table mat 500 x 400 x 0.5 mm	34
9-360-0	ESD grounding mat 900 x 610 x 1.5 mm	34
9-361-0	ESD grounding mat 900 x 610 x 2 mm	34
9-367-0	ESD Erdungsmatte 610 x 450 x 2 mm	34
9-354-A	ESD handling set 900 x 610 x 1.5 mm	34
9-360-A	ESD handling set 900 x 610 x 2 mm	34
9-361-A	ESD handling set 610 x 450 x 2 mm	34
9-316-VE5	ESD chip container	36
9-161	ESD LED magnifying lamp WAVE	38

PLIERS from page 41

3-960 ES	ESD plier set EUROline pcs	48
3-962-15	ESD site cutter TECHNICline	50
3-972-15	ESD site cutte TECHNICline	50
3-986-15	ESD site cutte TECHNICline	50
3-993-15	ESD flat nose pliers TECHNICline	50
3-960 TS	ESD flat nose pliers set TECHNICline	51
▶ 3-734-13	ESD unscrew pliers	53

TWEEZERS from page 55

▶ Delicate tweezers, many new forms	58	
▶ tweezers with grip, for a better grip	63	
▶ ULTRA FINE tweezers	64	
▶ Geometric tweezers for different forms	66	
5-020	bamboo tweezer 150 mm	68
5-030-A	Titanium tweezer set 3 pcs	65
5-106-7	Tweezer stainless stell with guding pin	68
5-156-7	Soldering-cross tweezer 160 mm	71
5-857	SMD cross tweezer stainless steel	71
5-857-13	ESD SMD cross tweezer stainless steel	71
5-858	SMD cross tweezer stainless steel	71
5-858-13	ESD SMD cross tweezer stainless steel	71
5-879	Cutting tweezer (flush) 115 mm	71
5-879-13	ESD Cutting tweezer (flush) 115 mm	71



SCREW TOOLS from page 75

▶ Aluminium screwdriver	84	
4-932	Interchangeable blades TW0/FW0	76
5-090-1	Tool holder VARIO crafts	79
5-090-2	Tool holder VARIO inox	79
6-500	Wrench DIN 3110 Satz 8-tlg.	89
6-600	Combination wrench DIN 3113 set 12-tlg.	89





ADJUSTMENT TOOLS

from page 97

4-106	Screwdriver handle with 5/32"	101
4-107	Screwdriver handle with 1/4"	101
▶	Torque sets and adapter	97
▶	4-909 PEN Bit set 23 pcs	104
4-930	Bit set with torque screwdriver	103
▶	4-950 Screwdriver set 13 pcs	104
6-340-1	ESD Bit holder dissipative for 4 mm	101
6-340-3	Screwdriver bit set 42 pcs	105
▶	Bit adapter	101

INSPECTION, OPENING AND CLEANING TOOLS

from page 107

2-162	Glass fibre contact cleaner brush Ø 4mm	108
2-169-VE12	Replacement glass fibre for 2-168	108
2-164-VE24	Replacement brush 33 mm brass wire	108
2-155-13	ESD claw-type gripper	109
2-168	Glass fibre contact cleaner brush Ø 2mm	108

CUTTING AND MEASURING TOOLS

from page 111

2-102	Skalpellgriff mit 5 Klingen	113
5-301-13	ESD Schere mit Verzahnung	112
5-308-13	ESD Schere feine Verzahnung	112
5-310-13	ESD Schere abgerundet	113
5-517	Cuttermesser 160mm	113
7-516	Analoge Schieblehre 150mm	115

STRIPPING AND CRIMPING TOOLS

from page 121

5-532	Stripping and crimping tool 0,5 - 6 mm ²	123
5-533	Stripping tool for data lines	123
5-534	Data cable stripper Ø 4,5 - 10 mm	123
5-535	Coax cable stripper Ø 4,8 - 7,5 mm	123
5-536	Round cable stripper Ø 8 - 13 mm	123

VDE TOOLS

from page 127

▶	VDE multifunctional pliers	136
14-685 VDE	VDE combi screwdriver PH/S1	138
14-686 VDE	VDE combi screwdriver PH/S2	138
14-695 VDE	VDE combi screwdriver PZ/S1	138
14-696 VDE	VDE combi screwdriver PZ/S2	138
▶	VDE cable cutters	137
17-706 VDE	VDE rubber mat	140
8110	Tool case SAFETY 33 pcs	128
8300 VDE	Rucksack GLOBETROTTER 22 pcs	132

CASES AND SETS

from page 143

▶	2302 ESD tool set OPERATOR KIT	155
---	---------------------------------------	------------



GET IN CONTACT WITH US!

BERNSTEIN

Werkzeugfabrik Steinrücke GmbH

Industriehof Trecknase 1
42897 Remscheid

Tel. + 49 (0) 2191 - 9650 - 0
Fax + 49 (0) 2191 - 9650 - 30

sales@bernstein-werkzeuge.de







VISIT US ON THE WEB!

We update our product information on a regular basis and automatically using the Bernstein Product Information System. This enables the quick and up-to-date compilation of customer-specific data feeds for your own digital sale activities. Take advantage of this service and always keep Bernstein product information up to date!

www.bernstein-werkzeuge.de

Product videos and blog posts round off our online offering. Furthermore, we also respect the traditional sales channel via specialist retailers and offer the option to present your webshop as an online sales platform for products by BERNSTEIN.

SYMBOL LEGEND

	NEW products
	cross reference
	Made in Germany
	Number of tools in sets
	Weight
	Dimensions

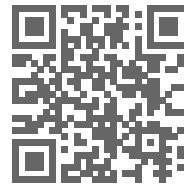

CONTENT



WISSENSWERTES

Editorial	01
BERNSTEIN – quality from experiences	02
ESD – The invisible danger	04
Contact - Get in contact with us!	08
New products	10
Content	11
Our assortment	12



CLAMPING TOOLS

SPANNFIX 4.0 – The Next Generation	16
SPANNFIX ball joint vice	20



ESD AND ELECTRONICS

Workplace equipment	29
Pliers	41
Tweezers	55
Screw tools	75



MAINTENANCE AND REPAIR

Adjustment tools and trimmer	91
Torque tools	97
Inspection, Opening and Cleaning tools	107
Cutting and Measuring tools	111
Hand tools	117



VDE AND ELECTRICS

Stripping and crimping tools	121
VDE tools	127



CASES AND SETS

Cases and sets (dissipative)	143
Cases and sets (non dissipative)	159



IMPORTANT

Register sorted by keywords	195
Register sorted by article numbers	197
Terms of sale and delivery	200



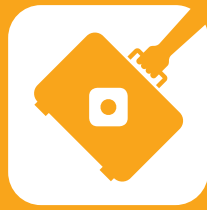

OUR ASSORTMENT IS VERSATILE

Every day, industry and trade put their trust in the reliability, safety and precision of hand tools manufactured by BERNSTEIN. Our range of special tools for electronics, electrical engineering and precision mechanics is characterised by high quality and assortment optimisation.

WE CANNOT ONLY OFFER STANDARD

The Bernstein product portfolio includes over 1000 standard products. Furthermore, we make every effort to fulfil individual customer requests. There are currently around 200 different items that are custom manufactured to our customers' specifications.

ESD tools

BERNSTEIN offers an almost complete assortment of high-quality ESD tools for working on electrostatically sensitive components. ESD pliers and ESD screwdrivers are equipped with grips that are electrostatically dissipative. ESD tweezers and ESD clamping equipment have a high-quality, dissipative powder coating which is burned in at 200 degrees Celsius.







CLAMPING TOOLS WITH BALL JOINT - OPTIMAL GRIP IN EVERY POSITION

Due to their complex geometry, workpieces, components or assemblies need to be able to be turned and held in different orientations during processing, servicing or repair.

BERNSTEIN offers various retaining tools to overcome such challenges. Our Spannfix product series ranges from classic screw heads to special attachments for the electronics industry to variable and versatile bases.

In all of our Spannfix products, we manufacture our high-grade, precise ball joint from steel, the ball joint can be moved in many different positions and fixed steplessly with a simple press of the lever.

The different heads and bases in our Spannfix product line make flexible working possible in any location or situation. Depending on the application, they can be combined with each other.

This is how, for example, many of our various bases are used to hold cameras, monitors or other components.

The possibilities are endless. Get in touch with us if you can't find what you're looking for in our product range. Together we will find a solution!

sales@bernstein-werkzeuge.de

9-290

NEW

SPANNFIX 4.0 THE NEXT GENERATION



OUR EVOLUTION OF THE SPANNFIX MAXI

Featuring a jaw width of 100 mm, the SPANNFIX 4.0 is the largest ball-joint vice on the market and will win you over with its clamp pins, interchangeable jaws, centering lug and fantastic ball clamping force.

The ball joint allows the head of the Spannfik to be turned 360° and tilted up to 90°. Work can be performed at every angle imaginable. Different shapes no longer present a problem. It doesn't matter if the workpiece is round or angular, the user can clamp anything.

The four tensioning studs suit the product in shape and size. They can be rotated about their axes and firmly grip any object. The centering lug allows for vertical work. The workpiece can be held level and worked on.

In addition to the clamping studs, the Spannfik features a profiled steel jaw that was designed as a reversible jaw and can be replaced. It has a smooth side as well as a side with a stepped edge and two vertical notches that prevent rods and bolts from sliding.

An integrated ruler offers the possibility to read the clamping depth directly on the vice. That way you can get the most out of the 105 mm clamping width.

The innovative base including table clamp enables the SPANNFIX to be mounted to straight table edges of up to 80 mm, and even to the table corner itself – the optimal position to use the Spannfik 4.0's entire working radius of 330 mm.

TECHNICAL FACTS:

Material:	Aluminium casting with chromed steel parts
Colour:	structured powder coating in dark grey metallic
Dimensions:	450 x 220 x 200 mm (dimensions for orientation)
Weight:	5500 g
Clamping pressure:	2940 N
Clamping width:	105 mm
Clamping depth:	50 mm
Jaw width:	100 mm
Table thickness:	up to max. 80 mm
Working radius:	330 mm (from ball centre)





Click here for the product film!

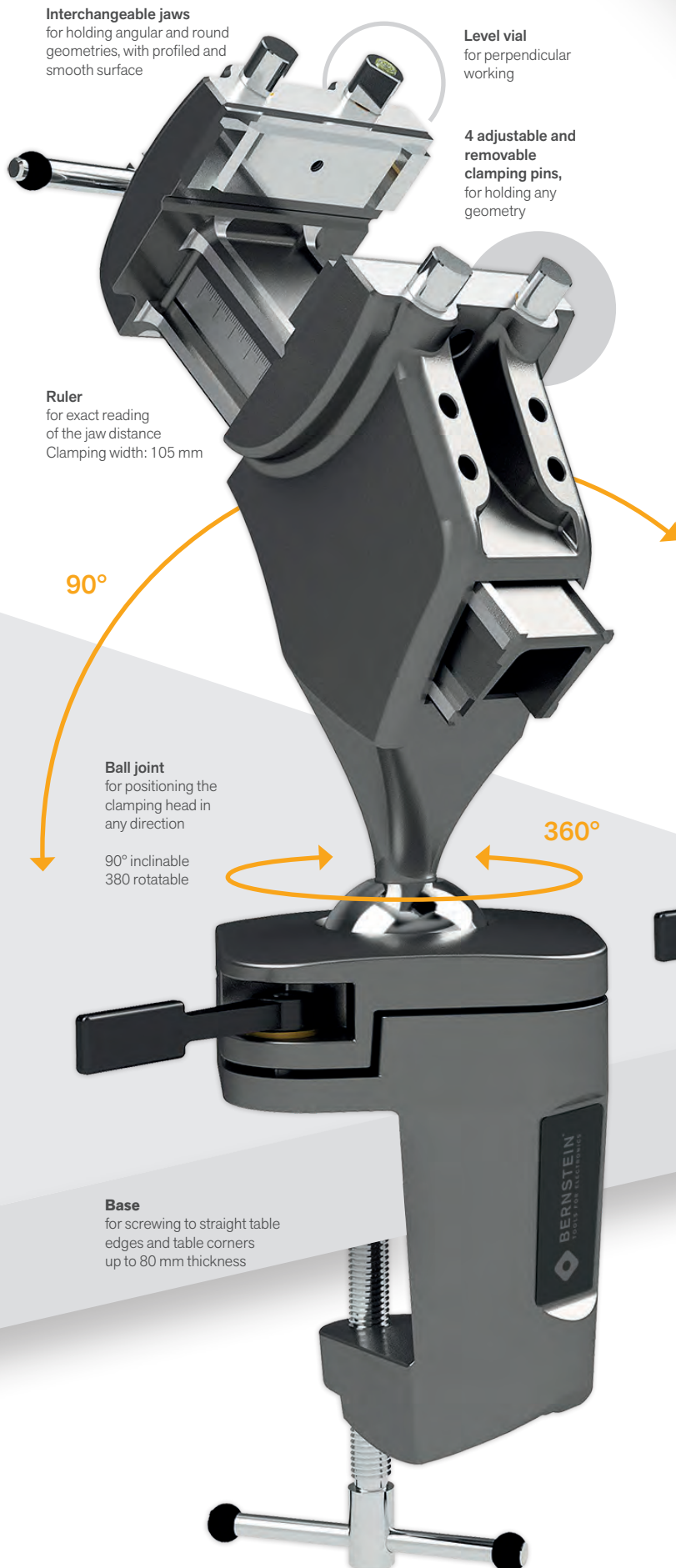

The following types are available:

- 9-290 Ball joint vice SPANNFIX 4.0 for clamping on
- 9-291 Ball joint vice SPANNFIX 4.0 base with clamping screws (M12x1.5)



Suitable for straight table edges and table corners

SPANNFIX – CLAMPING TOOLS WITH BALL JOINT

WHAT OUR CLAMPING TOOLS DISTINGUISHES

The SPANNFIX is a multifunctional vice with a flexible head and many possible applications.

By using the high-quality ball joint, the SPANNFIX head can be tilted and fixed in any direction and offers optimum hold in any position.

The ball mobility can be individually adjusted with the help of an adjusting screw on the lower seat of the ball.

The ball is fixed and released with a simple movement of the lever.

Long service life is guaranteed by the high-quality, powder-coated cast aluminium and surface-coated steel parts.

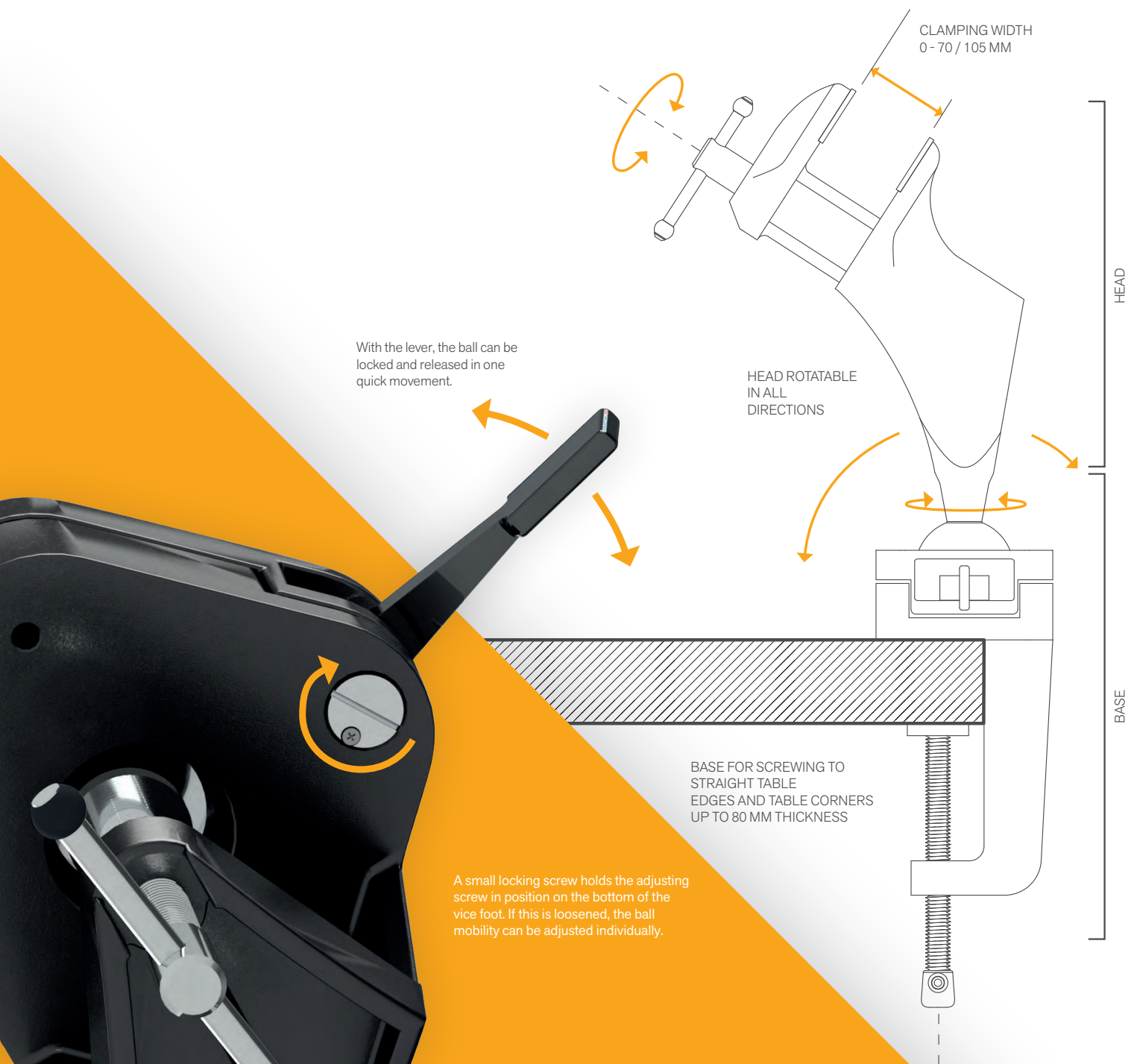

MODELS AND TYPES

The Spannfix is available in the models STANDARD, VARIO, MAXI and 4.0.

The STANDARD and VARIO models are also manufactured in different colours. The Spannfix VARIO offers the possibility to combine bases with different heads for various applications.

Bases by BERNSTEIN are frequently used for mounting customers' own constructions.

The item numbers shown in the table are described in the following pages.



NEW

Model	STANDARD		VARIO			SPANNFIX MAXI	SPANNFIX 4.0
Construction	solid		modular			solid	solid
Jaw width,/aterial	50 mm / plastic		50 mm / plastic			100 mm / steel	100 mm / steel
Features	Components are firmly connected to each other		Head and base can be individually combined with one another (except Art.-No. 9-262)			Large design, components are firmly connected to each other	Large design, components are firmly connected to each other
Colour variations	dark grey	ESD black	dark grey	ESD black	black	dark grey	dark grey
Surfaces	structured	smooth, silky gloss	structured	glatt, seidenglanz	fine structured, matt	structured	structured
Product variants Art.-No.	9-205	9-205 ESD	9-240			9-225	9-290
	9-215		9-250			9-226	
			9-270				
Bases Art.-No.			9-251	9-251 ESD	9-251 SW	9-227	9-291
			9-261		9-261 SW	9-228	
			9-262		9-262 SW	9-229	
			9-281		9-281 SW		
					9-284 SW		
Heads Art.-No.			9-252	9-252 ESD			
				9-253 ESD			
				9-255 ESD			
			9-254				
				9-257 ESD			
Spare jaws Art.-No.	9-900-0181 ESD (single) 9-900-E50-ESD (pair)		9-900-0181 ESD (single) 9-900-E50-ESD (pair)			9-900-0766-1	9-900-0773-1
Protective jaws	Available in different versions see following page						

With many new features!

Find out more on the following page!

SPANNFIX MAXI - PRODUCT VARIANTS

► 9-226

Ball joint vice SPANNFIX MAXI for CLAMPING ON



The SPANNFIX MAXI 9-226 is suitable for all workbenches and surfaces due to its screw-on base. With the help of the four through holes (Ø 10 mm), the vice can be attached to any table top. One press of the lever is all it takes to fix the clamped workpiece in any position.

Clamping pressure: 2940 N
 Clamping width: 100 mm
 Clamping depth: 50 mm
 Jaw width : 100 mm
 Jaws: Steel, smooth and corrugated, reversible and replaceable



Position as shown:
 approx. 380 x 230 x 150 mm
 (dimensions for orientation)



Weight: 3600 g



SPANNFIX MAXI - BASES

► 9-227

Ball joint base SPANNFIX MAXI for CLAMPING ON

Colour dark grey metallic, surface structured
 Threaded pin: M 12 x 1.5
 Threaded pin length: 12 mm
 Weight: 2220 g



9-227

► 9-228

Ball joint base SPANNFIX MAXI for SCREWING ON

Colour dark grey metallic, surface structured
 Base plate size: 190 x 155 mm (holes Ø 10 mm)
 Threaded pin: M 12 x 1.5
 Threaded pin length: 12 mm
 Weight: 1850 g



9-228

► 9-229

Ball joint base SPANNFIX MAXI for SCREWING ON

Colour dark grey metallic, surface structured
 Base plate size: 190 x 155 mm (holes Ø 10 mm)
 Threaded pin: M 12 x 1.5
 Threaded pin length: 25 mm
 Intake area: Ø 40 mm
 Weight: 1900 g



9-229

EQUIPMENT - PROTECTIVE JAWS

As an addition, we offer various types of protective jaws which can be fixed to the steel jaws by magnets.

Plastic protective jaws with felt

One-sided felt covering/grooves, mit magnetic stripes

100 mm	125 mm	150 mm
9-900-S6100	9-900-S6125	9-900-S6150

Plastic protective jaws, yellow

Smooth on one side/grooves, mit magnetic stripes

100 mm	125 mm	150 mm
9-900-S7100	9-900-S7125	9-900-S7150

Aluminium protective jaws with rubber

One-sided rubber covering/smooth, with 2 magnets

100 mm	125 mm	150 mm
9-900-S8100	9-900-S8125	9-900-S8150

Aluminium protective jaws

with tread grooves/smooth, mit 2 magnets

100 mm	125 mm	150 mm
9-900-S9100	9-900-S9125	9-900-S9150



SPANNFIX STANDARD – PRODUCT VARIANTS

► 9-205

Ball joint vice SPANNFIX for CLAMPING ON



The SPANNFIX 9-205 is suitable for workbenches or work areas with a maximum table top thickness of up to 80 mm. The small vice with a ball joint can be attached quickly and easily to any workbench or worktop due to its table clamp. A small pressure of the lever is sufficient and the clamped workpiece can be fixed steplessly and in any practical working position.

Clamping pressure:	1470 N
Clamping width:	70 mm
Clamping depth:	38 mm
Jaw width:	50 mm

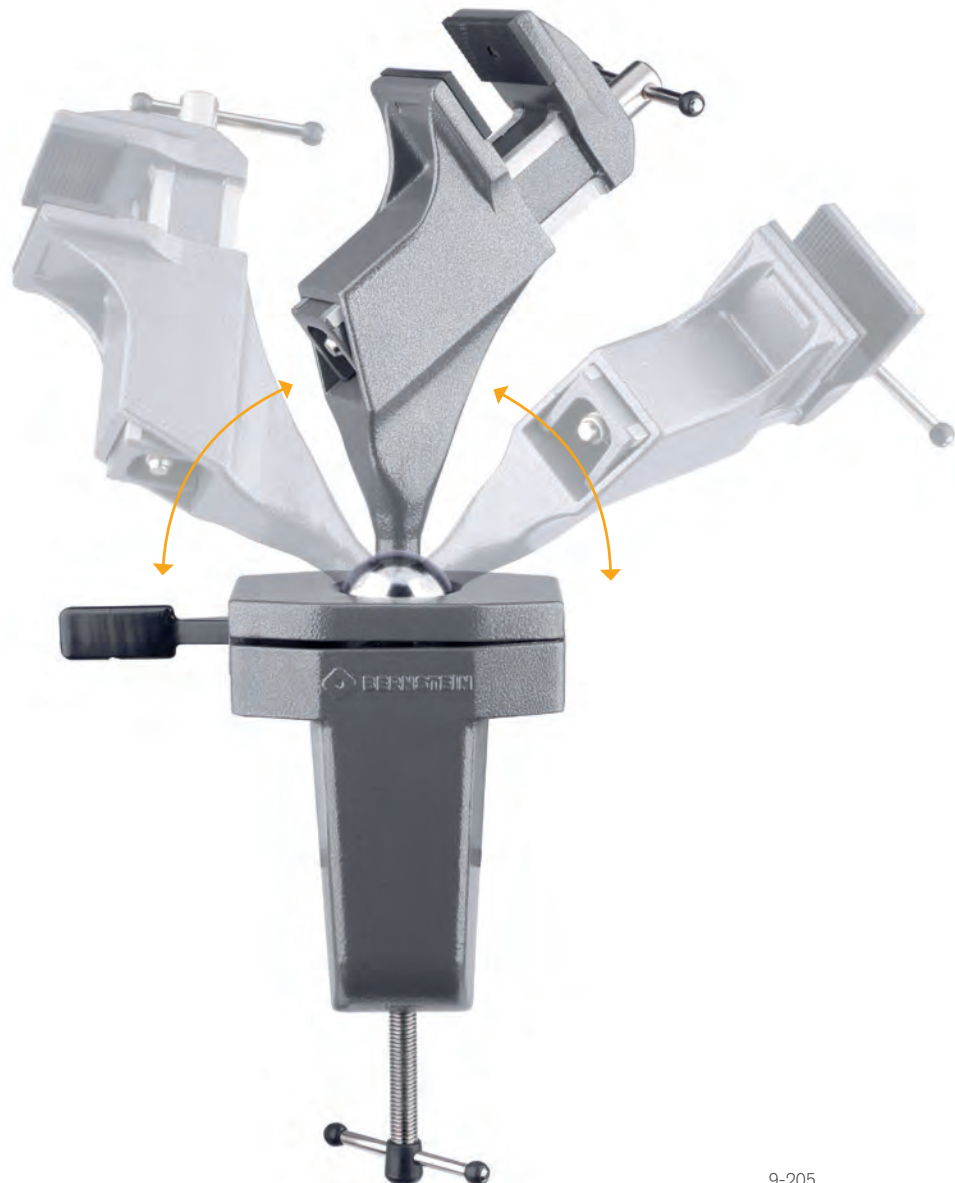

Position as shown:
ca. 310 x 160 x 75 mm
(dimensions for orientation)



Total weight: 1450 g

SPANNFIX STANDARD – PRODUCT VARIANTS

► 9-215

Ball joint vice SPANNFIX for SCREWING ON



The SPANNFIX 9-215 is suitable for all workbenches and surfaces due to its screw-on base. The vice can be attached to any table top using the four through holes (Ø 9 mm). A small pressure of the lever is sufficient and the clamped workpiece can be fixed steplessly and in any practical working position.

Clamping pressure: 1470 N
Clamping width: 70 mm
Clamping depth: 38 mm
Jaw width: 50 mm



Position as shown:
ca. 220 x 160 x 115 mm
(dimensions for orientation)



Total weight: 1310 g



9-215

► 9-205 ESD

ESD ball joint vice SPANNFIX for CLAMPING ON, dissipative



The SPANNFIX 9-205 ESD with dissipative powder coating is suitable for workbenches or work areas with a maximum table top thickness of up to 80 mm. The small vice with ball joint is quick and easy to attach to any workbench or table top due to its table clamp. A small pressure of the lever is sufficient and the clamped workpiece can be fixed steplessly and in any practical working position.

Clamping pressure: 1470 N
Clamping width: 70 mm
Clamping depth: 38 mm
Jaw width: 50 mm
Bleeder resistor: $10^6 - 10^9$ Ohm



with grounding point



Position as shown:
ca. 310 x 160 x 75 mm
(dimensions for orientation)



Total weight: 1450 g



9-205 ESD

SPANNFIX VARIO – PRODUCT VARIANTS

► 9-250

Ball joint combination SPANNFIX VARIO 5 pcs



9-251



9-252

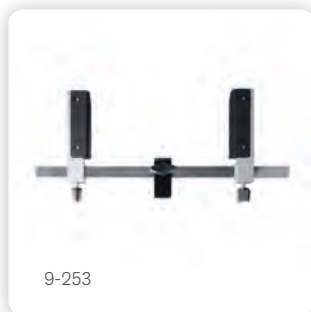

9-253

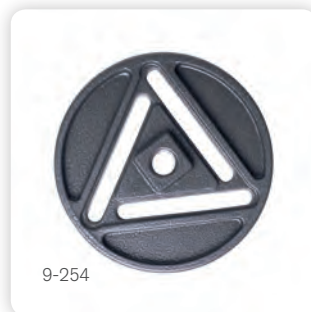

9-254

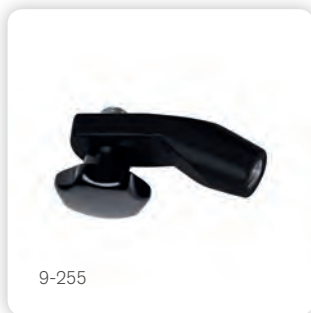

9-255

The three VARIO sets differ in the number of their replaceable SPANNFIX heads. The basic equipment includes the base with a table clamp as well as an adapter for holding the circuit board holder. The sets 9-250 and 9-240 include the simple angular adapter, while the 9-270 includes the practical quick turning device. The SPANNFIX 9-250 VARIO is additionally supplied with the SPANNFIX clamping head and a universal clamping plate. Due to their table clamping, all sets can be attached quickly and easily to any workbench or plate. A small pressure of the lever is all it takes to fix the head in any position.



► Description of the individual parts (for 9-250, 9-240, 9-270)

Art.-No.	Description
9-251	Ball joint base SPANNFIX for clamping on (threaded pin 12 mm)
9-252	Screw head SPANNFIX for screwing on (M12 x 1,5)
9-253	Circuit board holder for screwing on (M12 x 1,5)
9-254	Universal clamping plate SPANNFIX for screwing on (M12 x 1,5)
9-255	Angular adapter SPANNFIX for screwing on (M12 x 1,5)
9-256	Clamping lid SPANNFIX equipment for Art.-No. 9-253
9-257	Quick turning device SPANNFIX equipment for Art.-No. 9-253



Position as shown:
ca. 310 x 160 x 75 mm
(dimensions for orientation)



Total weight: 2100 g

SPANNFIX VARIO – PRODUCT VARIANTS

► 9-240

Ball joint combination SPANNFIX VARIO 3 pcs

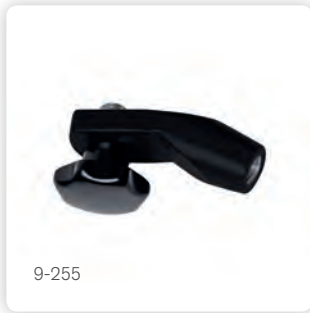

9-240



Position as shown:
ca. 360 x 280 x 180 mm
(dimensions for orientation)



Total weight: 1330 g

► 9-270

Ball joint combination SPANNFIX VARO-PLUS 4 pcs

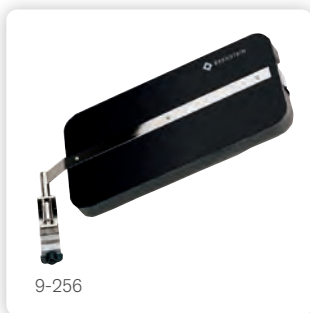
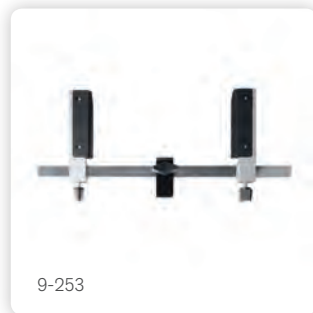

9-270



Position as shown:
ca. 410 x 300 x 240 mm
(dimensions for orientation)



Total weight: 1560 g

SPANNFIX – BASES

The variable SPANNFIX bases enable exact and safe positioning in all directions, e.g. of sensors, measuring devices, monitors and surveillance cameras. The ESD versions have a conductive black surface with a **bleeder resistor between 10⁷ and 10⁸ Ohm**.

▶ SPANNFIX base with ball joint and threaded pin M12 x 1.5 for CLAMPING ON

9-251	Colour: dark grey metallic, surface structured
9-251 ESD	Colour: ESD black, smooth surface, silky-gloss
9-251 SW	Colour: black, surface fine structured, matt
	Threading pin with self-locking nut: M 12 x 1.5
	Threading pin length: 12 mm
	Weight: 940 g



9-251

9-251 ESD

▶ SPANNFIX base with ball joint and threaded pin for SCREWING ON

9-261	Colour: dark grey metallic, surface structured
9-261 SW	Colour: black, surface fine structured, matt
	Base plate size: 150 x 105 mm
	Threading pin with self-locking nut: M 12 x 1.5
	Threading pin length: 12 mm
	Through holes: Ø 9 mm
	Weight: 800 g



9-261

9-261 SW

9-262	Colour: dark grey metallic, surface structured
9-262 SW	Colour: black, surface fine structured, matt
	Base plate size: 150 x 105 mm
	Threading pin with self-locking nut: M 12 x 1.5
	Threading pin length: extra long 25 mm
	Intake area: Ø 40 mm
	Through holes: Ø 9 mm
	Weight: 850 g



9-262

9-262 SW

9-281	Colour: dark grey metallic, surface structured
9-281 SW	Colour: black, surface fine structured, matt
	Base plate size: 110 x 72 mm
	Bore size: Ø 6 mm
	Threading pin with self-locking nut: M12 x 1,5
	Threading pin length: 12 mm
	Weight: 650 g



9-281

9-281 SW

▶ SPANNFIX base with ball joint and threaded pin with magnetic feet

NEW

9-284 SW	Colour: black, surface fine structured, matt
	Base plate size: 110 x 72 mm
	Magnet size: Ø 20 mm
	Threading pin with self-locking nut: M12 x 1.5
	Threading pin length: 12 mm
	Holding force with plastic caps (without caps): 15 kg (32 kg)
	Shearing force with plastic caps (without caps): 7 kg (15 kg)
	Weight: 750 g



9-284 SW

SPANNFIX – HEADS

Different SPANNFIX head parts can be combined and connected with the base parts via a M12 x 1.5 screw connection.

▶ SPANNFIX head for SCREWING ON

9-252	Colour: dark grey metallic, surface structured
9-252 ESD	Colour: ESD black, smoot surface, silky-gloss
	Clamping pressure: 1470 N
	Clamping width: 70 mm
	Clamping depth: 38 mm
	Jaw width: 50 mm
	Weight: 560 g



9-252

9-252 ESD



▶ 9-253 ESD

ESD circuit board holder for SCREWING ON (M12 x 1.5) dissipative

Plastic parts ESD, steel parts nickel-plated
Mounting: fixed clamping fit due to built-in spring
Clamping width: up to 270 mm
Height of support rods: 70 mm
Weight: 280 g



9-253 ESD



▶ 9-254

Universal clamping plate SPANNFIX for SCREW ON (M12 x 1.5)

Colour: dark grey metallic, surface structured
Slots worked out for common standard screws for the assembly of prototypes or for holding e.g. tuners, line transformers, etc.
Weight: 95 g



9-254

▶ 9-255 ESD

ESD angular adapter SPANNFIX for SCREWING ON (M12 x 1.5), dissipative

Colour: ESD black, smoot surface, silky-gloss
For extending the turning radius when using Art.-No. 9-253
Weight: 95 g



9-255 ESD



▶ 9-256

Clamping lid SPANNFIX equipment for 9-253 ESD, dissipative

Surface chrome-plated, plastic and ESD foam
Clamping lid size: 240 x 130 mm
Components of different sizes are pressed on by the conductive foam of 20 mm in such a way that soldering is even possible after turning the circuit board holder.
Weight: 260 g



▶ 9-257 ESD

ESD quick turning device SPANNFIX equipment for 9-253, dissipative

Colour: ESD black, smoot surface, silky-gloss
With fixed angular adapter, enables fast rotation of board holder with board and cover plate by 180°.
Weight: 270 g



9-256



9-257 ESD



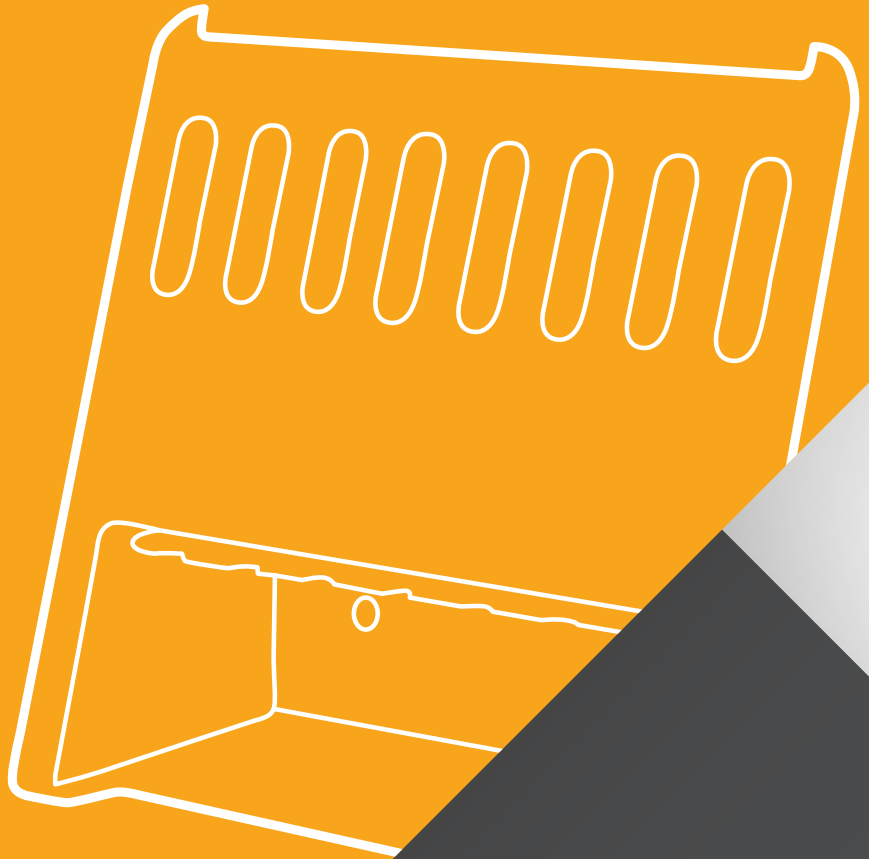
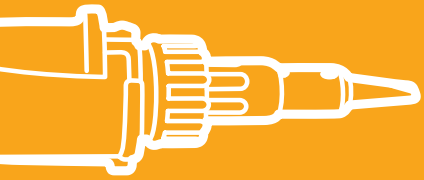
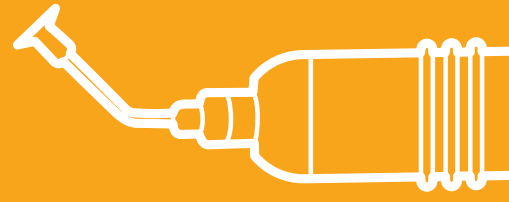
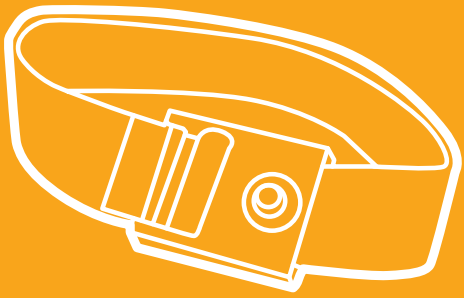
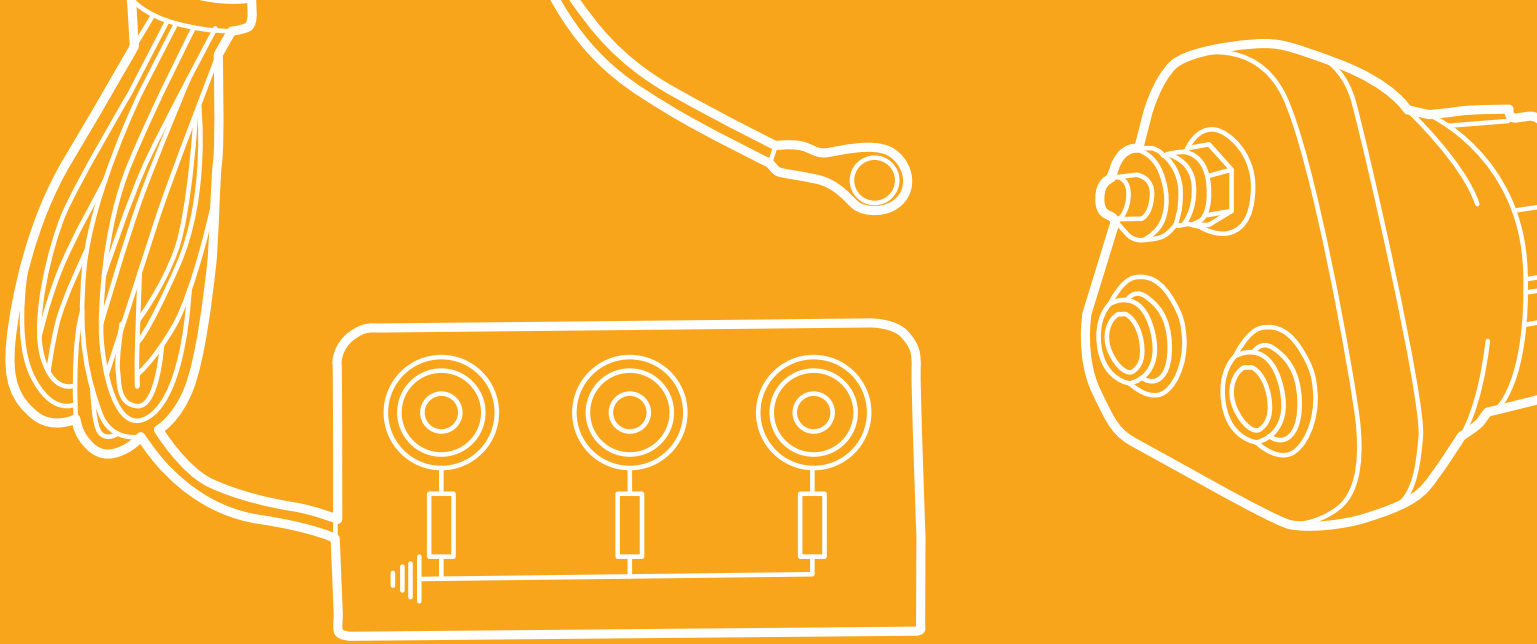

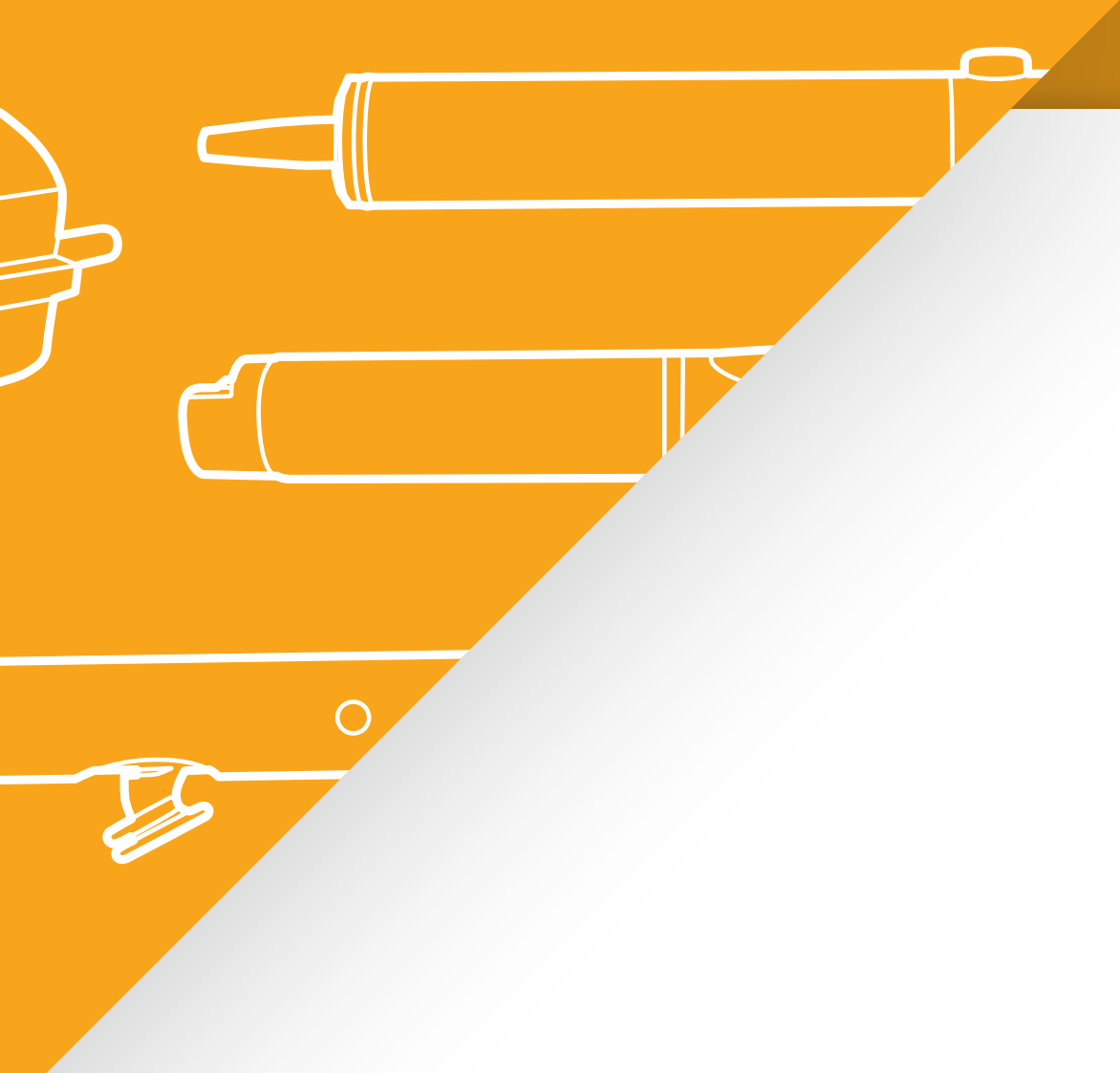

WORKPLACE EQUIPMENT – FOR GOOD AND SAFE WORKING

On the following pages we offer various products to equip a well-assorted and safe workplace.

For further information on the topic ESD and safety at the workplace, please also read the chapter „ESD - the Invisible danger“ in the front part of the catalogue. Here you will find an overview of leakage resistors, symbol explanations and other important information.



HOW YOU SET UP YOUR WORKPLACE IN A ESD-SECURE WAY

STATIONARY WORKPLACE - WORK IN THE EPA AREA

An ESD-safe workplace is indispensable in order to safely and properly carry out work and measurements on electrostatically sensitive components.

In fixed installations, such as in EPAs (electrostatic discharge protected areas), all elements that come into contact with people and components should be electrostatically conductive.

Foot mats, workplace pads, large assemblies and personnel grounding are earthed by so-called earth bonding plugs, while it is important to pay attention to ESD logos for clothing and tools.

MOBILE WORKPLACE - WORK ON THE ROAD

It doesn't happen often that fully assembled components or assemblies can be handled, repaired or serviced in ESD protected areas. This is where so-called ESD workplaces are needed.

The traditional mobile workplace (also called a handling set) consists of a workplace pad, a wrist band for grounding of personnel and an earthing cable with a earthing plug.

If there are no plug sockets available, the earthing cable can also be attached to grounded metal surfaces using a crocodile clip.

When properly set up, static electricity is discharged via the mat. But when using this method, it is important to make sure that the hand-to-earth resistance is less than 3.5×10^7 ohms.

MAINTENANCE AND CLEANING

Grounding connections, mats and earthing plugs should be inspected on a weekly basis and wrist bands every day.

Special cleaning agent must be used when cleaning them as conventional household products may leave behind an insulating coating.



CORRECT STRUCTURE OF THE COMPONENTS ON MOBILE WORKPLACE

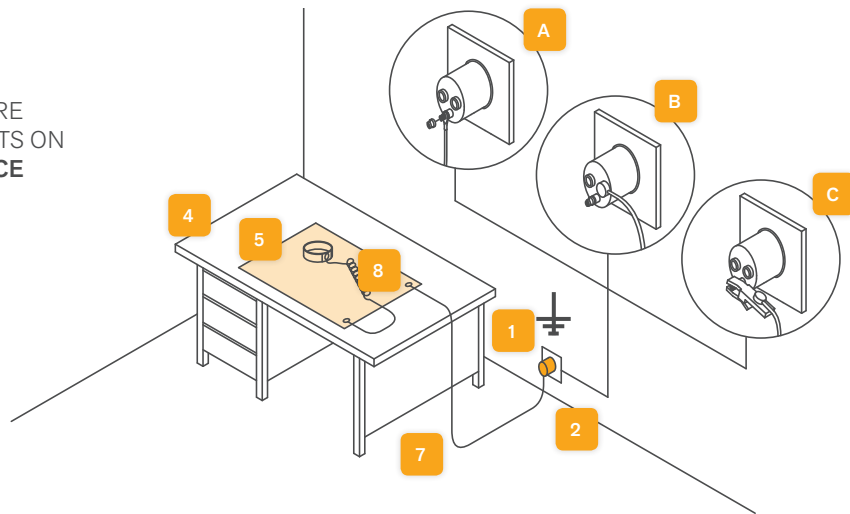

CORRECT STRUCTURE OF THE COMPONENTS ON STATIONARY WORKPLACE

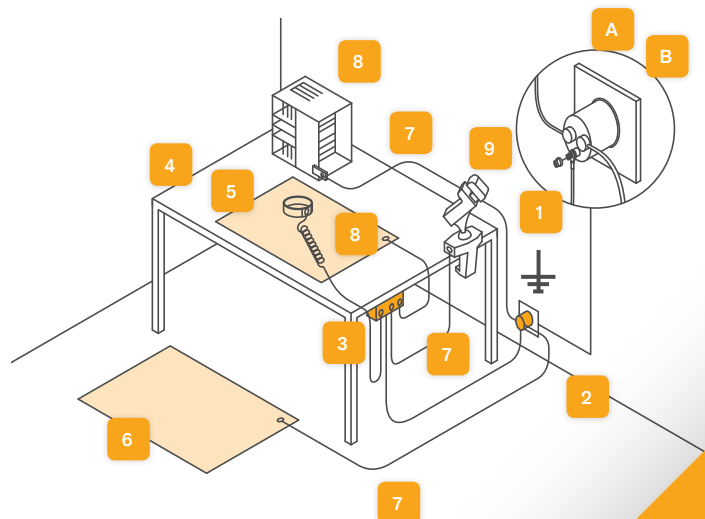

Explanations to the graphics:

COMPONENTS	SUITABLE ARTICLES FROM BERNSTEIN
1 grounding point	—
2 earthing plugs	9-359, 9-359-2 (für EU-Steckdosen)
3 earthing module	9-359-1
4 workplace	—
5 working mat	9-354, 9-360, 9-361, 9-367, 2291, 2301
6 floor mat	9-361, 9-367
7 earthing cables	9-343-1, 9-344-1, 9-359
8 personal grounding/bracelet	9-341, 9-342
9 Components and devices	z. B. 9-205 ESD (page 36)

Our workplace requirements can also be used as shelf supports

EARTH VARIANTS AT THE EARTH PLUG

- A by thread
- B by button
- C by clip

On the following pages you will find an overview and more detailed information on suitable products.



GROUNDING-, EARTH BONDING POINT

EPA suitable. For working in electrostatically protected areas (ESD workplace / ESD protection zone).



▶ 9-359-1

NEW

ESD earth bonding plug 3 x 10 mm with cable and eyelet

- EPB earth bonding point
 - for table screw connection, angled (incl. 2 screws)
 - as a ground connection point for personal grounding
 - cable length 2 m with 4 mm loop
 - 3 x 1 MOhm safety resistance, 10 mm press buttons
- Weight: 45 g



9-359-1

▶ 9-359-2

NEW

ESD earth bonding plug 2 x 1 MOhm and M5 connection

- EPB earth bonding point
 - Earthing plug with cable for EU sockets
 - as a ground connection point for personal grounding
 - ESD earth bonding plug 2 x 1 MOhm and M5 connection, 10 mm press buttons
 - 1 x screw connection M5 for 4 mm eyelet
 - suitable cable: 9-343-1, 9-344-1
- Weight: 33 g



9-359-2

▶ 9-359

ESD Erdungsstecker 1 x 10 mm und Blindstecker

- Earthing plug with cable for EU sockets
 - schuko socket
 - 1 Mohm safety resistance
 - press buttons 10 mm
 - spiral cable 2.4 m long
- Weight: 5 g



9-359

▶ 9-353

ESD crocodile clip 1 x 10 mm

- with banana plug socket, 10mm press button
 - press buttons 10 mm
- Weight: 18 g



9-353

▶ 9-343-1

ESD grounding cable 2 x 10 mm connection

- for connection between table and floor coverings and for connection to an earth potential.
 - with 1 megaohm safety resistance
 - 2 press buttons 10 mm for mats or floor connection
 - cable length 1.8 m
- Weight: 40 g



9-343-1

▶ 9-344-1

NEW

ESD grounding cable 1 x 10 mm with eyelet 4 mm

- for connection between table and floor coverings and for connection to an earth potential
 - with 1 megaohm safety resistance
 - 1 flat press button 10 mm for mats or floor connection
 - 1 eyelet for M5 thread at the socket ground
 - cable length 1.8 m
- Weight: 40 g



9-344-1

CONTACT BRACELET, CABLE AND SETS



Wrist grounding, as a safe method to derive electrostatic charge from people, consists of an adjustable wrist strap with woven silver-plated synthetic fibers (close skin contact necessary) and a spiral cable which connects the wristband with the earthing point via press buttons, electrically dissipative.

The coiled cable has a safety resistance of 1 MOhm on each connection side and is approved for workplaces with a rated voltage up to 250 VAC. To ensure adequate insulation, the bracelet may only be stored in a dry place.

▶ **9-341-1** **NEW** **9-342-1**

ESD contact bracelet

- EPA suitable. For working in electrostatically protected areas (ESD workplace / ESD protection zone)
- meets the safety requirements for wrist grounding standard
- fit for 3-4 mm press button
- adjustable, anti-allergic, washable
- belt length 220 mm

Weight: 9 g

Art.-No.	Colour
9-341-1	yellow
9-342-2	blue, LGA tested according to BG / 818



9-341-1



9-341-2

▶ **9-341-2** **NEW** **9-342-2**

ESD highly elastic spiral cord for bracelet 2.4 m

- EPA suitable. For working in electrostatically protected areas
- 2 x 1 megaohm safety resistance
- 3 mm press button for wrist strap
- 10 mm press button for ground connection
- length 2.4 m

Weight: 25 g



9-341-2



9-342-2

▶ **9-342 / 9-341** **NEW**

ESD contact bracelet with spiral cord and crocodile clip

- EPA suitable. For working in electrostatically protected areas (ESD workplace / ESD protection zone)
- bracelet adjustable, anti-allergic, washable
- belt length 220 mm
- press buttons 3-4 mm for wrist strap and 10 mm for ground contact connection
- highly elastic 2.4 m long spiral cable
- 2 x 1 megohm safety resistor
- insulated crocodile clip for grounding with clamp connection

Weight: 60 g



9-342

Art.-No. set	9-341	9-342	9-343
bracelet	9-341-1 (yellow)	9-342-1 (blue)	—
spiral cord	9-341-2	9-342-2	9-343-1
crocodile clip	—	9-353	9-353



9-341

ESD GROUNDING MATS AND HANDLING SETS



NEW

EPA suitable. For working in electrostatically protected areas (ESD workplace / ESD protection zone).

▶ 9-354-100

ESD table mat 500 x 400 x 0.5 mm with 2 press buttons

Dissipative 10⁸ Ohm, surface resistance according to DIN IEC 61340-4-1 with 2 x 10 mm press buttons, for connection to an earthing plug, ideal for service work and mobile use
Weight: 130 g



▶ 9-360-0

ESD table mat black 900 x 610 x 1.5 mm

technical data: Abrasion (load: 5N) 130 mm³, hardness 80 Shore A, impression test 0.1 mm, temperature range of application - up to + 60°C, ESD mat suitable for table, shelf or floor resistance 10⁶ to 10⁷ ohm (back side 10³ to 10⁴ ohm), top and back side black electrostatically synthetic rubber, with 2 press buttons 10 mm for ground connection, extremely wear-resistant, permanently elastic, halogen free
Weight: 1000 g



▶ 9-367-0

ESD table mat grey 610 x 450 x 2 mm

technical data: Abrasion (load: 5N) 130 mm³, hardness 78 Shore A, impression test 0.1 mm, light reflectance 19 % - 29 %, temperature range of application - up to + 60°C, resistance 10⁶ to 10⁷ ohm (back side 10³ to 10⁴ ohm), Platinum gray on top, black back of electrostatically dissipative synthetic rubber, with 2 press buttons 10 mm for ground connection, solder-resistant workplace support, heat resistant, abrasion resistant, scratch proof, extremely wear-resistant, permanently elastic, halogen free
Weight: 700 g



▶ 9-361-0

ESD table mat grey 900 x 610 x 2 mm

technical data: Abrasion (load: 5N) 130 mm³, hardness 78 Shore A, impression test 0.1 mm, light reflectance 19 % - 29 %, temperature range of application - up to + 60°C, resistance 10⁶ to 10⁷ ohm (back side 10³ to 10⁴ ohm), Platinum gray on top, black back of electrostatically dissipative synthetic rubber with 2 press buttons 10 mm for ground connection, solder-resistant workplace support, heat resistant, abrasion resistant, scratch proof, extremely wear-resistant, permanently elastic, halogen free
Weight: 1400 g



All our mats are also available in practical sets:

Art.-Nr. Set	NEW		NEW		NEW		9-367
	9-354	9-354-A	9-360	9-360-A	9-361	9-361-A	
grounding mat	9-354-100	9-354-100	9-360-0	9-360-0	9-361-0	9-361-0	9-367-0
bracelt with spiral cord	9-342 (blue)	9-341 (yellow)	9-342 (blue)	9-341 (yellow)	9-342 (blue)	9-341 (yellow)	—
grounding cable	9-343-1	9-341-1	9-343-1	9-344-1	9-343-1	9-344-1	—
crocodile clip	9-353	—	9-353	—	9-353	—	—
ggrounding plug / earth bonding point	—	9-359-2	—	9-359-2	—	9-359-1 9-359-2	9-359

ESD MOBILE WORKING MAPS

p. 152

tool sets



▶ 2301

ESD dissipative workplace pad with 20 tool loops

Dissipative workplace pad with 20 tool loops for various uses.

The foldable tool folder made from ESD material also serves as an electrically dissipative workplace pad and, when unfolded, is 680 x 660 x 35 mm. The bleeder resistance is approx. 10^9 ohms in accordance with DIN 53482. **The workplace pad is equipped with 3 press studs for connecting a contact wrist band and an earthing cable.** The tool folder can be closed with two additional press studs and used as a tool wallet. The large support surface (660 x 435 mm) offers enough space to handle sensitive electronic components safely. For transport, the bag can be quickly folded to a handy size.

locating surface: 660 x 435 mm

Weight: 525 g



2301

▶ 2291

ESD dissipative workplace pad with 22 tool loops

A foldable tool bag with integrated work surface for various ESD applications. Handy tool flap pocket made of dissipative synthetic leather. The bag has a total of 22 rubber loops for holding tools and other parts. Thanks to the new design, the tool area can be set up with a Velcro loop, which significantly improves access to the tools. **The bag has two press studs that can be connected to a wrist strap and an earthing cable (included), which allows each workstation to be converted to an ESD workstation.** The large support surface (480 x 340 mm) offers enough space to safely handle sensitive electronic components. For transport, the bag can be quickly folded to a handy size and closed with a rubber band.

locating surface: 480 x 340 mm

Weight: 480 g



2291
Code scannen
für Produktfilm

DESOLDERING SUCTION PUMPS

▶ 8-390

desoldering suction pump PRAKTIK Ø 20 mm

Handy device in all-metal housing with replaceable Teflon tip, high suction power due to 2-fold sealing of the piston, Total length: 200 mm, Weight: 71 g



8-390

▶ 8-238

SMD vacuum pipette Vampir

for simple, safe and precise handling of SMD components, complete with angled suction nozzle and 3 suction cups 4, 6 and 9 mm (conductive) Total length: 150 mm, Weight: 60 g



8-238

GAS SOLDERING IRON

▶ 8-376

gas soldering iron butane lighter gas

GAS soldering iron is perfect for all mobile applications. The soldering iron is ignited by a piezo-electronic system. The on/off switch is marked with 1-0, the ignition switch is marked with a lightning. Soldering, hot air or hot knife by the placement of different soldering tips possible. with soldering tip width 2 mm, power infinitely variable 15 - 75 W, operating time 45 minutes. Housing antistatic, tip temperature up to soldering: 580°C Total length: 150 mm, Weight: 60 g



8-376

ESD HELPINT TOOLS AND ORGANIZER



EPA suitable. For working in electrostatically protected areas (ESD workplace / ESD protection zone).

p. 72 VARIOsets

► 5-090-0

ESD tool holder VARIO tronics (without tools)

For more tidiness in the workplace!
 The practical VARIO tronics tool holder is made of sturdy 1.5 mm sheet steel and has a high-quality, dissipative black powder coating. In addition to pliers and tweezers, it can also store our handy screwdrivers or round objects with a maximum diameter of 9 mm. The recess in the lower area allows the blades or tips of the tools to be quickly identified and selected. The locking aid at the rear edge additionally helps to hold each tool in position. Small noses on the upper edge of the suspension rail prevent pliers or tweezers from slipping down. The tool holder can be placed on a surface as well as hung. Two holes on the rear side allow easy mounting to the wall.
 Weight: 400 g



5-090-0

► 7-421

ESD brush bristles Ø 6 mm

Total length 147 mm,
 Weight: 9 g



7-421

► 7-422

ESD brush bristles width 20 mm

Total length 150 mm,
 Weight: 26 g



7-422

ESD boxes for SMD components (PU10)

storage box for microprocessors, boards, chips, etc.
 conductive 10² to 10⁵ ohm, to stick together
 lid with spring mechanism, known as „mouse toilet“

Art.-No. set	9-321-VE10	9-322-VE10	9323-VE10
inner dimension	16 x 12 x 15 mm	37 x 12 x 15 mm	41 x 37 x 15 mm
Weight	5 g	10 g	15 g



9-321-VE10



9-322-VE10



9-323-VE10

► 9-316-VE5



ESD Chip-Container (VE5)

storage box for microprocessors, boards, chips, etc.
 conductive 10² to 10⁹ ohm, with conductive foam insert
 Inner dimension 57 x 36 x 17 mm, Weight: 15 g



9-316-VE5
 57 x 36 x 17 mm

► 9-334

ESD assembly grid mat

material natural rubber, electrically conductive 10³ bis 10⁴ Ohm
 tough mat as a stress-relieving tray, for SMD repairs
 printed circuit boards (PCBs) or devices,
 dimension 610 x 370 x 20 (cell size 50 x 45 mm), Weight: 3200 g

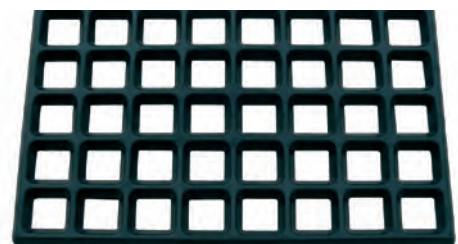

9-334

STEREO MICROSCOPES

Our microscopes are particularly suitable for the reliable inspection of material and assembly details as well as for the finest work in SMD technology.

► 9-155

stereo microscope with a stable

Stereo microscope with a stable metal tripod for incident light illumination. The field of view at a magnification of 10 x is 19 mm in diameter. The LED ring illumination has a bright, shadow-free incident light with a luminous colour of 5,800 K. The brightness can be steplessly adjusted between 0 and 15,000 lux.

CHARACTERISTICS

table stand	200 x 150 mm
magnification	10 x / 20 x expandable by attachable lenses up to 40 x
eyepieces wide field	10 x ocular tube left with diopter adjustment of + - 5 dpt, eyepiece cup
stereo head 45°	oblique view, 360° rotatable adjustable eye distance of 54 - 74 mm
Weight	5300 g



9-155

► 9-158

stereo microscope with stable hinge arm 850 mm length

Stereo microscope with stable metal tripod for incident light illumination. The field of view at a magnification of 10 x is 19 mm in diameter. The LED ring illumination has a bright, shadow-free incident light with a light colour of 5800 K. The light is illuminated by a LED ring. The brightness is continuously adjustable between 0 and 15000 lux.

CHARACTERISTICS

equipment	with stable table clamp and screw-on table base, Joint arm with 3 locking screws
magnification	10 x / 20 x expandable by attachable lenses up to 40 x
eyepieces wide field	10 x ocular tube left with diopter adjustment of + - 5 dpt, eyepiece cup
stereo head 45°	oblique view, 360° rotatable adjustable eye distance of 54 - 74 mm
Weight	5300 g

► 9-158-1

stereo microscope conversion lens 0,5

Lens with a factor of 0.5 increases the working distance from 83 mm to 100 mm.



9-158

INDUSTRIELLE LED-MAGNIFYING LAMPS

Optimum illumination according to the most modern, economical standard. The closed construction makes it a ideal instrument for mechanical, electronic, or other precision applications as well as for the printed circuit board, dental and jewellery industries.

Therefore, the highest value is placed on the light quality of the magnifier luminaires. They have powerful light sources with excellent luminous efficacy.

The quality and precise positioning of the light sources in relation to the lens allows almost shadow-free magnification and excellent colour rendering. The crown-glass-lens has a lower refractive index than magnifier luminaires with plastic lenses. It reduces the loss of light transmission through the lens, resulting in less image distortion.

The three-dimensional function is particularly useful for inspections and rework on printed circuit boards and similar delicate objects.

The loupes are specially designed to maximize horizontal and vertical movements. They are characterized by a considerable horizontal action radius and always maintain the correct position without drifting off. Exact positioning is possible thanks to the flexibility of the self-balancing arm and the joint between the lamp head and the arm.

WAVE and LFM with automatic switch-off function for more energy efficiency.

5 years warranty, delivery with dust cover and EU plug.

The following types are available:

CHARACTERISTICS	NEW			
	9-121	9-161	9-101	9-721
glass lens	3.5 dioptries (1,88x magnification)	5 dioptries (2,25x magnification)	3 dioptries (1,75x magnification)	2x 1.75 and 2.25 magnification
LED module	2 x 6W	2 x 6W	1 x 10W	ring with 9W
3 step dimmer	0-50-100%	0-50-100%	0-50-100%	—
focal length	297 mm, 4600 lux	297 mm, 4600 lux	330 mm, 1500 lux	6000 lux up to 15 cm ultra light led
colour temperature (CCT)	4000°K	4000°K	4000°K	6500°K
colour rendering index (CRI)	Ra 80	Ra 80	Ra 80	Ra 80
crown glass	rectangular 171 mm x 114 mm	rectangular 171 mm x 114 mm	round Ø 127 mm	—
power	13 W	13 W	11 W	7.2 W
voltage	230 V / 50 Hz	230 V / 50 Hz	230 V / 50 Hz	230 V / 50 Hz
shutoff	automatically after 4 or 9 hours	automatically after 4 or 9 hours	automatically after 4 or 9 hours	—
arm length	1050 mm	1050 mm	1000 mm	950 mm
colour	white	black	white	white
weight	4400 g	4600 g	2000 g	3000 g
expandable	Secondary attachment lenses (STAYS) with 4, 6 or 10 diopters can be attached to the crown glass lens. (STAYS: Self-Traction Accessory Yield System)			—

INDUSTRIELLE LED-MAGNIFYING LAMPS

► 9-121

LED magnifying lamp WAVE 3.5 dioptres

Flexible, self-balancing steel light arm, with aluminium head and table clamp (AH clamp). Efficient, dimmable, shadow-free 3D illumination, selectable LED left/right illumination. High-quality crown glass lens for maximum clarity, precision and visual comfort.

Industrial magnifier luminaires with powerful light sources and optimum illumination according to the latest economic standards. The quality and precise positioning of the light sources in relation to the lens enable almost shadow-free magnification. The crown glass lens has a lower refractive index than magnifier luminaires with plastic lenses, and reduces light transmission loss, resulting in less image distortion. Exact positioning is possible thanks to the flexibility of the self-balancing arm and the joint between the luminaire head and the arm. 5 year warranty, supplied with dust cover and EU plug.



9-121

► 9-161

ESD LED magnifier light WAVE 5 dioptres

Flexible, self-balancing steel light arm, with aluminium head and table clamp (AH clamp). Efficient, dimmable, shadow-free 3D illumination, selectable LED left/right illumination. High-quality crown glass lens for maximum clarity, precision and visual comfort.

Industrial magnifier luminaires with powerful light sources and optimum illumination according to the latest economic standards. The quality and precise positioning of the light sources in relation to the lens enable almost shadow-free magnification. The crown glass lens has a lower refractive index than magnifier luminaires with plastic lenses, and reduces light transmission loss, resulting in less image distortion. Exact positioning is possible thanks to the flexibility of the self-balancing arm and the joint between the luminaire head and the arm. 5 year warranty, supplied with dust cover and EU plug



9-161

► 9-101

LED magnifying lamp LFM 3.0 diopters

Round magnifying lamp in modern lightweight construction with small dimensions, as metal construction with LED (light emitting diode) light sources and a flexible spring arm. The glass lens with a diameter of 127 mm is located in the middle of an LED light ring. This enables perfect illumination of objects for shadow-free viewing.

Applications: Excellent for precision work, including electronic rework, deburring, sample preparation, preparation, assembly and manipulation, and wherever the smallest possible magnifying lamp is required.



9-101

► 9-721

LED magnifying lamp SLIM LINE 3.0 diopters

This elegant, slim magnifier is ideal for all your detail work, with very bright Daylight LEDs. With the adjustable inner spring arm you can easily position the lamp with one hand exactly where you need the light. In addition, the bright daylight LEDs offer high contrast and accurate colour matching, making it easier and less tiring to work.

Applications: Excellent for precision work, including electronic rework, deburring, sample preparation, preparation, assembly and manipulation, and wherever the smallest possible magnifying lamp is required.



9-721



PLIERS – THEY PERFORM WELL!

BERNSTEIN mainly offers electronics pliers for professional demands which are characterised by their consistent quality and a long service life. Our series of pliers differ from each other due to their different production methods and properties.

The EUROline, CLASSICline und BLACKline series of pliers are made from high-quality blanks which are hot forged in a die and inserted through the die. The pliers are oil hardened and the tips receive additional inductive hardening.

The TECHNICline series of pliers are cut by laser from ball bearing steel and further processed and refined in CNC machining centres, allowing us to achieve a particularly stable microstructure with enormous cutting performance.

This is why our pliers are suitable for cutting all types of wire. The tensile strength (soft, semi-hard, hard wire) is crucial for common resistance wire, solder wire, winding wire or heating wire (thermocouple wire). Particularly for copper wire, brass wire, steel wire, iron wire, aluminium wire, bond wire, tin wire, nickel wire, gold wire, silver wire, platinum wire, tungsten-copper wire, tungsten wire, glass fibre and even Kevlar.

Please note the cutting value given in the packaging of the pliers as well as the care instructions for a long service life.

PLIERS ARE NOT THE SAME AS PLIERS- WHAT IS THE DIFFERENCE?

MATERIALS

Depending on the model and the requirements, we use high-alloyed tool steels or high-grade ball bearing steel (chrome steel) from selected suppliers.

CONSTRUCTION

We manufacture pliers with four different joint constructions (joint) depending on the application and design of the pliers.

Lap joint

The simplest form for joining the two halves of a pair of pliers is the lap joint. Here, the levers are put on top of each other and connected by a hinge pin. This construction is only used for very crude pliers.

Single joint

For a single joint, the joint surfaces are also milled out so that the halves fit into one another and can be connected using a hinge pin.

Box joint

The most complex construction is the box joint. In a very special process, one lever is passed through the joint of the other lever which is opened using heat. The joint is then pressed together and connected with a pin. This construction ensures the best parallel motion of the tips and an extremely long service life.

Screw joint

The screw joint is manufactured with highly precise joint surfaces, ensuring smooth motion of the pliers and a uniform, low-friction open-close movement. In combination with the basic hardness of the high-quality chrome-vanadium ball bearing steel, the screw design provides a very high cutting performance with a long service life.



LAY-ON JOINT



LAP JOINT



BOX JOINT



SCREWED JOINT



SURFACES

Over the decades we have developed surface properties that meet the wide ranging applications and requirements arising in daily use.

This involves properties such as corrosion protection, hardness, abrasion, spalling, smoothness and surface roughness in order to ensure the optimal work results.

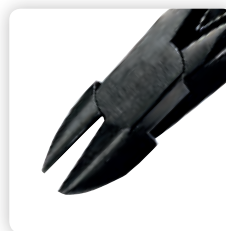

BURNISHED
(free of glare and reflections)



HIGH-GLOSS STEEL POLISHED



FINE POLISHED AND GLOSSY BURNISHED
(free of glare and reflections)

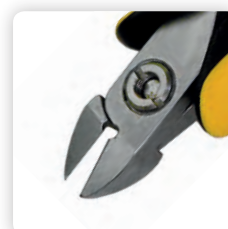

MATT FINISH
(free of glare and reflections)

p. 7 Bleeder resistance

CUTTING SHAPE AND CUTTING PERFORMANCE

The service life of the cutting tips depends on their sharpness. The sharper the edge (full flush) the quicker the wear. That's why semi-flush pliers are preferable as long as flush or shock-reducing cutting is not required.

Semi flush

This can be used for hard and soft steel wires and soft materials, such as copper wire. The cut leaves a pyramid-like tip at the end of the wire.

Flush

This provides an almost flush cut. It can be used for soft steel wires and copper wire. The cut is slightly shock reduced. It only leaves a very small tip at the end of the wire.

Full flush

This cuts completely flush and provides an extremely sharp cut. It is used exclusively for soft steel wires and copper wire and has a largely shock-reducing cut. It cuts absolutely plane-parallel.

Special flush

This is used to cut glass fibre, Kevlar, etc.

Fitted with carbide insert

Inserted with hard metal tips, designed for constant stress. These are also for tough nickel, electrode and tungsten wires.

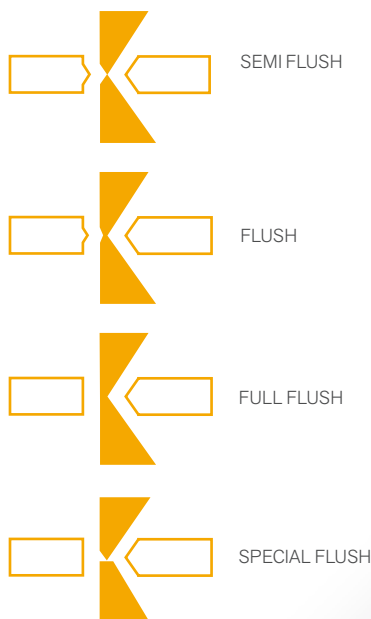

WIRE QUALITIES AND SYMBOLS

(N/mm² = tensile strength)

- soft wire: 220 - 250 N/mm²
- ⊘ medium hard wire: 750 - 800 N/mm²
- hard wire: 1600 - 1800 N/mm²
- Ⓟ Piano wire: 2200 - 2300 N/mm²

ESD ELECTRONIC PLIERS BLACKLINE

The pliers in the BLACKline series are characterised by their dip-insulated slender grips. They benefit from a comfortable feel and the pliers do not slip when held. They give the feeling that you are working very close to the workpiece and allow you to control cutting in an optimal manner.

The slim heads are ideal for working on delicate components and feature a highly polished, corrosion-resistant surface.

The smooth, box-jointed or single-jointed construction (depending on the model) guarantees a long service life if cared for properly.

The pliers have been tested with great results in accordance with DIN EN 61340-5-1, 61340-2-1 and 61340-2-3 as well as for work in ESD protected areas.



The following types are available, specifications in mm:

Art.-No.	Short description	Type	Flush	Cutting values				Head width	Cutting length	Total length	Weight in g
				○	◐	●	⊕				
CUTTING PLIERS											
▶ 3-901-7	ESD side cutters	-	Semi flush	1.5	1.0	0.4	-	12	10	115	65
3-902-7	ESD side cutters	-	Flush	1.5	0.8	-	-	12	10	120	65
3-905-7	ESD top cutters	-	Flush	0.8	0.6	-	-	13	3 x 20*	135	75
3-906-7	ESD end cutters	-	Flush	0.8	0.6	-	-	13	7 x 25*	125	75
HOLDING PLIERS											
									*jaw length		
▶ 3-932-7	ESD flat nose pliers	not serrated jaws	-	-	-	-	-	15	21.5	120	60
3-933-7	ESD snipe nose pliers	not serrated jaws	-	-	-	-	-	11.5	23	125	60
3-945-7	ESD snipe nose pliers	serrated jaws	-	-	-	-	-	12.5	12.5	145	85



► 3-960

ESD pliers set BLACKline 4 pcs

320 x 150 x 20 mm

Weight: 345 g

Art.-No.	Content
3-960-0	ESD dissipative bag 4 empty compartments
3-901-7	ESD side cutters BLACKline semi flush 115 mm
3-906-7	ESD end cutters BLACKline flush 125 mm
3-932-7	ESD flat nose pliers BLACKline not serrated jaws 120mm
3-933-7	ESD snipe nose pliers BLACKline not serrated jaws 125mm



3-960

► 3-960 VB

ESD tool kit BLACKline VARIO 6 pcs

150 x 145 x 80 mm

Weight: 750 g

Art.-No.	Content
5-090-0	ESD tool holder VARIO 8 slots
3-901-7	ESD side cutters BLACKline semi flush 115 mm
3-906-7	ESD end cutters BLACKline flush 125 mm
3-932-7	ESD flat nose pliers BLACKline not serrated jaws 120mm
3-933-7	ESD snipe nose pliers BLACKline not serrated jaws 125mm
5-078-13	ESD SMD universal tweezers 130mm form PSF stainless steel, dissipative
5-055-13	ESD SMD tweezers 120mm form 7a stainless steel angle 40°, dissipative



3-960 VB

ESD ELECTRONIC PLIERS CLASSICLINE

The pliers in the CLASSICline series are characterised by their high-gloss electropolished surface, which is very resistant to corrosion, without friction and microcracks, extremely smooth and free of particles. The heads are ideal for working on small components.

The pliers sit perfectly in the hand thanks to their two-component protective covering, which is ergonomically shaped, dissipative and features an individually adjustable double leaf spring. The smooth box joint guarantees a long service if cared for properly.

The pliers have been tested with great results in accordance with DIN EN 61340-5-1, 61340-2-1 and 61340-2-3, as well as for work in ESD protected areas.



The following types are available, specifications in mm:

Art.-No.	Short description	Type	Flush	Cutting values				Head width	Cutting length	Total length	Weight in g
				○	⊘	●	⊕				
▶ CUTTING PLIERS											
3-601-15	ESD side cutters	-	Semi flush	1.5	1.2	0.4	-	11	13	115	65
3-602-15	ESD side cutters	-	Flush	1.5	1.2	-	-	11	13	115	65
3-603-15	ESD side cutters	-	Semi flush	1.5	1.2	0.3	-	11	13	115	65
3-604-15	ESD side cutters	-	Flush	1.5	1.2	-	-	11	13	115	65
3-606-15	ESD side cutters	-	Flush	1.0	0.8	-	-	10.5	6	120	55
3-625-15	ESD oblique top cutters	-	Flush	1.5	1.2	-	-	11	11	120	90
3-627-15	ESD top cutters	-	Flush	1.5	1.2	-	-	11	11	120	90
▶ HOLDING PLIERS											
										jaw length	
3-631-15	ESD round nose pliers	not serrated jaws	-	-	-	-	-	10	20	120	55
3-632-15	ESD flat nose pliers	not serrated jaws	-	-	-	-	-	9	18.5	120	55
3-633-15	ESD snipe nose pliers	not serrated jaws	-	-	-	-	-	9.5	17.5	120	55
3-634-15	ESD snipe nose pliers	not serrated jaws	-	-	-	-	-	9.5	22.5	120	55

▶ 3-650 V

ESD pliers set CLASSICline VARIO 5 pcs

150 x 190 x 80 mm

Weight: 750 g

Art.-No.	Content
5-090-0	ESD tool holder VARIO 8 slots
3-601-15	ESD side cutters CLASSICline semi flush 115mm
3-631-15	ESD round nose pliers CLASSICline not serrated jaws 120 mm
3-632-15	ESD flat nose pliers CLASSICline not serrated jaws 120 mm
3-633-15	ESD snipe nose pliers CLASSICline not serrated jaws 120 mm
3-634-15	ESD snipe nose pliers CLASSICline not serrated jaws 120 mm



3-650 V

▶ 3-960 VC

ESD tool kit CLASSICline VARIO 6 pcs

150 x 180 x 80 mm

Weight: 700 g

Art.-No.	Content
5-090-0	ESD tool holder VARIO 8 slots
3-601-15	ESD side cutters CLASSICline semi flush 115 mm
3-606-15	ESD side cutters CLASSICline flush 120 mm
3-632-15	ESD flat nose pliers CLASSICline not serrated jaws 120 mm
3-633-15	ESD snipe nose pliers CLASSICline not serrated jaws 120 mm
5-078-13	ESD SMD universal tweezers 130mm form PSF stainless steel dissipative
5-055-13	ESD SMD tweezers 120mm form 7a stainless steel angle 40° dissipative



3-960 VC

▶ 3-960 C

ESD pliers set CLASSICline 4 pcs

320 x 150 x 20 mm

Weight: 380 g

Art.-No.	Content
3-960-0	ESD dissipative bag 4 empty compartments
3-601-15	ESD side cutters CLASSICline semi flush 115 mm
3-606-15	ESD side cutters CLASSICline flush 120 mm
3-632-15	ESD flat nose pliers CLASSICline not serrated jaws 120 mm
3-633-15	ESD snipe nose pliers CLASSICline not serrated jaws 120 mm



3-960 C

ESD ELECTRONIC PLIERS EUROLINE



The pliers in the EUROline series are characterised by the precision in manufacturing. The delicate, highly precise heads are produced by hand in a series of work steps. They are highly suitable for working on the smallest components or for cutting fine, strong wires. The high-gloss burnished surface guarantees resistance to corrosion and glare-free, fatigue-free work under the magnifier or microscope. The pliers sit perfectly in the hand thanks to their two-component protective covering, which is ergonomically shaped, dissipative and features an individually adjustable double leaf spring. The smooth box joint guarantees a long service if cared for properly. The pliers have been tested with great results in accordance with DIN EN 61340-5-1, 61340-2-1 and 61340-2-3, as well as for work in ESD protected areas.

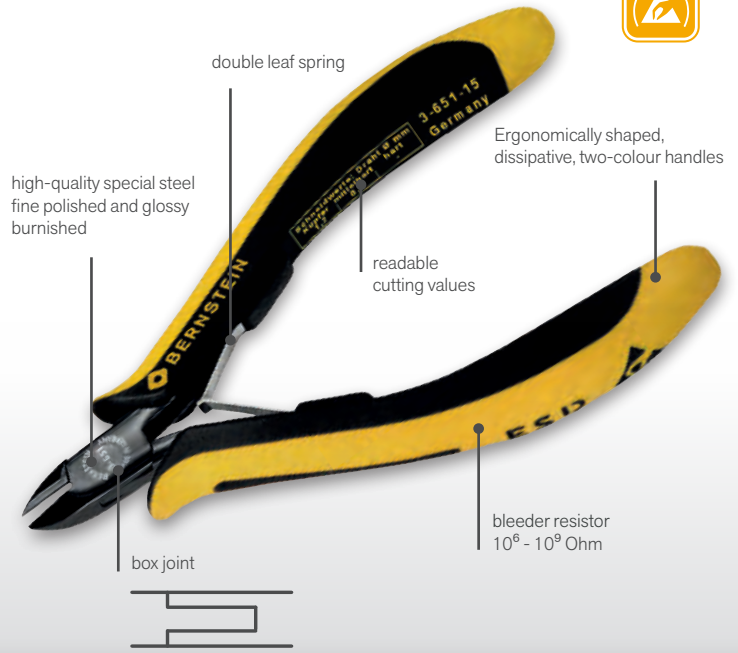

▶ 3-960 E

ESD pliers set EUROline 4 pcs

320 x 150 x 20 mm

Weight: 375 g

Also available as ESD dissipative zipper pocket Art.-No. 3-680.

Art.-No.	Content
3-960-0	ESD dissipative bag 4 empty compartments
3-651-15	ESD mini side cutters EUROline flush 120mm
3-672-15	ESD end cutters EUROline flush 130mm
3-682-15	ESD flat nose pliers EUROline not serrated jaws 130mm
3-683-15	ESD snipe nose pliers EUROline not serrated jaws 130mm



3-960 E

▶ 3-960 VE

ESD tool kit EUROline VARIO 6 pcs

150 x 90 x 80 mm

Weight: 375 g

Art.-No.	Content
5-090-0	ESD tool holder VARIO 8 slots
3-651-15	ESD mini side cutters EUROline flush 120mm
3-672-15	ESD end cutters EUROline flush 130mm
3-682-15	ESD flat nose pliers EUROline not serrated jaws 130mm
3-683-15	ESD snipe nose pliers EUROline not serrated jaws 130mm
5-078-13	ESD SMD universal tweezers 130mm form PSF stainless steel dissipative
5-055-13	ESD SMD tweezers 120mm form 7a stainless steel angle 40° dissipative



3-960 VE

▶ 3-960 ES

NEW

ESD pliers set EUROline 3 pcs

without container, loosely packed

Weight: 200 g

Art.-No.	Content
3-651-15	ESD mini side cutters EUROline flush 120mm
3-672-15	ESD end cutters EUROline flush 130mm
3-683-15	ESD snipe nose pliers EUROline not serrated jaws 130mm

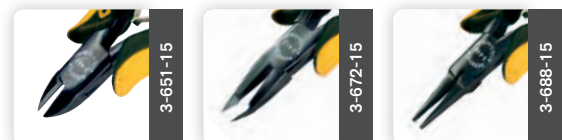

3-960 ES

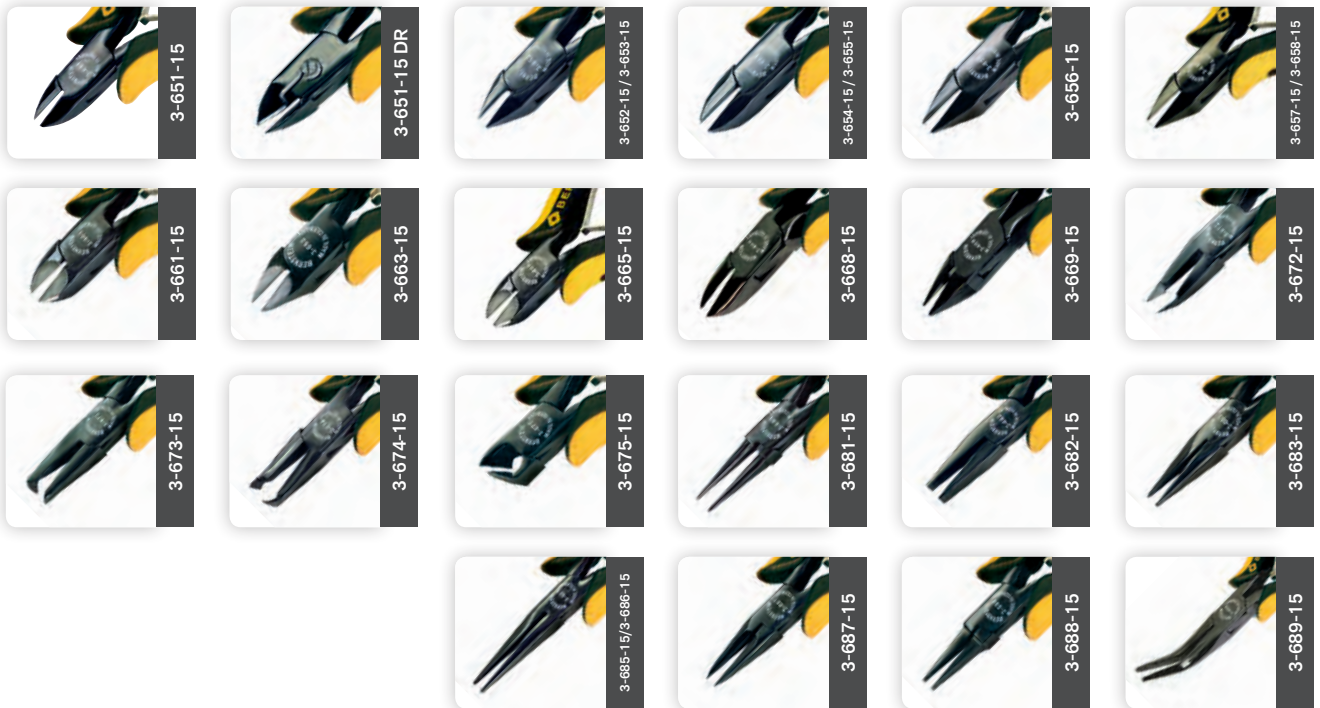

The following types are available, specifications in mm:

Art.-No.	Short description	Type	Flush	Cutting values				Head width	Cutting length	Total length	Weight in g
				○	◊	●	Ⓟ				
▶ CUTTING PLIERS											
3-651-15	ESD mini side cutters	-	Flush	1.5	0.8	-	-	10	9.5	120	65
3-651-15 DR	ESD mini side cutters	-	Flush	1.5	0.8	-	-	10	9.5	120	65
3-652-15	ESD mini side cutters	-	Flush	1.5	0.8	-	-	10	10	120	60
3-653-15	ESD mini side cutters	-	Flush	1.5	0.8	-	-	10	10	120	60
3-654-15	ESD side cutters	-	Semi flush	1.5	1.0	0.4	-	11	13	125	70
3-655-15	ESD side cutters	-	Flush	1.5	1.0	-	-	11	13	125	70
3-656-15	ESD side cutters	-	Semi flush	1.5	1.0	0.3	-	11	13	125	70
3-657-15	ESD side cutters	-	Flush	1.5	1.0	-	-	11	13	125	70
3-658-15	ESD side cutters	-	Full flush	1.5	0.6	-	-	11	13	125	70
3-661-15	ESD mini side cutters	with carbide insert	Semi flush	2.0	1.5	1.0	0.6	11	10	120	70
3-663-15	ESD mini side cutters	with carbide insert	Flush	1.8	1.3	0.8	0.4	11	10	120	65
3-665-15	ESD mini side cutters	with carbide insert	Special flush	only for glass fibre 2.0				11	10	120	65
3-668-15	ESD side cutters	-	Semi flush	2.0	1.5	0.7	-	14	17	135	110
3-669-15	ESD side cutters	-	Flush	2.0	1.5	-	-	14	17	135	110
3-672-15	ESD end cutters	-	Flush	0.8	0.6	-	-	10	5	130	70
3-673-15	ESD top cutters	-	Flush	0.8	0.6	-	-	10	5	130	60
3-674-15	ESD top cutters	-	Semi flush	0.8	0.6	-	-	10	5	130	60
3-675-15	ESD oblique top cutters	-	Flush	1.2	1.0	0.4	-	10	10	115	65
HOLDING PLIERS											
											jaw length
3-681-15	ESD round nose pliers	not serrated jaws	-	-	-	-	-	10	20	130	65
3-682-15	ESD flat nose pliers	not serrated jaws	-	-	-	-	-	10	20	130	70
3-683-15	ESD snipe nose pliers	not serrated jaws	-	-	-	-	-	10	23	130	70
3-685-15	ESD snipe nose pliers	not serrated jaws	-	-	-	-	-	10	32	140	70
3-686-15	ESD snipe nose pliers	serrated jaws	-	-	-	-	-	10	32	140	70
3-687-15	ESD snipe nose pliers	not serrated jaws	-	-	-	-	-	10	19	130	70
3-688-15	ESD flat nose pliers	not serrated jaws	-	-	-	-	-	8.5	18	130	60
3-689-15	ESD flat nose pliers	not serrated jaws	-	-	-	-	-	12	39	145	70

ESD ELECTRONIC PLIERS TECHNICLINE



The pliers in the TECHNICline series are characterised by their exceptional cutting performance. The precisely symmetrical, induction-hardened cutting edges have a hardness of 63-65 HRC and thus achieve particularly high cutting values, making them suitable for hard and special wires (HRC 81 made of tungsten carbide steel is also available on request). The matt-polished surface is scratch proof, glare free and non reflective.

The pliers sit perfectly in the hand thanks to their two-component protective covering, which is ergonomically shaped, dissipative and features an individually adjustable double leaf spring. The smooth screw joint can be readjusted, guaranteeing a long service life if cared for properly. **OBSERVE THE CARE INSTRUCTIONS**

The pliers have been tested with great results in accordance with DIN EN 61340-5-1, 61340-2-1 and 61340-2-3, as well as for work in ESD protected areas.



The following types are available, specifications in mm:

Art.-No.	Short description	Type	Flush	Cutting values				Head width	Cutting length	Total length	Weight in g
				○	◐	●	⊕				
▶ CUTTING PLIERS											
3-961-15	ESD side cutters	-	Semi flush	1.2	1.0	0.6	-	10	8	120	75
NEW 3-962-15	ESD side cutters	-	Flush	1.2	1.0	-	-	10	8	120	75
3-963-15	ESD side cutters	-	Full flush	1.0	0.8	-	-	10	8	120	75
3-964-15	ESD side cutters	-	Semi flush	1.2	1.0	0.6	-	10	8	120	75
3-966-15	ESD side cutters	-	Full flush	1.0	0.9	-	-	10	8	120	75
3-967-15	ESD side cutters	-	Semi flush	1.2	1.0	-	-	10	8	120	75
3-969-15	ESD side cutters	-	Full flush	0.8	0.4	-	-	10	8	120	75
NEW 3-971-15	ESD side cutters	-	Semi flush	1.6	1.3	0.7	-	12.5	10	125	80
NEW 3-972-15	ESD side cutters	-	Flush	1.6	1.2	-	-	12.5	10	125	80
3-973-15	ESD side cutters	-	Full flush	1.2	1.0	-	-	12.5	10	125	80
3-981-15	ESD end cutters	-	Full flush	0.8	0.6	-	-	10	20	135	80
3-985-15	ESD oblique top cutters	-	Flush	1.2	1.0	-	-	10	6.4	130	80
NEW 3-986-15	ESD side cutters	with carbide insert	Flush	HRC81 for hard wires				14.5	7.5	120	75
▶ HOLDING PLIERS											
								jaw length			
3-991-15	ESD round nose pliers	not serrated jaws	-	-	-	-	-	10	20	130	75
3-992-15	ESD flat nose pliers	not serrated jaws	-	-	-	-	-	10	20	130	75
NEW 3-993-15	ESD flat nose pliers	serrated jaws	-	-	-	-	-	10	20	140	75
3-996-15	ESD snipe nose pliers	not serrated jaws	-	-	-	-	-	10	30	140	80

► **Wire holder**

Wire catchers prevents the wire from falling between assemblies and components on circuit boards or into circuits. These cut wire pieces can cause serious damage. Suitable for side cutters for easy manual retrofitting.

Art.-No.	Side cutters for Art.-No.	For head width in mm	Weight in g
3-999-1	Art.-No. 3-961-15 to 3-696-15	10	9
3-999-2	Art.-No. 3-971-15 to 3-973-15	12.5	9

► **3-960 VT****ESD tool kit TECHNICline VARIO 6 pcs**

150 x 145 x 80 mm

Weight: 750 g

Art.-No.	Content
5-090-0	ESD tool holder VARIO 8 slots
3-963-15	ESD side cutters TECHNICline full flush 120mm
3-981-15	ESD end cutters TECHNICline full flush 135mm
3-992-15	ESD flat nose pliers TECHNICline not serrated jaws 130mm
3-996-15	ESD snipe nose pliers TECHNICline not serrated jaws 140mm
5-078-13	ESD SMD universal tweezers 130mm form PSF stainless steel dissipative
5-055-13	ESD SMD tweezers 120mm form 7a stainless steel angle 40° dissipative



3-960 VT

► **3-960 T****ESD pliers set TECHNICline 4 pcs**

320 x 150 x 20 mm

Weight: 410 g

Art.-No.	Content
3-960-0	ESD dissipative bag 4 empty compartments
3-963-15	ESD side cutters TECHNICline full flush 120mm
3-981-15	ESD end cutters TECHNICline full flush 135mm
3-992-15	ESD flat nose pliers TECHNICline not serrated jaws 130mm
3-996-15	ESD snipe nose pliers TECHNICline not serrated jaws 140mm



3-960 T

► **3-970 T****ESD pliers set TECHNICline 4 pcs**

320 x 150 x 20 mm

Weight: 410 g Also available as ESD dissipative zipper pocket (Art.-No. 3-970)

Art.-No.	Content
3-960-0	ESD dissipative bag 4 empty compartments
3-963-15	ESD side cutters TECHNICline full flush 120mm
3-971-15	ESD side cutters TECHNICline semi flush 125mm
3-992-15	ESD flat nose pliers TECHNICline not serrated jaws 130mm
3-996-15	ESD snipe nose pliers TECHNICline not serrated jaws 140mm



3-970 T

► **3-960 TS****NEW****ESD pliers set TECHNICline 3 pcs**

without container, loosely packed

Weight: 230 g

Art.-No.	Content
3-963-15	ESD side cutters TECHNICline full flush 120mm
3-981-15	ESD end cutters TECHNICline full flush 135mm
3-996-15	ESD snipe nose pliers TECHNICline not serrated jaws 140mm

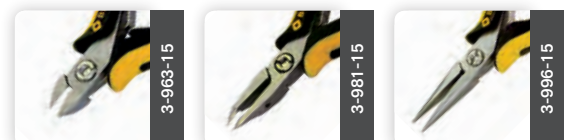

3-960 ES

ROBUST PLIERS



Material Q & T steel according to DIN
Cutting edges inductively hardened
The following types are available, specifications in mm:

Art.-No.	Short description	Type	Flush	Cutting values				Head width	Cutting/ jaw length	Total length mm	Weight in g
				○	⊘	●	Ⓟ				
3-235-16	Telephone pliers	serrated jaws	-	-	-	-	-	15	55	160	145
3-245-16	Telephone pliers	serrated jaws	-	-	-	-	-	18	75	205	210
3-255-16	Telephone pliers	serrated jaws	-	-	-	-	-	18	70	205	210
3-531-16	Flat nose pliers	serrated jaws	-	-	-	-	-	15	40	150	105
3-132-16	Side cutters	-	Full flush	4.0	2.3	1.5	-	15	16	130	125
3-133-16	Side cutters	-	-	4.0	2.5	1.8	-	18	18	150	155
3-732-16	Combination pliers	serrated jaws	-	4.0	2.5	2.0	-	23	35	170	205



The pliers of this program have been successfully tested by several testing laboratories according to DIN EN 61340-5-1, 61340-2-1, as well as 61340-2-3 for work in ESD-protected areas.

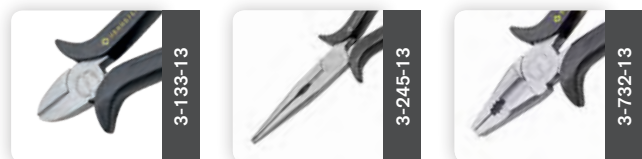

The following types are available, specifications in mm:

Art.-No.	Short description	Type	Flush	Cutting values				Head width	Cutting/ jaw length	Total length mm	Weight in g
				○	⊘	●	Ⓟ				
3-133-13	ESD side cutters	-	Semi flush	4.0	2.5	1.8	-	18	18	145	165
3-245-13	ESD telephone pliers	serrated jaws	Semi flush	-	-	-	-	18	75	200	180
3-732-13	ESD combination pliers	serrated jaws	Semi flush	4.0	2.5	1.8	-	23	35	165	185

PLIERS WITH SPECIAL REQUIREMENTS

▶ 3-734-13

NEW

ESD combination pliers, dissipative

The perfect tool for removing screws with defective screw heads safely and well. In contrast to conventional combination pliers, the gripping teeth (cutting) do not sit crosswise but lengthwise. Thus the jaws enclose the screw head perfectly and have a direct hold. This allows the screw to be unscrewed quickly and without slipping.

Made of special tool steel, matt polished, lap joint, with conductive hand protection cover.

ESD bleeder resistor 10^3 Ohm .

Suitable for screw heads 2.0 x 3.5 mm

Head width: 12 mm, total length: 120 mm, weight: 105 g



3-734-13



▶ 3-573

Water pump pliers 180mm with push-button

Size adjustable at the push of a button - thanks to the push button.

With extra slim head for hard-to-reach places

and protective, non-slip handles.

Total length: 180 mm, weight: 170 g



3-573



▶ 3-575-6

Water pump pliers 240 mm

Water pump pliers 240 mm, very stable, dip insulated, non-slip handles.

Total length: 240 mm, weight: 380 g



3-575-6

▶ 3-0641

Mini side cutters full flush for CU-wire up to Ø 1.0mm

Elektronik Seitenschneider mit Feder, ohne Schneidwate, für CU-Drähte bis Ø 1,0 mm / 18 AWG.

Gesamtlänge: 135 mm, Gewicht: 70 g



3-0641

▶ 3-0645

Stripping side cutters full flush for CU-Wire up to Ø 0.8mm

Stripping side cutter standard version, with spring, without cutting edge, for CU wires up to Ø 0.8 mm / 22-26 AWG.

Total length: 130 mm, weight: 80 g



3-0645

▶ 3-0648

Cable cutter up to Ø 10.5mm with lock function

Cable cutter, especially for coaxial cables, robust design, spring and locking device, for cables up to Ø 10.5 mm.

Total length: 170 mm, weight: 155 g



3-0648

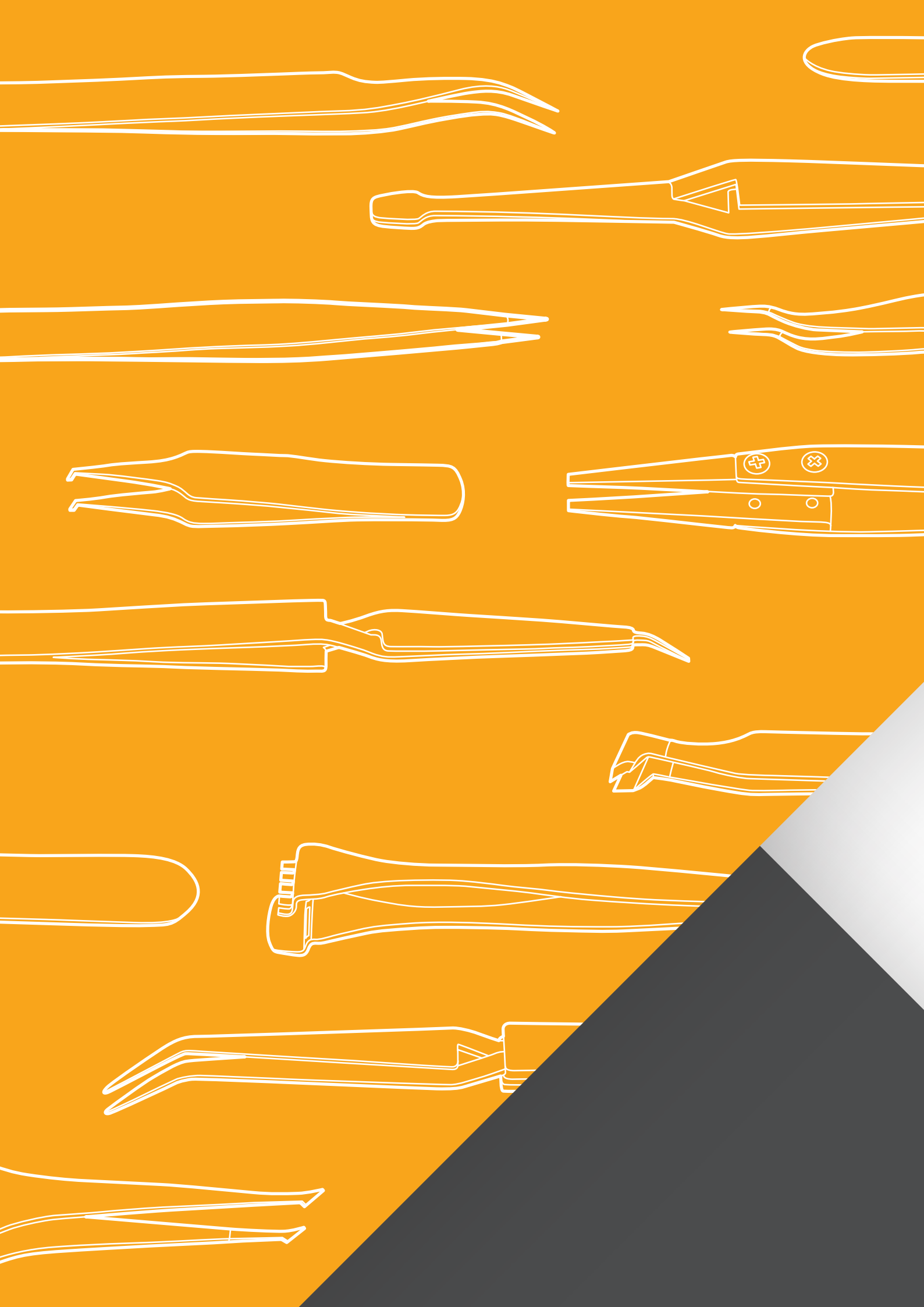

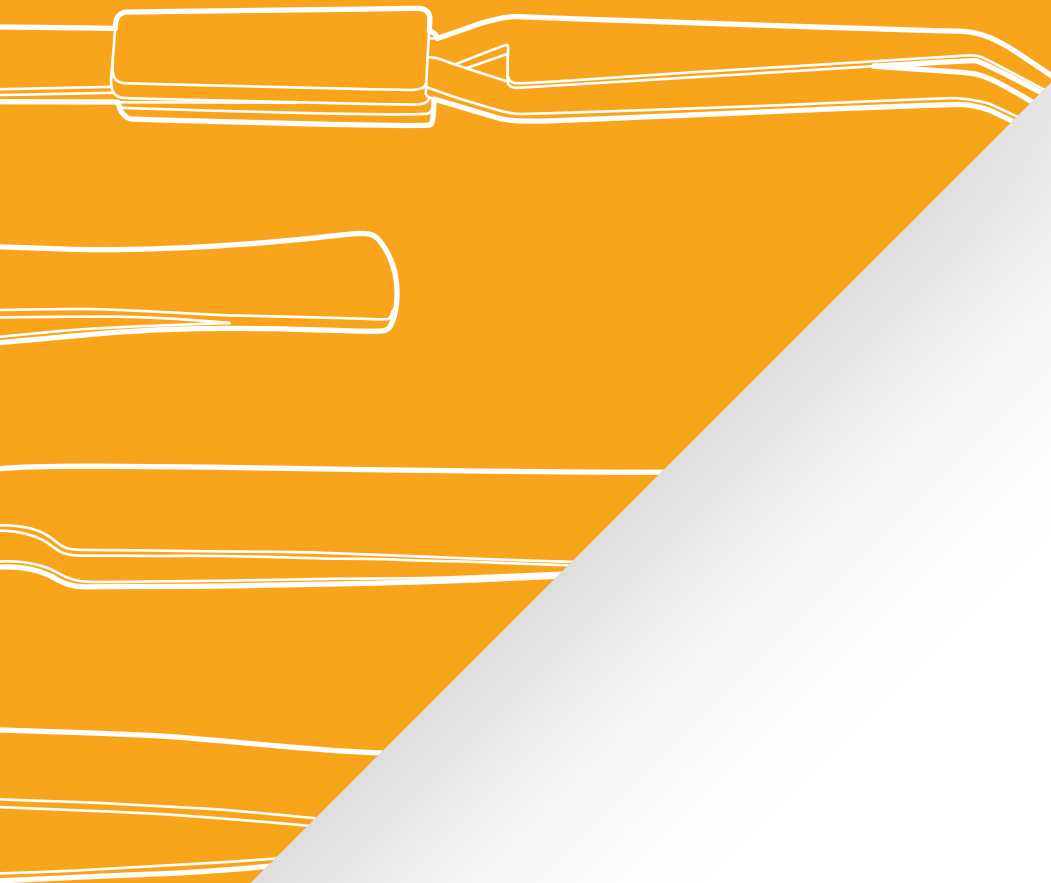

TWEEZERS – EVERYTHING IS UNDER CONTROL

The requirements for tweezers could not be more varied. For this reason, we are continuously expanding our range of tweezers with useful models, either through new designs or technically sophisticated materials.

Our tweezers are suitable for work on statically sensitive electronics in EPAs, clean rooms, the dental sector or laboratories, as well as for jewellers, watchmakers or in the craft trade.

BERNSTEIN tweezers meet the highest demands in quality, wherever they are used.

Get in touch with us if you can't find what you're looking for in the following pages.

Together we'll find the right tweezers for you.

sales@bernstein-werkzeuge.de

TWEEZERS - MATERIAL, FORM AND APPLICATION

TYPES AND APPLICATIONS

Our product selection ranges from microscope tweezers manufactured with exact tolerances (also recently available with ergonomically adapted, recessed grips) to interchangeable or cutting tips to all possible universal shapes and even locking tweezers.

Traditional tweezers are made from high-quality steel or stainless steel. We also manufacture tweezers made from titanium, ceramic, plastic and even bamboo.

The different surface finishes allow us to support a vast range of applications.

Delicate tweezers

SMD assembly requires the finest precision tweezers due to the increasingly smaller components. The variety of shapes and a parallel tip end enable reliable handling of components, even in confined spaces.

Delicate tweezers with grip

Tweezers with grips have the distinct advantage of allowing the user to keep focus while working under a microscope and not needing to look away to grip and hold the tweezers in the correct position.

Ultra-fine tweezers

For precise gripping, holding and positioning work with a tip width of 0.2 mm at a tolerance of +/-0.05.

Geometric tweezers

For easy removal and insertion of round or cubic components, every imaginable design is possible

Universal tweezers

Partially cut (small cross grooves on the tips) for better and stable gripping. They have precise, parallel tips and are used in the medical sector to remove foreign objects.

Wafer tweezers

For positioning flat and thin components, such as highly sensitive and fragile wafers (glass wafers, etc.), thin PCBs and LCDs.

Cutting tweezers

Best suited for soft wires up to \varnothing 0.25 mm, for example, copper wire, gold wire and silver wire.

Self-holding tweezers

Self-holding tweezers in different shapes are suitable for simple holding and positioning.

Tweezers with interchangeable tips

The tips are connected to the body by a screw joint, allowing them to be changed.



MATERIALS, SURFACE AND PROPERTIES

Stainless steel tweezers (SA)

Anti-magnetic, corrosion-resistant, resistant to acids and chemicals, good conductivity, very hygienic, sterilisable, food-safe, recyclable

Titanium tweezers (TI)

Anti-magnetic, corrosion-resistant, resistant to acids and chemicals, antibacterial, good conductivity, glare-free, solder-repellent, heat-resistant (melting point is 1677°C)

Quality steel (FE)

Protected from corrosion with nickel plating, not anti-magnetic, not resistance to acid.

ESD coating

Provides a bleeder resistance of $10^6 - 10^9$ ohms

VDE dip-insulation

For working with voltages up to 1000 V, in accordance with DIN IEC 60900 / EN 60900

Dip-insulated (red) or lacquered (red)

anti-allergic, non-slip, secure hold

PTFE coating

Heat resistant up to 280 °C (536 °F), anti-allergic

Bamboo (BA)

Tips are individually shapeable, non-conductive, partially chemical resistant, light in the hands

ESD ceramic zirconia (ZC)

Dissipative $10^6 - 10^9$ ohms, extremely wear resistant, heat resistant up to 800°, acid and chemical resistant, solder-repellent

Plastic ESD (PA)

Conductive between $10^3 - 10^5$ ohms, glass-fibre reinforced plastic material, resistant to acids, heat-resistant to 175 °C, free from silicone and armin

Carbofib (CF)

Carbon-fibre reinforced plastic, conductive $10^2 - 10^3$ ohms

Plastic (PP)

Low-priced alternative, insulating, good chemical resistance, high thermal stability, light in the hands.

Delrin (DEL)

Universal plastic, fully insulating $10^{13} - 10^{15}$ ohms

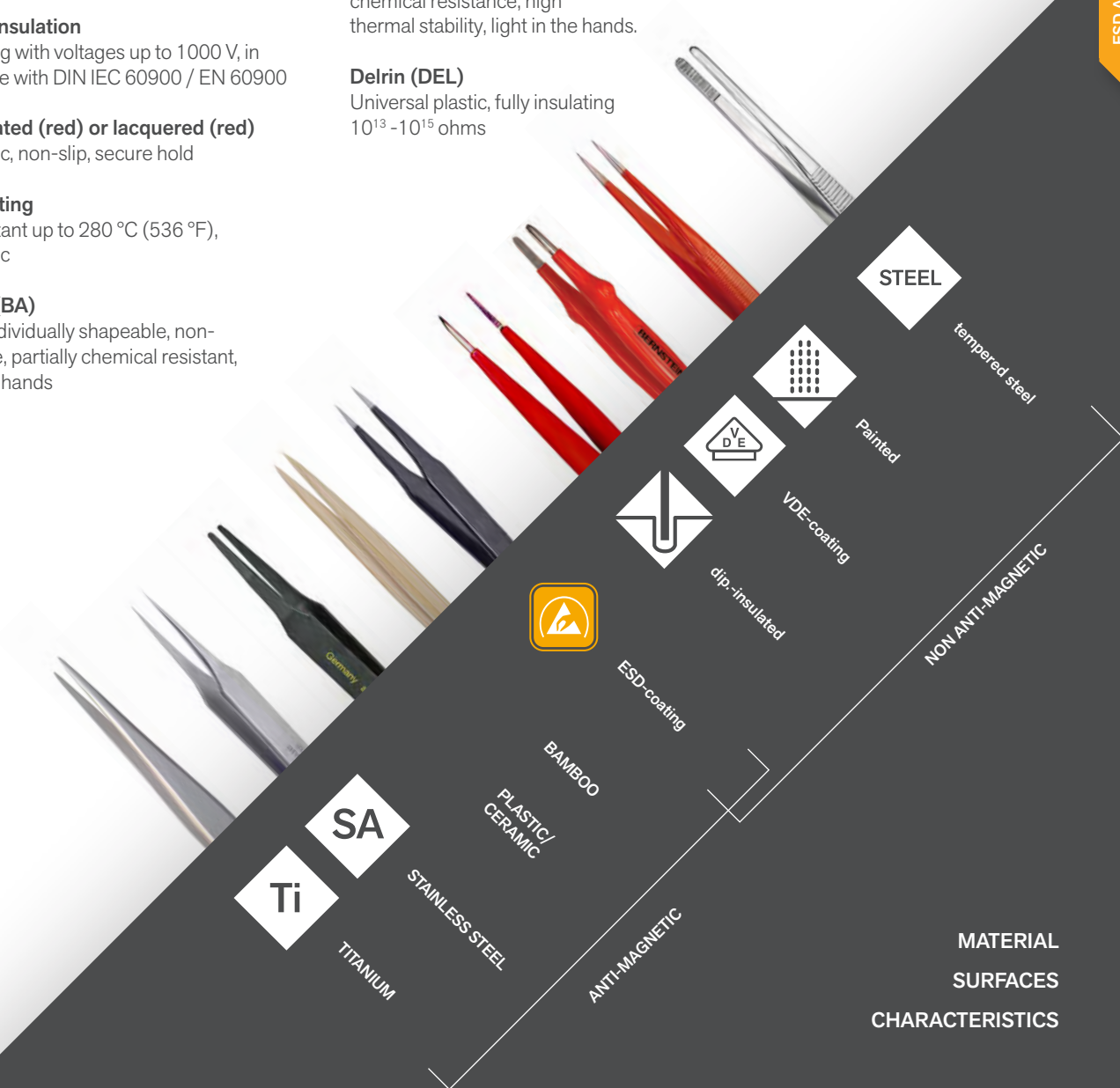

DELICATE TWEEZERS

SMD assembly requires the finest precision tweezers due to the increasingly smaller components. The variety of shapes and a parallel tip end enable reliable handling of components, even in confined spaces. In the electronics manufacturing, antimagnetic, acid and corrosion-resistant stainless steel (SA) is preferred with a particularly high strength, making the fine tips incredibly hard and resistant. Titanium and plastic are also popular materials.

Made from anti-magnetic, non-corrosive and acid-resistant stainless steel – non-reflective and matt-polished. The dissipative ESD coating provides a bleeder resistance of 10⁶–10⁹ ohms.



The following types are available, specifications in mm:

Art.-No.	Art.-No. 	Short description	Type	Material	Total length	Weight in g	
5-048	5-048-13	SMD tweezers	straight, very fine, tapered long tip approx. 30 mm	stainless steel	110	12	
5-049	5-049-13	SMD tweezers	straight, very fine, tapered long tip approx. 20 mm	stainless steel	110	15	
5-051	5-051-13	SMD tweezers	straight pointed, tapered approx. 30 mm	stainless steel	120	15	
5-052	5-052-13	SMD tweezers	30° angled very fine, tapered long tip approx. ca. 25 mm	stainless steel	120	15	
NEW	5-852	5-852-13	SMD tweezers	40° angled, very pointed, tapered	stainless steel	110	14
5-053	5-053-13	SMD tweezers	30° oblique, angled upwards, very fine long tip approx. 30 mm	stainless steel	110	13	
5-054	5-054-13	SMD tweezers	double bent, very sharp approx. 7/40 mm	stainless steel	120	15	
5-055	5-055-13	SMD tweezers	40° sickle-shaped, very-sharply pointed approx. 35 mm	stainless steel	120	15	
5-056	5-056-13	SMD tweezers	slightly bent, very-sharply pointed approx. 35 mm	stainless steel	120	15	
NEW	5-088	5-088-13	SMD tweezers	straight, oblique, very fine long tip approx. 35 mm	stainless steel	115	18
NEW	5-069	5-069-13	SMD tweezers	30° oblique, angled upwards, very fine long tip, serrated	stainless steel	115	15
NEW	5-089	5-089-13	SMD tweezers	stable, fillgree hook tip	stainless steel	115	17

► SMD tweezers set 6 pcs

Content: 5-051, 5-052, 5-054, 5-058, 5-061, 5-062

Art.-No.	Description	Weight in g
5-050	in a pocket (synthetic leather)	135
5-050-N	in a pocket (nylon)	110
5-050-ES	wihtout a pocket (loosley packed)	90
5-050-ST	with plastic stand (5-180-0)	110
5-050-V	with VARIO tool holder (5-090-1)	480

► ESD SMD tweezers set 6 pcs

Content: 5-049-13, 5-055-13, 5-059-13, 5-067-13, 5-068-13, 5-078-13

Art.-No.	Description	Weight in g
5-060	in a pocket (synthetic leather)	135
5-060-N	in a pocket (nylon)	110
5-060-ES	wihtout a pocket (loosley packed)	90
5-060-ST	with plastic stand (5-180-0)	110
5-060-V	with VARIO tool holder (5-090-0)	480



5-050



5-060

DELICATE TWEEZERS

STAINLESS STEEL

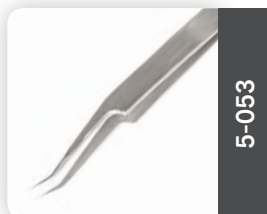
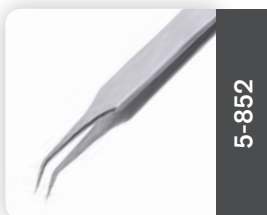
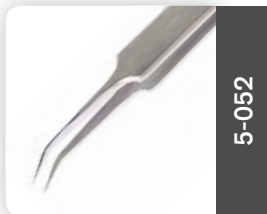
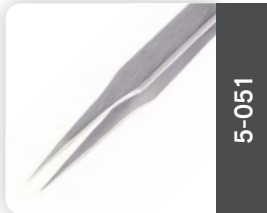

WITH ESD COATING

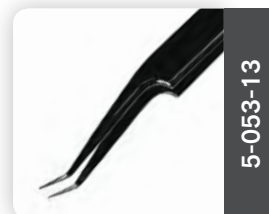
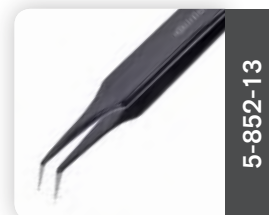
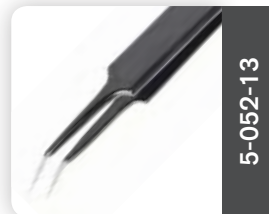
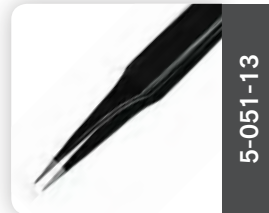
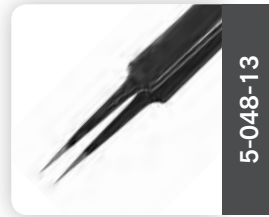

STAINLESS STEEL

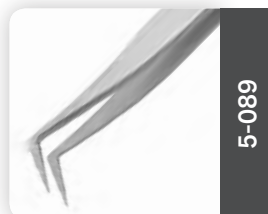
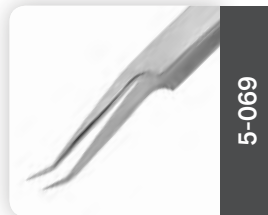
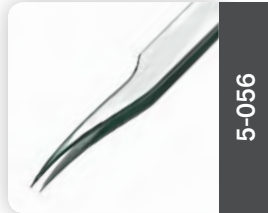
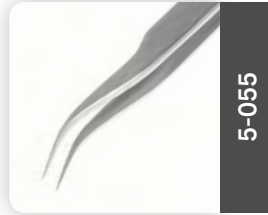
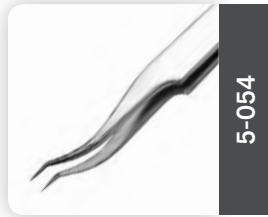

WITH ESD COATING

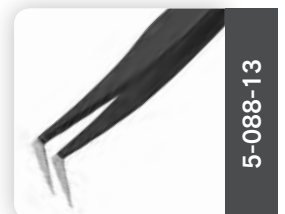
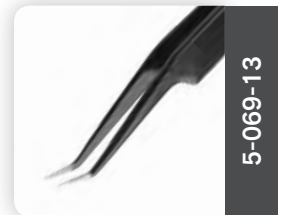
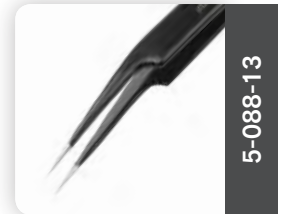
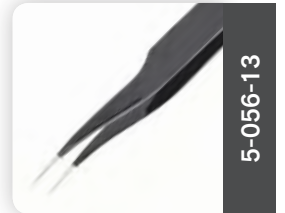
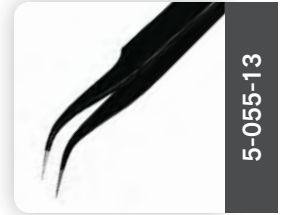

DELICATE TWEEZERS

The following types are available, specifications in mm:

Art.-No.	Art.-No. 	Short description	Type	Material	Total length	Weight in g	
5-071	5-071-13	MINI tweezers	straight, very stable slim form, very short	stainless steel	85	8	
NEW	5-086	5-086-13	MINI tweezers	straight, very stable wide form 10 mm, very short	steel	90	12
	5-072	5-072-13	universal tweezers	light type, stable fine tip, middle length	stainless steel	110	11
	5-073	5-073-13	universal tweezers	straight, long, slim, very pointed, very long	stainless steel	140	13
	5-074	5-074-13	universal tweezers	classic tweezers, straight pointed, stable form	stainless steel	120	14
	5-075	5-075-13	universal tweezers	straight, slim, tapered, reinforced tip, very long	stainless steel	140	13
	5-076	5-076-13	universal tweezers	straight pointed, classic tweezers, very stable type	stainless steel	120	19
	5-077	5-077-13	universal tweezers	long, very pointed and tapered	stainless steel	130	16
	5-078	5-078-13	universal tweezers	tapered 1.0 mm wide tip	stainless steel	130	20
	5-083	5-083-13	universal tweezers	tapered, large massive form	steel	140	8
NEW	5-085	5-085-13	universal tweezers	30° angled, slim, very pointed, very long	stainless steel	140	14
NEW	5-087	5-087-13	universal tweezers	short, stable form, tapered, non-slip	stainless steel	110	18
NEW	5-874	5-874-13	SMD tweezers	light type, slim tapered, very fine tip	stainless steel	120	14
NEW	5-878	5-878-13	SMD tweezers	sharp tapered 1 mm wide tip, serrated	stainless steel	130	19

DELICATE TWEEZERS SETS

NEW

► SMD tweezers set 6 pcs

Content: 5-049, 5-053, 5-055, 5-059, 5-078, 5-089

Art.-No.	Description	Weight in g
5-050-A	in a pocket (synthetic leather)	135
5-050-AN	in a pocket (nylon)	110
5-050-AES	without a pocket (loosely packed)	90
5-050-AST	with plastic stand (5-180-0)	110
5-050-AV	with VARIO tool holder (5-090-1)	480

► ESD SMD tweezers set 6 pcs

Content: 5-051-13, 5-052-13, 5-053-13, 5-059-13, 5-061-13, 5-077-13

Art.-No.	Description	Weight in g
5-060-A	in a pocket (synthetic leather)	135
5-060-AN	in a pocket (nylon)	110
5-060-AES	without a pocket (loosely packed)	90
5-060-AST	with plastic stand (5-180-0)	110
5-060-AV	with VARIO tool holder (5-090-0)	480

DELICATE TWEEZERS

STAINLESS STEEL

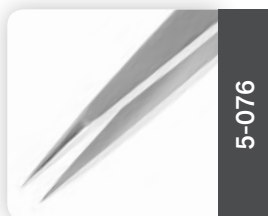
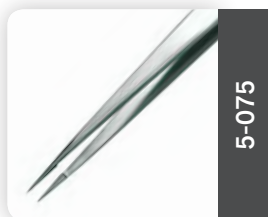
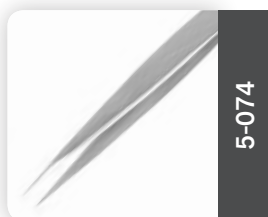
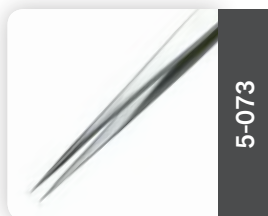
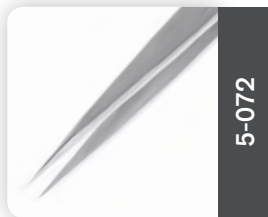
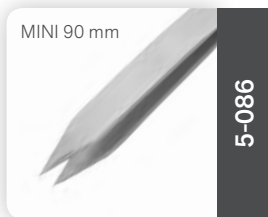
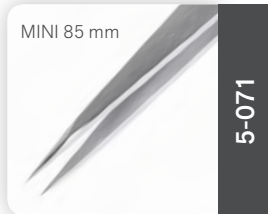

WITH ESD COATING

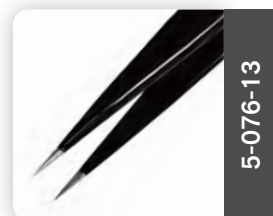
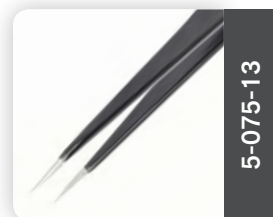
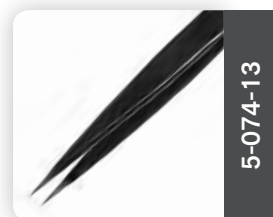
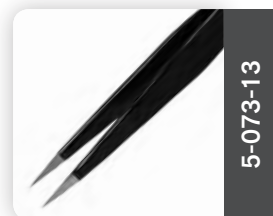
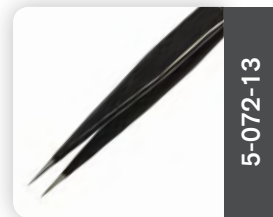
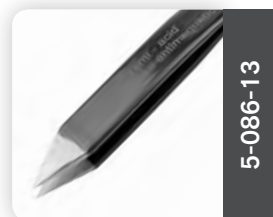
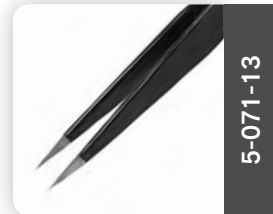

STAINLESS STEEL

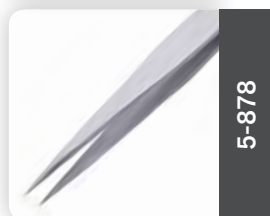
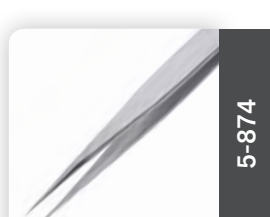
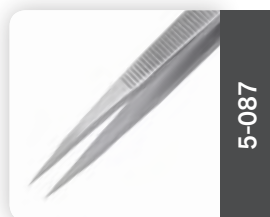
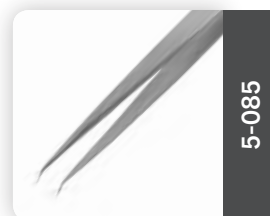
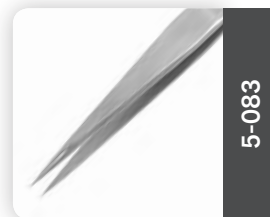
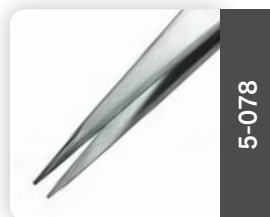
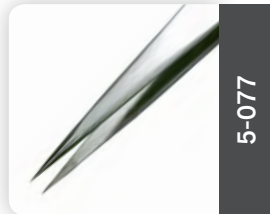

WITH ESD COATING

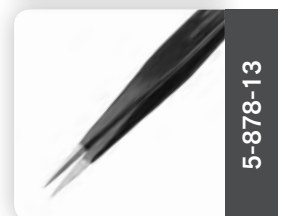
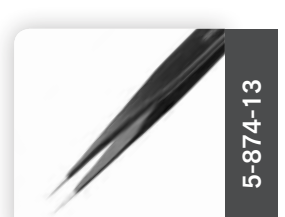
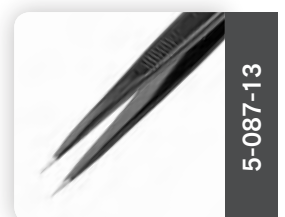
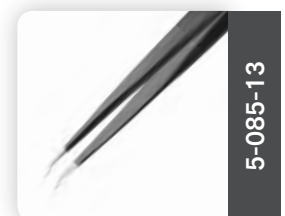
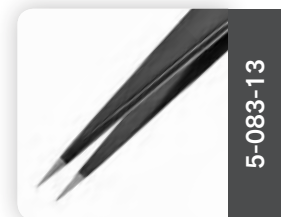
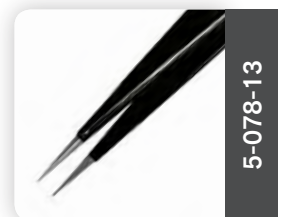
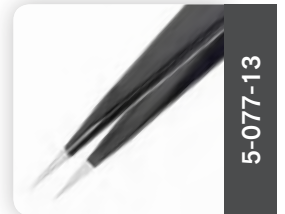

DELICATE TWEEZERS

NEW

Art.-No.	Art.-No. 	Short description	Type	Material	Total length	Weight in g
5-059	5-059-13	SMD tweezers	straight, rounded tip 2.0 mm wide	stainless steel	120	15
5-859	5-859-13	SMD tweezers	long, flat, angular tip 3 mm wide	stainless steel	125	17
5-061	5-061-13	SMD tweezers	30° angled, rounded tip 2.0 mm wide	stainless steel	115	16
5-861	5-861-13	SMD tweezers	30° bent, long, flat, angular tip 3 mm wide	stainless steel	120	17
5-862	5-862-13	SMD tweezers	30° bent upwards, rounded tip 2 mm wide	stainless steel	125	17
5-863	5-863-13	SMD tweezers	30° double bent, rounded tips 2 mm wide	stainless steel	125	17
5-864	5-864-13	SMD tweezers	flat, angular, bent upwards tip 5 mm wide, non-slip	stainless steel	105	14
5-865	5-865-13	SMD tweezers	spoon, flat, rounded tip 5 mm wide, non-slip	stainless steel	120	17
5-866	5-866-13	SMD tweezers	long, flat, rounded tip 4 mm wide, non-slip	stainless steel	120	17
5-867	5-867-13	SMD tweezers	flat, angular tip 5 mm wide, non-slip	stainless steel	120	17

STAINLESS STEEL

WITH ESD COATING

STAINLESS STEEL

WITH ESD COATING

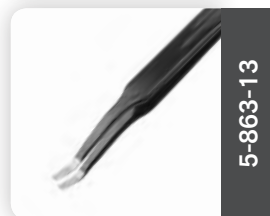
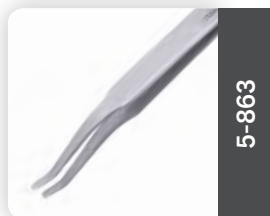
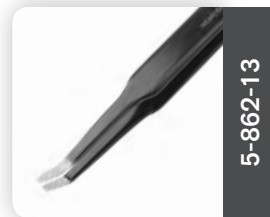
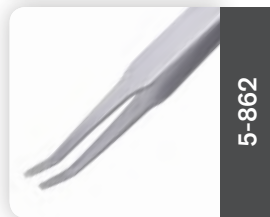
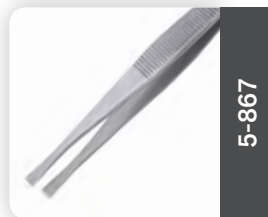
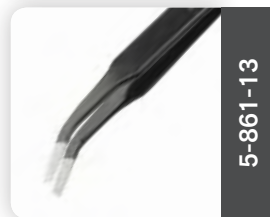
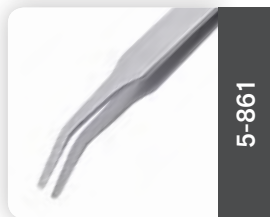
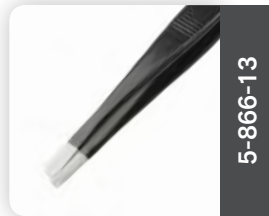
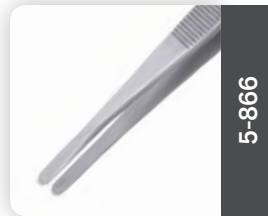
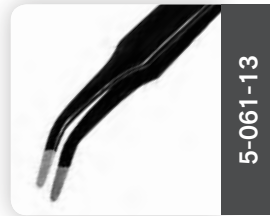
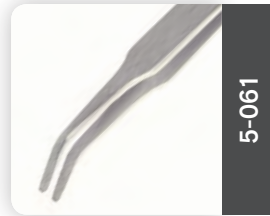
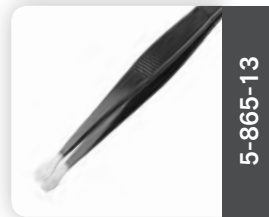
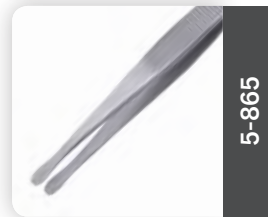
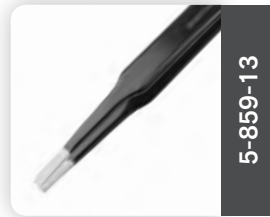
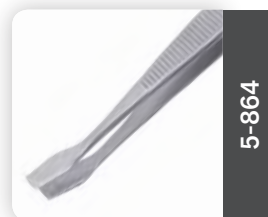
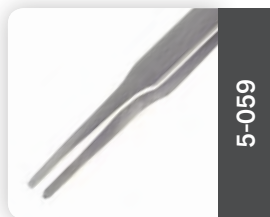

DELICATE TWEEZERS WITH GRIP

NEW



Tweezers with grips have the distinct advantage of allowing the user to keep focus while working under a microscope and not needing to look away to grip the tweezers in the correct position. In addition, they guarantee steady positioning.

A special feature of the Touch Point tweezers is their ergonomically shaped grip points, which enable precise and repeatable gripping. Moreover, the user needs about 20% less bending force due to the grip, reducing the effects of long-term stress. They reduce the manual force by approximately 33% compared to conventional tweezers performing the same work. This reduces the pressure applied to components to a minimum.

Made from anti-magnetic, non-corrosive and acid-resistant stainless steel – non-reflective and matt-polished. Dissipative ESD coating available on request.

The following types are available, specifications in mm:

Art.-No.	Short description	Type	Material	Total length	Weight in g
5-048-TP	Touch Point Tweezers	straight, very fine, tapered long tip	stainless steel	110	12
5-052-TP	Touch Point Tweezers	30° angled, very fine, tapered long tip	stainless steel	110	15
5-053-TP	Touch Point Tweezers	30° oblique bent upwards, very fine long tip	stainless steel	120	18
5-077-TP	Touch Point Tweezers	long, stable, extra pointed	stainless steel	130	16
5-082-TP	Touch Point Tweezers	short, straight, wide tip with heel	stainless steel	95	12
5-088-TP	Touch Point Tweezers	straight, light oblique, very fine long tip	stainless steel	120	18

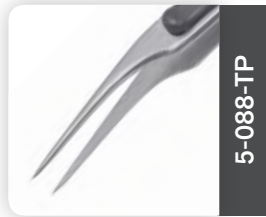
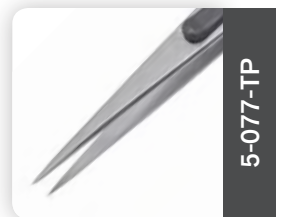
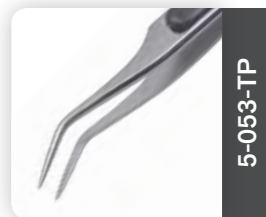
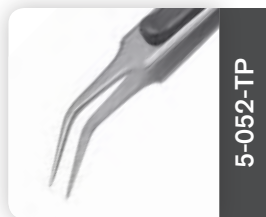
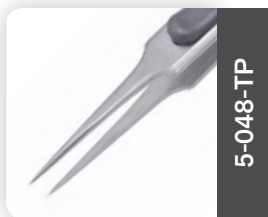

► 5-010-ATP

NEW

Touch Point tweezers set 3 pcs

in a pocket (nylon)

Content: 5-048-TP, 5-052-TP, 5-082-TP, 5-030-0

Weight: 59 g

► 5-010-BTP

NEW

Touch Point tweezers set 3 pcs

in a pocket (nylon)

Content: 5-088-TP, 5-053-TP, 5-077-TP, 5-030-0

Weight: 78g



5-010-ATP

5-010-BTP

ULTRA FINE TIPPING TWEEZERS

NEW

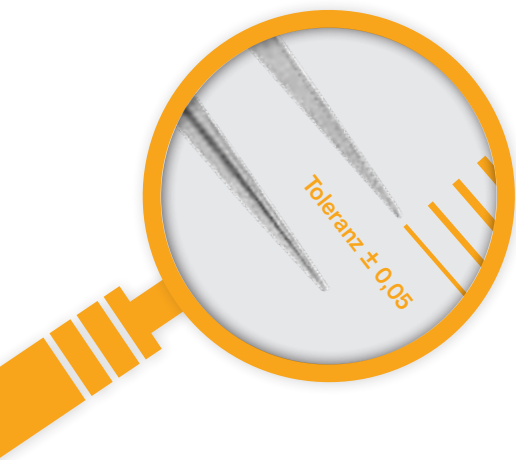

▶ ULTRA FINE tipping tweezers

For precise gripping, holding and positioning work in laboratories, test facilities and, above all, under the microscope. Featuring a tip width of 0.2 mm at a tolerance of +/-0.05, even robots can be equipped with them (pick-and-place), enabling a configuration with high repetition accuracy.

Made from anti-magnetic, non-corrosive and acid-resistant stainless steel – non-reflective and matt-polished. The dissipative ESD coating provides a bleeder resistance of 10⁶-10⁹ ohms.

The following types are available, specifications in mm:

Art.-No.	Art.-No. 	Short description	Type	Material	Total length	Weight in g
5-049-UF	5-049-UF-13	SMD tweezers ULTRA FINE	straight, very pointed, tapered	stainless steel	110	15
5-051-UF	5-051-UF-13	SMD tweezers ULTRA FINE	straight, very pointed, slim tapered	stainless steel	120	15
5-052-UF	5-052-UF-13	SMD tweezers ULTRA FINE	30° angled, very fine tapered	stainless steel	110	15
5-055-UF	5-055-UF-13	SMD tweezers ULTRA FINE	40° sickle-shaped, very pointed	stainless steel	120	15
5-072-UF	5-072-UF-13	Universal tweezers ULTRA FINE	slim type, very fine	stainless steel	110	11
5-078-UF	5-078-UF-13	Universal tweezers ULTRA FINE	tapered	stainless steel	130	20

STAINLESS STEEL

WITH ESD COATING

STAINLESS STEEL

WITH ESD COATING

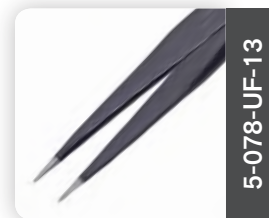
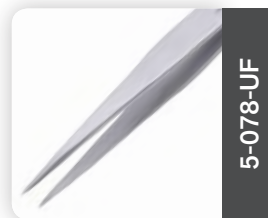
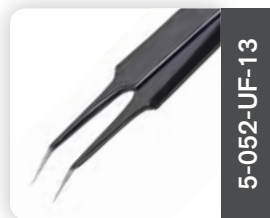
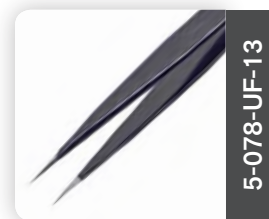
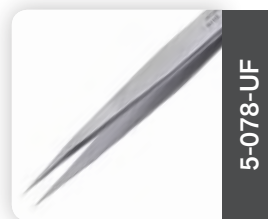
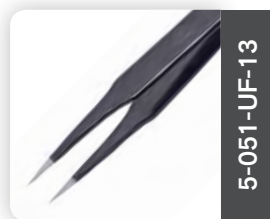
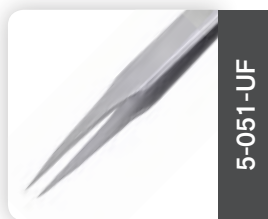
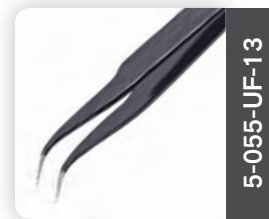
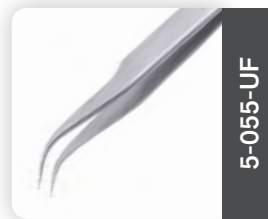
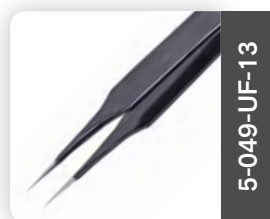
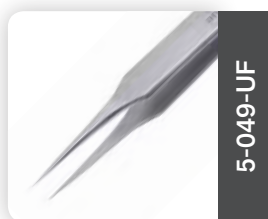

ULTRA FINE TIPPING TWEEZERS SETS

▶ **5-070-UF**

NEW

SMD tweezers set ULTRA FINE 6 pcs

in a pocket (synthetic leather)
Content: 5-049-UF, 5-051-UF, 5-052-UF, 5-055-UF,
5-072-UF, 5-078-UF

Weight: 150 g

▶ **5-070-UF-13**

NEW

ESD SMD tweezers set ULTRA FINE 6 pcs

in a pocket (synthetic leather)
Content: 5-049-UF-13, 5-051-UF-13, 5-052-UF-13,
5-055-UF-13, 5-072-UF-13, 5-078-UF-13

Weight: 150 g



5-070-UF



5-070-UF-13



TITANIUM TWEEZERS



▶ **TITANIUM tweezers**

Tweezers made of titanium material are antimagnetic, corrosion-resistant, acid- and chemical resistant, antibacterial, highly conductive, glare-free, solder repellent, heat resistant (melting point at 1677° C), matt polished

The following types are available, specifications in mm:

Art.-No.	Short description	Type	Material	Total length	Weight in g
5-031	TITAN tweezers	straight, very fine, tapered long tip	titan	110	9
5-035	TITAN tweezers	light type, slim tapered, fine tip	titan	120	9
5-036	TITAN anatomical tweezers	long, straight, rounded tip, serrated	titan	145	15
5-037	TITAN anatomical tweezers	long, guiding pin, angled, fine tip, serrated	titan	150	12
5-051-Ti	TITAN tweezers	straight, very pointed, slim tapered	titan	125	10
5-055-Ti	TITAN tweezers	40° sickle-shaped, very pointed	titan	125	10
5-059-Ti	TITAN tweezers	straight, rounded tip 2.0 mm wide	titan	125	10
5-078-Ti	TITAN tweezers	tapered	titan	130	10

▶ **5-030**

TITAN tweezers set 3 pcs

in a pocket (synthetic leather)
Content: 5-031, 5-036, 5-037
Weight: 70 g



5-030

▶ **5-030-A**

NEW

TITAN tweezers set 3 pcs .

in a pocket (synthetic leather)
Content: 5-051-Ti, 5-055-Ti, 5-059-Ti
Weight: 55 g

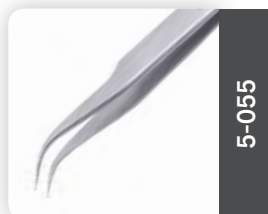

5-055

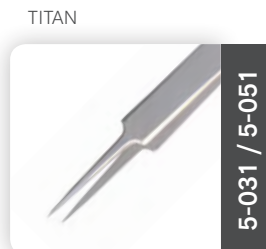

5-031 / 5-051

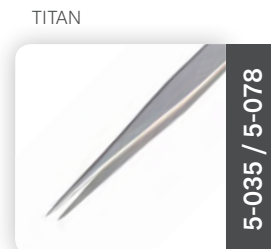

5-035 / 5-078

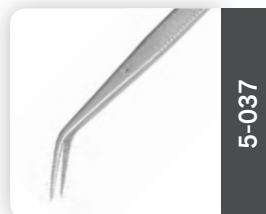

5-037

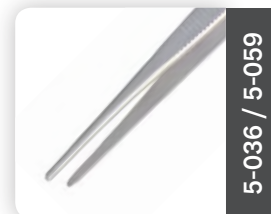

5-036 / 5-059

GEOMETRIC TWEEZERS

Every imaginable shape is possible. Bulbous or long, hollow tweezers with the appropriate diameter are suitable for the easy removal or insertion of round or cubic component parts. PVC dip-insulation on the tips protect sensitive parts made from plastic or glass such as laser optics or other opto-mechanical components.

Made from quality steel (nickel-plated, not anti-magnetic) or made from Stainless steel (anti-magnetic, non-corrosive and acid-resistant, non-reflective and matt-polished).

The dissipative ESD coating provides a bleeder resistance of 10^6 - 10^9 ohms.

Additional models with dissipative ESD coating on request.

The following types are available, specifications in mm:

Art.-No.	Art.-No. 	Short description	Type	Material	Total length	Weight in g
2-601	2-601-13	IC tweezers	for gripping, inserting and pulling out of ICs	nickel-plated steel	125	21
2-601-7		IC tweezers	for gripping, inserting and pulling out of ICs	stainless steel	125	21
5-006		component tweezers	straight, rectangular insulated gripper jaws 5 mm, non-slip	insulated steel	125	21
5-006-7	5-006-7-13	assembly tweezers	socket 5 mm wide, 10 mm long, gripper jaws spoonful	stainless steel	145	23
5-007	5-007-13	assembly tweezers	straight, gripper jaws 5 mm wide, Ø 5 mm	nickel-plated steel	145	23
5-008		assembly tweezers	straight, gripper jaws 5 mm wide, non-slip	nickel-plated steel	145	22
5-009		assembly tweezers	straight, flat insulated gripper jaws 5.5 mm wide, non-slip	insulated steel	145	25
5-013-7	5-013-7-13	assembly tweezers	45° diagonal socket Ø 1.5 mm, wide 5 mm	stainless steel	125	15
5-014-7	5-014-7-13	assembly tweezers	socket Ø 3 - 5 mm, wide 4 mm, gripper jaws round bulbous	stainless steel	120	15
5-015-7	5-015-7-13	assembly tweezers	socket Ø 6 - 10 mm, wide 4 mm, gripper jaws round bulbous	stainless steel	120	15
5-016-7	5-016-7-13	assembly tweezers	socket 2 mm wide, 10 mm long, gripper jaws spoonful	stainless steel	125	15
5-062	5-062-13	SMD tweezers	tip width 1.5 mm, gripping recess Ø 0.8 mm, angled 35°	stainless steel	115	16
5-063	5-063-13	SMD tweezers	tip width 3.0 mm, gripping recess Ø 0.8 mm, angled 35°	stainless steel	115	16
5-064	5-064-13	SMD tweezers	tip width 1.5 mm, gripping recess Ø 0.8 mm, straight	stainless steel	120	16
5-065	5-065-13	SMD tweezers	tip width 3.0 mm, gripping recess Ø 0.8 mm, straight	stainless steel	120	16
5-066	5-066-13	SMD tweezers	tip 30° angled, 2.5 mm wide	stainless steel	120	15
5-067	5-067-13	SMD tweezers	tip 45° angled, 2.0 mm wide	stainless steel	120	15
5-068	5-068-13	SMD tweezers	tip 45° angled, 2.0 mm oblique	stainless steel	120	13
5-114-7	5-114-7-13	thermal tweezers	with copper jaws 5 x 11 mm	stainless steel	145	23

NEW

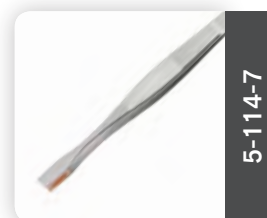
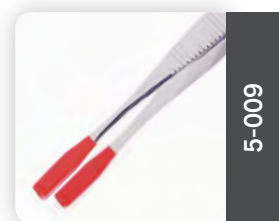
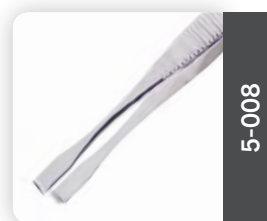
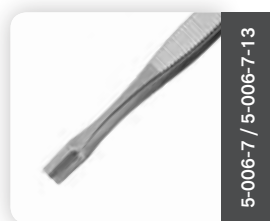
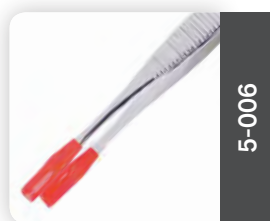
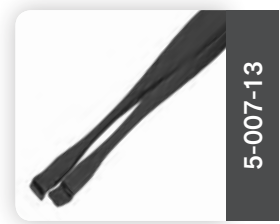
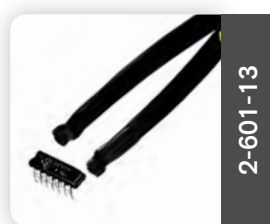

S. 71 CROSS THERMAL Tweezers

GEOMETRIC TWEEZERS

STAINLESS STEEL

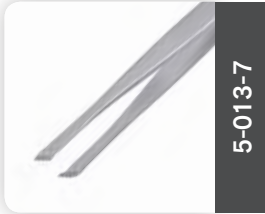

5-013-7

WITH ESD COATING



5-013-7-13



5-014-7



5-014-7-13

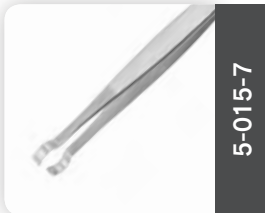

5-015-7

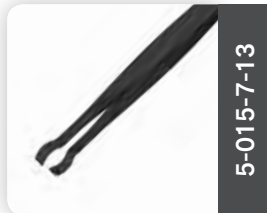

5-015-7-13



5-016-7

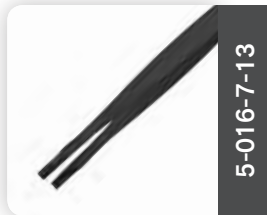

5-016-7-13

NEW

STAINLESS STEEL



5-062

WITH ESD COATING



5-062-13



5-063



5-063-13

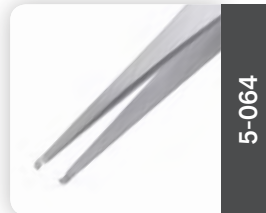

5-064

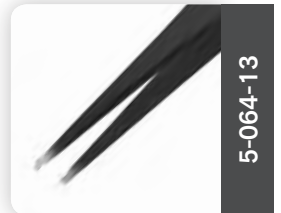

5-064-13

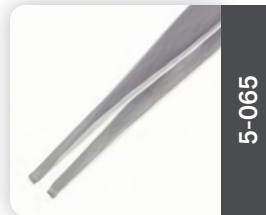

5-065



5-065-13

SETS

NEW

► 5-130

Geometric tweezers set 3 pcs

in a pocket (synthetic leather)

Content: 5-066-13, 5-067-13, 5-068-13

Weight: 90 g

► 5-130-A

Geometric tweezers set 3 pcs

in a pocket (synthetic leather)

Content: 5-013-7-13, 5-014-7-13, 5-062-13

Weight: 95 g

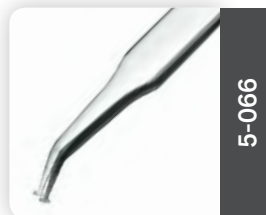

5-066

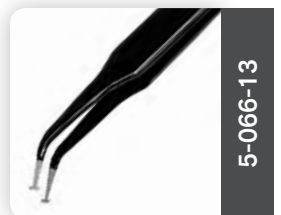

5-066-13

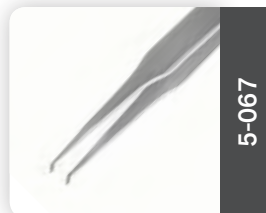

5-067

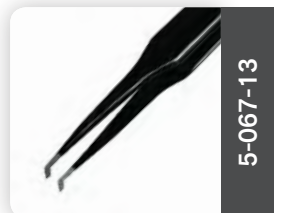

5-067-13

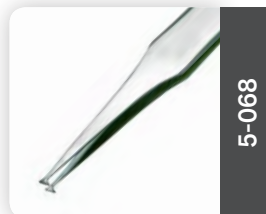

5-068

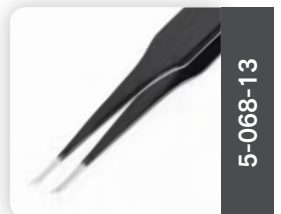

5-068-13



UNIVERSAL TWEEZERS

Anatomic tweezers are somewhat larger due to their main body and are partially cut (small cross grooves on the tips) for better and stable gripping. They have precise, parallel tips and are used in the medical sector to remove foreign objects. Bent, slightly angled models provide support for work in the laboratory with ergonomic positioning for high grip repetition.

Made from quality steel (nickel-plated, not anti-magnetic) or made from Stainless steel (anti-magnetic, non-corrosive and acid-resistant, non-reflective and matt-polished). The dissipative ESD coating provides a bleeder resistance of 10^6 – 10^9 ohms.

Additional models with dissipative ESD coating on request.

The following types are available, specifications in mm:

Art.-No.	Art.-No. 	Short description	Type	Material	Total length	Weight in g
NEW 5-106-7	5-106-7-13	anatomical tweezers	long, with guiding pin, very fine and stabel tip, serrated	stainless steel	155	20
5-107		anatomical tweezers	long, with guiding pin, angled, fine tip serrated	nickel-plated steel	150	20
5-107-1		anatomical tweezers	long, with guiding pin, angled, fine tip serrated	painted steel	150	23
5-107-6		anatomical tweezers	long, with guiding pin, angled, fine tip serrated	dip insulated steel	150	27
5-107-7	5-107-7-13	anatomical tweezers	long, with guiding pin, angled, fine tip serrated	nickel-plated steel	155	28
5-107-9		anatomical tweezers	long, with guiding pin, angled, fine tip serrated	steel PTFE	150	22
5-117		anatomical tweezers	long, straight, rounded tip, serrated	nickel-plated steel	145	25
5-117-1		anatomical tweezers	long, straight, rounded tip, serrated	painted steel	145	26
5-117-6		anatomical tweezers	long, straight, rounded tip, serrated	dip insulated steel	145	31
5-117-7	5-117-7-13	anatomical tweezers	long, straight, rounded tip, serrated	stainless steel	155	20
5-117-9		anatomical tweezers	long, straight, rounded tip, serrated	steel PTFE	145	29
5-119		anatomical tweezers	long, straight, rounded tip, serrated	nickel-plated steel	140	19
5-121		anatomical tweezers	short, straight, fine tip, serrated	nickel-plated steel	120	14
5-121-1		anatomical tweezers	short, straight, fine tip, serrated	painted steel	120	14
5-121-6		anatomical tweezers	short, straight, fine tip, serrated	dip insulated steel	120	17
5-121-7	5-121-7-13	anatomical tweezers	short, straight, fine tip, serrated	stainless steel	120	14
5-121-9		anatomical tweezers	short, straight, fine tip, serrated	steel PTFE	120	13
5-125		universal tweezers	light type, tapered	dip insulated steel	110	12
5-107 VDE		mechanic tweezers	VDE insulated, angled, fine tip, serrated with VDE protective insulation according to VDE standard	 dip insulated steel	150	37
5-117 VDE		mechanic tweezers	VDE insulated, straight, rounded tip, serrated with VDE protective insulation according to VDE standard	 nickel-plated steel	145	39
5-020		bamboo tweezers	long slim form, pointed, universal use, individually formable, non conductive, non magnetic, partly chemical resistant	bamboo	150	4

► 5-110

Universal tweezers set 3 pcs.

in a pocket (synthetic leather), anatomical and cross tweezers

Content: 5-107, 5-121, 5-155

Weight: 95 g



5-110



NICKEL-PLATED STEEL



PAINTED STEEL



DIP INSULATED STEEL



STAINLESS STEEL

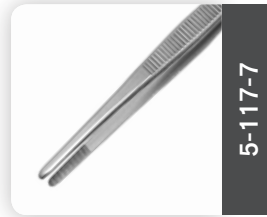
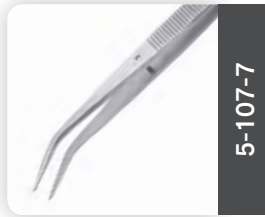
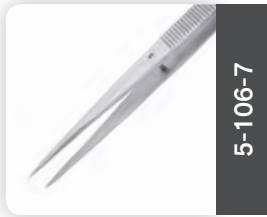

ESD

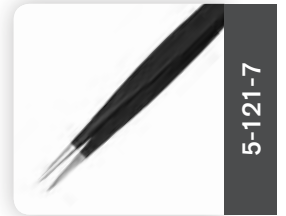
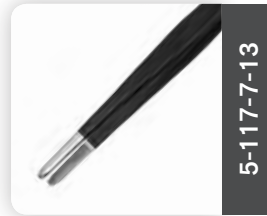
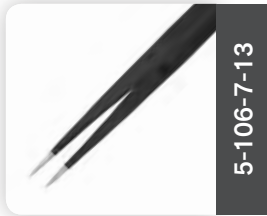

STEEL PTFE COATED

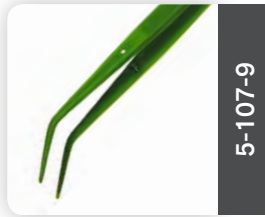

VDE

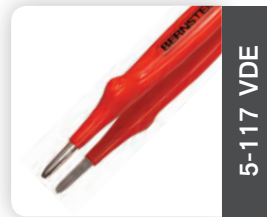
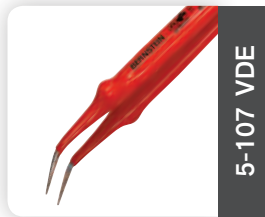

BAMBOO

NEW

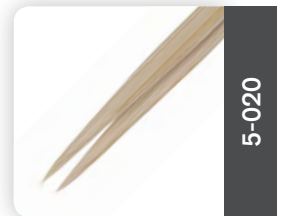

WAFER TWEEZERS

For positioning flat and thin components, such as highly sensitive and fragile wafers (glass wafers, etc.), thin PCBs and LCDs.

Made from anti-magnetic, non-corrosive and acid-resistant stainless steel – non-reflective and matt-polished. The dissipative ESD coating provides a bleeder resistance of 10^6 – 10^9 ohms.



All types are available with a ESD-coating (-13)

The following types are available, specifications in mm:

Art.-No.	Art.-No.	Short descriptin	Type	Material	A	B	C	D	E	for Wafer in inch	Total length	Weight in g
5-411	5-411-13	wafer tweezers	3 teeth, slim	stainless steel	6	6	4	4	3,2	2	130	14
5-412	5-412-13	wafer tweezers	3 teeth	stainless steel	9	6	2,5	3	3,2	2	130	14
5-413	5-413-13	wafer tweezers	4 teeth	stainless steel	12	8	4	5	3,2	3	130	17
5-414	5-414-13	wafer tweezers	5 teeth	stainless steel	16	6	4	5	3,2	4-5	130	20
5-415	5-415-13	wafer tweezers	6 teeth	stainless steel	20	8	4	5	3,2	6	130	20
5-421	5-421-13	wafer tweezers	without teeth	stainless steel	6	6	4	5	3	2	130	14
5-422	5-422-13	wafer tweezers	without teeth	stainless steel	12	8	4	5	3	3	130	17
5-423	5-423-13	wafer tweezers	without teeth	stainless steel	16	8	4	4	3	4-5	130	20
5-424	5-424-13	wafer tweezers	without teeth	stainless steel	20	8	4	5	3,5	6	130	20

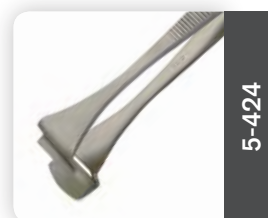
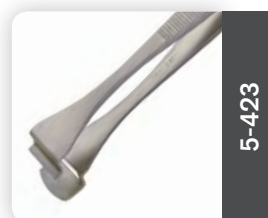
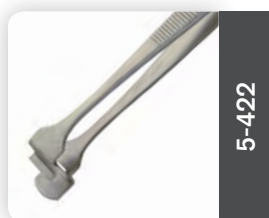
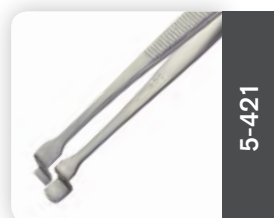
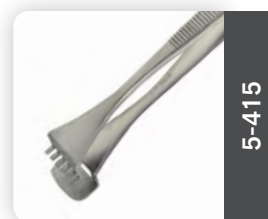
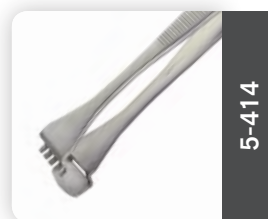
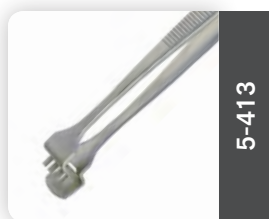
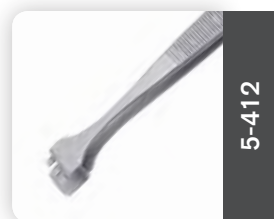
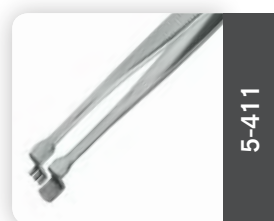
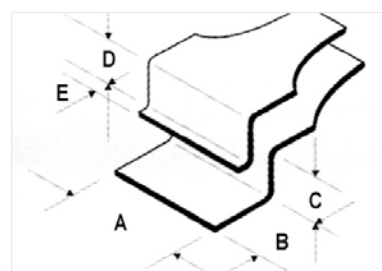

CUTTING TWEEZERS



Made from high-quality carbon steel (INOX).
CARE INSTRUCTIONS: Carbon steel rusts in high humidity or if touched with fingers (sweat). For this reason, tweezers should always be kept dry or rubbed with oil if stored for longer periods.

If a film of rust still forms on the tweezers or blades, it can be easily removed by lightly sanding the affected area.
The dissipative ESD coating provides a bleeder resistance of 10^6 – 10^9 ohms.

The following types are available, specifications in mm:

Art.-No.	Art.-No.	Short description	Type	Material	Total length	Weight in g
5-079	5-079-13	cutting tweezers	for oblique cutting, cutting width 10 mm, very stable	Carbon steel	115	25
5-879	5-879-13	cutting tweezers	for flush cutting, cutting width 10 mm, very stable	Carbon steel	115	25

NEW

STEEL



WITH ESD COATING

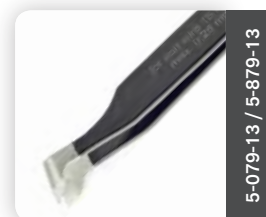

ESD AND ELECTRONICS
Tweezers

SELF-HOLDING TWEEZERS

Made from quality steel (nickel-plated, not anti-magnetic) or made from Stainless steel (anti-magnetic, non-corrosive and acid-resistant, non-reflective and matt-polished). Dissipative ESD coating available on request.

The following types are available, specifications in mm:

Art.-No.	Art.-No.	Short description	Type	Material	Total length	Weight in g
5-057	5-057-13	SMD cross tweezers, fine	self-holding, straight, very fine and delicate tip	stainless-steel	120	13
5-058	5-058-13	SMD cross tweezers, fine	self-holding, angled, very fine and delicate tip	stainless-steel	120	13
5-857	5-857-13	SMD cross tweezers, fine	self-holding, straight, strong and stable tip	stainless-steel	125	15
5-858	5-858-13	SMD cross tweezers, fine	self-holding, angled, strong and stable tip	stainless-steel	125	15
5-115		thermal tweezers	heat dissipative, non-serrated copper gripper jaws 5 x 11 mm	nickel-plated steel	165	35
5-155		cross tweezers	grripper jaws spoonful 5 mm, fine, serrated, non-slip	nickel-plated steel	160	35
5-155-1		cross tweezers, painted	grripper jaws spoonful 5 mm, fine, serrated, non-slip	antiallergical	160	40
5-156		soldering-cross tweezers	plastic handle, non-slip	nickel-plated steel	160	29
5-156-7		soldering-cross tweezers	plastic handle, non-slip	stainless-steel	160	29

NEW

NEW

NEW

NEW

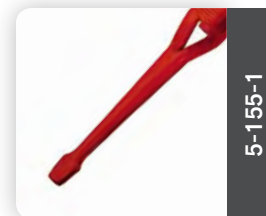
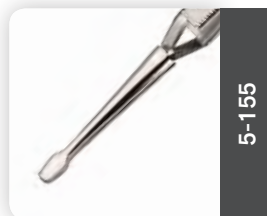
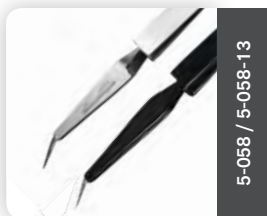
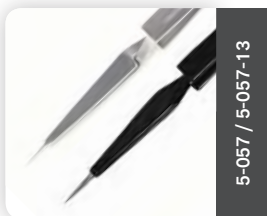
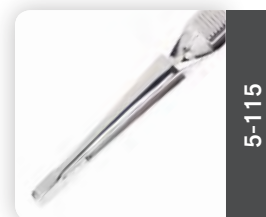
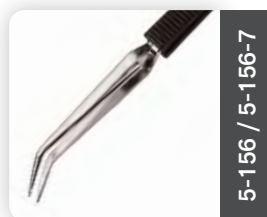
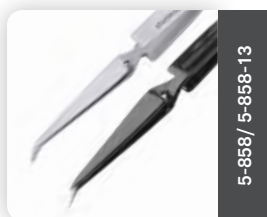
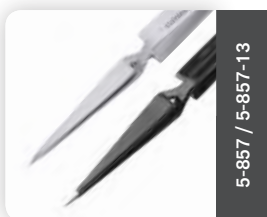

PLASTIC TWEEZERS

ESD tweezers made of conductive, black, glass fibre reinforced plastic material (Vestamid) which is antimagnetic, resistant to acids, usable at temperatures up to 175 °C and free of silicone and Armin.

The precisely matched tip closure allows components to be held optimally at a constant pressure.

Conductive between 10² and 10⁴ ohms.

The following types are available, specifications in mm:

Art.-No.	Short description	Type	Material	Total length	Weight in g
5-191	ESD plastic precision tweezers	tip 2 mm wide, deductive	PA	120	5
5-192	ESD plastic precision tweezers	tip 3 mm wide, deductive	PA	120	5
5-193	ESD plastic precision tweezers	tip 6mm wide, deductive	PA	120	5
5-194	ESD plastic precision tweezers	hook tip, deductive	PA	120	5
5-195	ESD plastic precision tweezers	very fine tip, deductive	PA	120	5
05-0030	plastic tweezers	serrated tip	PP	130	6



▶ 5-090 V

ESD plastic precision tweezers set VARIO 5 pcs

Content: 5-090-0 ESD tool holder VARIO 8 slotted holes

5-191, 5-192, 5-193, 5-194, 5-195

Weight: 530 g

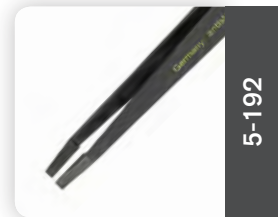
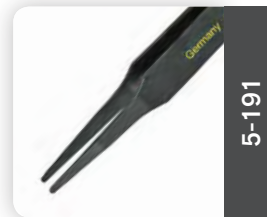

▶ 5-190 V

ESD plastic precision tweezers set VARIO pcs

Content: 5-090-0 ESD tool holder VARIO 8 slotted holes

5-191, 5-192, 5-193, 5-194, 5-195, 5-454

Weight: 390 g

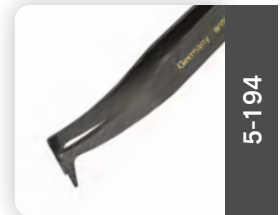

▶ 5-180

ESD plastics precision tweezers set 5 pcs

Content: 5-180-0 tweezers holder made of dissipative plastic

5-191, 5-192, 5-193, 5-194, 5-195

Weight: 200 g

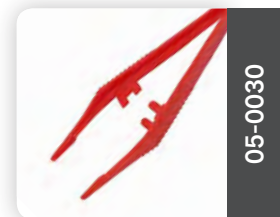
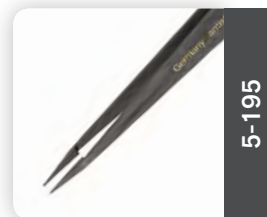

p. 36 VARIO-Holder



CHANGEABLE TIPS TWEEZERS

The body of the tweezers is made from anti-magnetic, non-corrosive and acid-resistant stainless steel – non-reflective and matt-polished

Carbofib tips

Carbon-fibre reinforced plastic, electrically conductive 10^2 – 10^3 ohms, scratch-proof, fully elastic, fatigue-resistant, vibration-dampening, water-repellent, resistant to most acids, alkalis and solvents.

The following types are available, specifications in mm:

Art.-No.	Short description	Type	Material	Total length	Weight in g
5-431	ESD tweezers with changeable tips	rounded tips 1.5 mm wide, conductive	stainless steel / Carbofib	125	17
5-431-0	ESD replacement tips for 5-431 (pair)	rounded tips 1.5 mm wide, conductive	Carbofib	42	2
5-432	ESD tweezers with changeable tips	angular tips 2 mm wide, conductive	stainless steel / Carbofib	125	17
5-432-0	ESD replacement tips for 5-432 (pair)	angular tips 2 mm wide, conductive	Carbofib	42	2
5-433	ESD tweezers with changeable tips	narrow blunt tip 1 mm wide, conductive	stainless steel / Carbofib	125	17
5-433-0	ESD replacement tips for 5-433 (pair)	narrow blunt tip 1 mm wide, conductive	Carbofib	42	2
5-434	ESD tweezers with changeable tips	very fine rounded tip 0.6 mm, conductive	stainless steel / Carbofib	125	17
5-434-0	ESD replacement tips for 5-434 (pair)	very fine rounded tip 0.6 mm, conductive	Carbofib	42	2

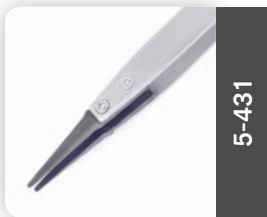

5-431

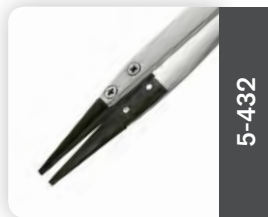

5-432

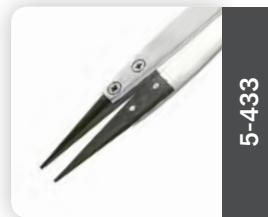

5-433

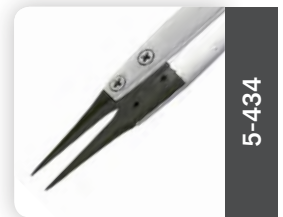

5-434

Delrin tips

Universal plastic, fully insulating for 10^{13} and 10^{15} ohms, excellent technical properties, low frictional resistance, good abrasion resistance, excellent spring power, high fatigue strength, high dielectric strength, low dielectric dissipation factor, good chemical resistance, particularly to solvents, very resistant to stress crack formation.

Ceramic tips

Conductive between 10^6 and 10^9 ohms, highly wear-resistant ceramic (zirconium), excellent mechanical and thermal properties, heat-resistant up to 800 °C, solder-repellent, coefficient of thermal expansion 10×10^{-6} K⁻¹, thermal conductivity 2 W/mK, resistant to acids and solvents.

The following types are available, specifications in mm:

Art.-No.	Short description	Type	Material	Total length	Weight in g
5-441	Delrin tweezers	rounded tips 1.5 mm wide, insulating	stainless steel / Delrin	125	17
5-441-0	Delrin replacement tips for 5-441 (pair)	rounded tips 1.5 mm wide, insulating	Delrin	42	2
5-443	Delrin tweezers	narrow blunt tips 1 mm wide, insulating	stainless steel / Delrin	125	17
5-443-0	Delrin replacement tips for 5-443 (pair)	narrow blunt tips 1 mm wide, insulating	Delrin	42	2
5-452	ESD ceramic tweezers	rounded tips 2 mm wide, insulating	stainless steel / Zirconia	125	17
5-452-0	ESD ceramic replacement tips for 5-452 (pair)	rounded tips, 2 mm wide, insulating	Zirconia	42	2
5-454	ESD ceramic tweezers	fine tips 0.7 mm wide, insulating	stainless steel / Zirconia	125	17
5-454-0	ESD ceramic replacement tips for 5-454 (pair)	fine tips 0.7 mm wide, insulating	Zirconia	42	2



5-441

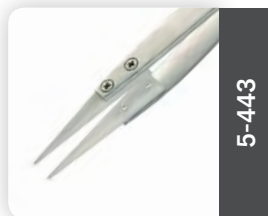

5-443



5-452

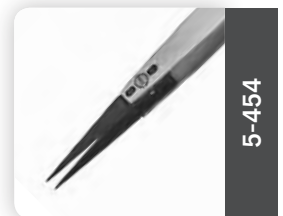

5-454

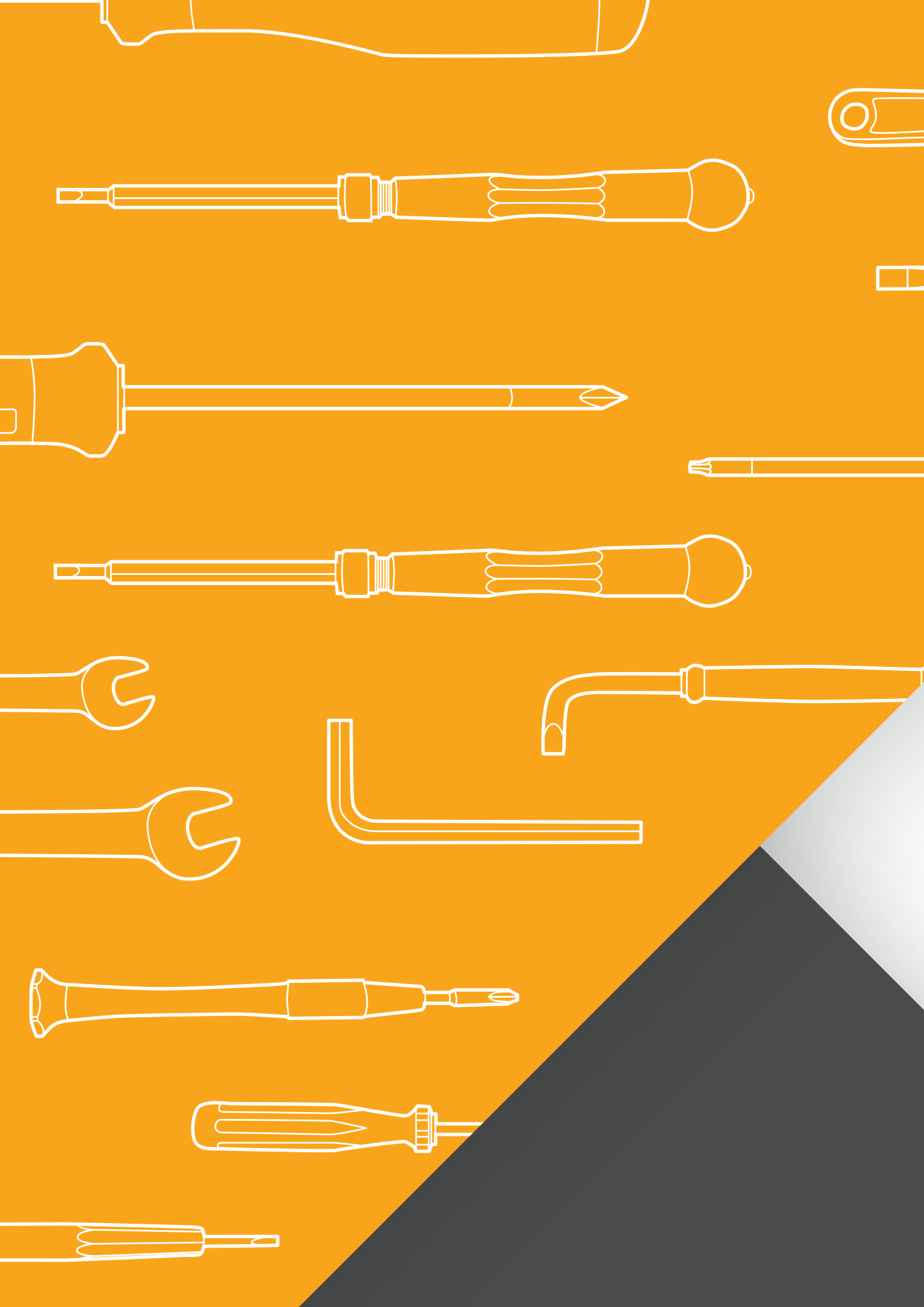



SCREW TOOLS – THE RIGHT BLADE FOR EVERY SCREW

ESD screwdrivers offer solutions for a wide range of screw heads, especially for applications in electronics. BERNSTEIN offers various bit sets and special screwdriving tools especially for the smallest dimensions.

ESD INTERCHANGEABLE SCREWDRIVER SETS

ESD interchangeable screwdrivers, single or in a set, in a practical roll-up case made of dissipative material (10^6-10^9 Ohm), equipped with double-sided screwdriver blades and an interchangeable ESD plastic handle. The holder is a brass clamping sleeve, suitable for all hexagon interchangeable blades with 4 mm wrench width. The blades are made of high-quality chrome vanadium steel, hardened over their entire length (HRC 56-58), matt chrome-plated, tip black burnished.

The following types are available, specifications in mm:



Art.-No.	Symbol	Size / drive	Blade length	Blade width	Blade thickness	Blade diameter	Handle length	Total length	Weight in g
4-901	Handle	—	—	—	—	—	85	105	16
4-905	⊖	Slot	120	1.5/3.0	0.4/0.6	4.5	—	120	12
4-906	⊖	Slot	120	2.0/3.5	0.4/0.6	4.5	—	120	12
4-907	⊖	Slot	120	2.5/4.0	0.6/0.9	4.5	—	120	12
4-911	⊕	PH00/PH000	120	2.0/1.5	0.8/0.76(-0.05)	4.5	—	120	12
4-912	⊕	PH0/PH1	120	3.0/4.5	0.84/1.3(-0.05)	4.5	—	120	12
4-919	★	T3/T4	120	1.12/1.30	M1.2-1.4/ M1.4-1.6	4.5	—	120	12
4-921	★	T5/T6	120	1.37/1.65	M1.6 - 2.0/M 2.0	4.5	—	120	12
4-922 L	★	T7/T8	120	1.97/2.30	M 2.5/M2.5	4.5	—	120	12
4-923 L	★	T9/T10	120	2.48/2.72	M3.0/ M3.0-3.5	4.5	—	120	12
4-932	⊗	TW0/FW0	120	—	0.45	4.5	—	120	12
4-933	⊗	TW1/FW1	120	—	0.57	4.5	—	120	12
4-934	⊗	TW2/FW2	120	—	0.75	4.5	—	120	12

► 4-920 ESD screwdriver set 9 pcs

Art.-No.	Content
4-960-0	ESD dissipative roll-up case 11 empty compartments
4-901	ESD interchangeable handle
4-905	⊖ Interchangeable blade slot 1.5/3.0mm
4-906	⊖ Interchangeable blade slot 2.0/3.5 mm
4-907	⊖ Interchangeable blade slot 2.5/4.0 mm
4-911	⊕ Interchangeable blade PH00/PH000
4-912	⊕ Interchangeable blade PH0/PH1
4-921	★ Interchangeable blade TORX T5/T6
4-922 L	★ Interchangeable blade TORX T7/T8
4-923 L	★ Interchangeable blade TORX T9/T10

► 4-960 ESD screwdriver set 12 pcs

Art.-No.	Content
4-960-0	ESD dissipative roll-up case 11 empty compartments
4-901	ESD interchangeable handle
4-905	⊖ Interchangeable blade slot 1.5/3.0mm
4-907	⊖ Interchangeable blade slot 2.5/4.0 mm
4-911	⊕ Interchangeable blade PH00/PH000
4-912	⊕ Interchangeable blade PH0/PH1
4-919	★ Interchangeable blade TORX T3/T4
4-921	★ Interchangeable blade TORX T5/T6
4-922 L	★ Interchangeable blade TORX T7/T8
4-923 L	★ Interchangeable blade TORX T9/T10
4-932	⊗ Interchangeable blade TW0/FW0
4-933	⊗ Interchangeable blade TW1/FW1
4-934	⊗ Interchangeable blade TW2/FW2



4-920



4-960

ESD SCREWDRIVERS

With slim, ergonomically shaped handles made of black dissipative plastic, surface resistance $10^6 - 10^9$ Ohm, standard: IEC 61340-5-1. The rotating centering head guarantees precision. The matt chrome-plated blade is made of high-quality chrome-molybdenum steel, hardened over its entire length (HRC 56 - 58).



The following types are available, specifications in mm:

Art.-No.	Symbol	Size / drive	Blade length	Blade width	Blade thickness	Blade diameter	Handle length	Total length	Weight in g
4-632		Slot	100	4	0.8	4.5	90	190	40
4-633		Slot	125	5.5	1	6	100	225	65
4-652		PH1	80	—	—	4.5	90	170	40
4-653		PH2	100	—	—	6	100	200	75

ESD ELECTRONIC SCREWDRIVERS

With slim, ergonomically shaped handles made of black dissipative plastic, surface resistance $10^6 - 10^9$ Ohm, standard: IEC 61340-5-1. The rotating centering head guarantees precision. The matt chrome-plated blade is made of high-quality chrome-molybdenum steel, hardened over its entire length (HRC 56 - 58).



The following types are available, specifications in mm:

Art.-No.	Symbol	Size / drive	Blade length	Blade width	Blade thickness	Blade diameter	Handle length	Total length	Weight in g
4-603		Slot	40	1.5	0.25	2	80	120	11
4-605		Slot	40	2	0.4	2	80	120	11
4-606		Slot	50	2.5	0.4	2.5	95	145	17
4-607		Slot	50	3	0.5	3	95	145	18
4-608		Slot	60	3.5	0.6	3.5	110	170	26
4-609		Slot	60	4	0.8	4	110	170	28
4-621		PH000	40	1.5	0.76 (-0.05)	2	80	120	10
4-622		PH00	40	2.0	0.8	2	80	120	11
4-623		PH0	50	3.0	0.84	3	95	145	18
6-657		T2	40	0.94	M 1.0 - 1.2	2.5	80	120	13
6-658		T3	40	1.12	M 1.2 - 1.4	2.5	80	120	13
6-659		T4	40	1.30	M 1.4 - 1.6	2.5	80	120	13
6-661		T5	40	1.37	M 1.6 - 2.0	2.5	80	120	13
6-662		T6	40	1.65	M 2.0	2.5	80	120	13
6-663 L		T7	50	1.97	M 2.5	3.5	95	145	13
6-664 L		T8	50	2.3	M 2.5 - 2.9	3.5	95	145	13
6-665 L		T9	50	2.48	M 3.0	4	110	160	19
6-666 L		T10	60	2.72	M 3.0 - 3.5	4	110	170	19



ESD ELECTRONIC SCREWDRIVER SETS



With slim, ergonomically shaped handles made of black dissipative plastic, surface resistance $10^6 - 10^9 \text{ Ohm}$
 Standard: IEC 61340-5-1. The rotating centering head guarantees precision. The matt chrome-plated blade is made of high-quality chrome-molybdenum steel, hardened over its entire length (HRC 56 - 58).

► 4-610

ESD screwdriver set 6 pcs

With practical plastic holder
 For hanging or setting up
 Weight: 111 g

Art.-No.	Content
4-603	 Slot blade 1.5 x 0.25 x 40 mm
4-605	 Slot blade 2.0 x 0.4 x 40 mm
4-606	 Slot blade 2.5 x 0.4 x 50 mm

Art.-No.	Content
4-607	 Slot blade 3.0 x 0.5 x 50 mm
4-608	 Slot blade 3.5 x 0.6 x 60 mm
4-609	 Slot blade 4.0 x 0.8 x 60 mm









4-610

► 4-620

ESD screwdriver set 6 pcs

With practical plastic holder
 For hanging or setting up
 Weight: 78 g

Art.-No.	Content
4-603	 Slot blade 1,5 x 0,25 x 40 mm
4-605	 Slot blade 2,0 x 0,4 x 40 mm
4-607	 Slot blade 3,0 x 0,5 x 50 mm

Art.-No.	Content
4-621	 Cross-recess PH000
4-622	 Cross-recess PH00
4-623	 Cross-recess PH0









4-620

► 6-610

ESD socket wrench set 6 pcs

With practical plastic holder
 For hanging or setting up
 Weight: 200 g

Art.-No.	Content
6-612	 Hex socket wrench 2.0 mm
6-614	 Hex socket wrench 3.0 mm
6-617	 Hex socket wrench 4.0 mm

Art.-No.	Content
6-618	 Hex socket wrench 4.5 mm
6-619	 Hex socket wrench 5.0 mm
6-621	 Hex socket wrench 5.5 mm









6-610

► 6-660

ESD TORX screwdriver set 6 pcs

With practical plastic holder
 For hanging or setting up
 Weight: 90 g

Art.-No.	Content
6-661	 TORX T5
6-662	 TORX T6
6-663 L	 TORX T7 with hole

Art.-No.	Content
6-664 L	 TORX T8 with hole
6-665 L	 TORX T9 with hole
6-666 L	 TORX T10 with hole



6-660

TOOL HOLDER VARIO

p. 36

VARIO holder

NEW



140 mm wide rail for hanging pliers and tweezers



8 slotted holes for inserting tools up to a diameter of 9 mm

Dimensions
(L x W x H): 140 x 150 x 75 mm
Weight: 400 g



PRIVATE LABEL

on request with logo print

Locking aids for a secure hold of the tools

Screw holes (Ø6mm) for mounting on the wall



5-090-2
VARIOinox

5-090-1
VARIOcrafts

NEW

NEW

Art.-No.	Content
5-090-0	VARIOtronics, dissipative (10 ⁶ - 10 ⁹ Ohm)
5-090-1	VARIOcrafts, dark grey metallic
5-090-2	VARIOinox, brushed stainless steel

Under the search term **VARIO** you will find all information about the tool holder and other sets on our website.

Available with dark grey powder coating or as brushed stainless steel.

ESD ELECTRONIC SCREWDRIVER SETS

With the ESD tool holder VARIO your tool is always at hand. Whether pliers, tweezers or screwdrivers - everything finds its place here!

The sturdy tool holder made of multi-bent 1 mm thick sheet steel was designed for several applications. On the upper edge, which is bordered by two stoppers on the left and right, tweezers and pliers can be hung securely and ready to hand. The 8 slot holes on the front of the stand are ideal for inserting our electronic screwdrivers.

Recesses on the back hold each screwdriver in optimal position.

The high quality black ESD-Coating has a bleeder resistance between $10^6 - 10^9$ Ohm and is thus ideally suited for working in EPA protected areas.

Two holes on the backside for space-saving wall mounting.

p. 41 ff [more VARIO sets](#)



► 4-610 VC

ESD screwdriver set VARIO 9 pcs

Weight: 590 g

Art.-No.	Content
5-090-0	ESD tool holder VARIO 8 slots
4-603	⊖ ESD screwdriver slot blade 1.5 x 0.25 x 40 mm
4-605	⊖ ESD screwdriver slot blade 2.0 x 0.4 x 40 mm
4-606	⊖ ESD screwdriver slot blade 2.5 x 0.4 x 50 mm
4-607	⊖ ESD screwdriver slot blade 3.0 x 0.5 x 50 mm
4-608	⊖ ESD screwdriver slot blade 3.5 x 0.6 x 60 mm
4-609	⊖ ESD screwdriver slot blade 4.0 x 0.8 x 60 mm
3-604-15	ESD side cutters CLASSICline flush 115mm
5-055-13	ESD SMD tweezers 120mm form 7a stainless steel angle 40° dissipative



4-610 VC

► 4-620 VC

ESD screwdriver set VARIO 9 pcs

Weight: 545 g

Art.-No.	Content
5-090-0	ESD tool holder VARIO 8 slots
4-603	⊖ ESD screwdriver slot blade 1.5 x 0.25 x 40 mm
4-605	⊖ ESD screwdriver slot blade 2.0 x 0.4 x 40 mm
4-607	⊖ ESD screwdriver slot blade 3.0 x 0.5 x 50 mm
4-621	⊕ ESD screwdriver cross-recess PH000
4-622	⊕ ESD screwdriver cross-recess PH00
4-623	⊕ ESD screwdriver cross-recess PH0
3-604-15	ESD side cutters CLASSICline flush 115mm
5-055-13	ESD SMD tweezers 120mm form 7a stainless steel angle 40° dissipative



4-620 VC



► 6-610 VC

ESD tool kit VARIO 9 pccs

Weight: 575 g

Art-No.	Content
5-090-0	ESD tool holder VARIO 8 slots
6-612	ESD hex socket wrench 2.0 mm
6-614	ESD hex socket wrench 3.0 mm
6-617	ESD hex socket wrench 4.0 mm
6-618	ESD hex socket wrench 4.5 mm
6-619	ESD hex socket wrench 5.0 mm
6-621	ESD hex socket wrench 5.5 mm
3-604-15	ESD side cutters CLASSICline flush 115mm
5-055-13	ESD SMD tweezers 120mm form 7a stainless steel angle 40° dissipative



6-610VC

► 6-660 VC

ESD tool kit VARIO 9 pcs

Weight: 555 g

Art-No.	Content
5-090-0	ESD tool holder VARIO 8 slots
6-661	ESD screwdriver TORX T5
6-662	ESD screwdriver TORX T6
6-663 L	ESD screwdriver TORX T7 with hole
6-664 L	ESD screwdriver TORX T8 with hole
6-665 L	ESD screwdriver TORX T9 with hole
6-666 L	ESD screwdriver TORX T10 with hole
3-604-15	ESD side cutters CLASSICline flush 115mm
5-055-13	ESD SMD tweezers 120mm form 7a stainless steel angle 40° dissipative



6-660 VC

SCREWDRIVERS POWERLINE



The chrome-plated blade is made of high-quality chrome vanadium steel and hardened over its entire length to prevent twisting (HRC 56 - 58). The tip is burnished for reasons of dimensional accuracy and to prevent chrome chipping. The ergonomically shaped multi-component handle is non-slip, impact-resistant and has a practical hanging hole for your workbench.

The quality is particularly evident in the manufacturing process of the blade. During quality testing, the blade is clamped in a torque test rig and twisted until it breaks smoothly. According to DIN, this has to be done in a very specific Newton metre range. Only a smooth fracture is safe! Low quality products can splinter or tear, which can be extremely dangerous.



The following types are available, specifications in mm:







Art.-No.	Symbol	Size / drive	Blade length	Blade width	Blade thickness	Blade diameter	Handle length	Total length	Weight in g
4-521		Slot	75	2.5	0.4	2.5	100	175	26
4-522		Slot	75	3	0.5	3	100	175	27
4-523		Slot	100	4	0.8	4	100	200	36
4-524		Slot	150	5	1	5.5	107	257	74
4-504		Slot	100	5.5	1	6	107	207	62
4-506		Slot	125	6.5	1.2	6	114	239	93
4-508		Slot	150	8	1.2	8	121	271	141
4-532		PH0	60	–	–	3	100	160	28
4-533		PH1	80	–	–	4.5	107	187	55
4-534		PH2	100	–	–	6	114	214	84
4-542		PZ0	60	–	–	3	100	160	28
4-543		PZ1	80	–	–	4.5	107	187	55
4-544		PZ2	100	–	–	6	114	214	90
6-979		T5	55	1.37	M 1.6 - 2.0	6	100	214	21
6-981		T6	65	1.65	M 2.0	3.5	100	165	29
6-983 L		T7	75	1.697	M 2.5	3.5	100	175	29
6-984 L		T9	75	2.48	M 3.0	4	100	175	29
6-985 L		T10	85	2.72	M 3.0 - 3.5	4	100	185	32
6-986 L		T15	85	3.26	M 3.5 - 4.0	4	100	185	34
6-987 L		T20	100	3.84	M 4.0 - 4.5	4	100	200	35
6-104		5	125	–	–	6	100	225	50
6-105		5.5	125	–	–	6	100	225	50
6-107		7	125	–	–	7	100	225	78

► 4-530

Screwdriver set POWERline 7pcs

In a display carton

Weight: 520 g

Art.-No.	Content
4-343 VDE	 VDE voltage tester slot blade 3.0 x 0.7 x 60 mm
4-504	 screwdriver POWERline slot blade 5.5 x 1.0 x 100 mm
4-506	 screwdriver POWERline slot blade 6.5 x 1.2 x 125 mm
4-523	 screwdriver POWERline slot blade 4.0 x 0.8 x 100 mm
4-524	 screwdriver POWERline slot blade 5.0 x 1.0 x 150 mm
4-533	 Screwdriver POWERline cross-recess PH1
4-534	 Screwdriver POWERline cross-recess PH2



4-530

SCREWDRIVER FOR SPECIAL REQUIREMENTS► **Screwdriver short**

Material chrome vanadium molybdenum steel HRC 56-58

2-component plastic handle ergonomically shaped, impact resistant



The following types are available, specifications in mm:



4-321



4-261

Art.-No.	Symbol	Size / drive	Blade length	Blade width	Blade thickness	Blade diameter	Handle length	Total length	Weight in g
4-321		Slot	25	4	0.8	4	55	80	30
4-261		PH1	25	—	—	4.5	55	80	30

► **Screwdriver for grub screws**

Material chrome vanadium molybdenum steel HRC 56-58, hard and stable plastic handle

The following types are available, specifications in mm:



4-311

Art.-No.	Symbol	Size / drive	Blade length	Blade width	Blade thickness	Blade diameter	Handle length	Total length	Weight in g
4-311		Slot	80	2.8	0.6	3	60	140	10

► **Liliput screwdriver**

Material chrome vanadium molybdenum steel, hard and stable plastic handle

The following types are available, specifications in mm:



4-301

Art.-No.	Symbol	Size / drive	Blade length	Blade width	Blade thickness	Blade diameter	Handle length	Total length	Weight in g
4-301		Slot	40	2.0	0.65	2	45	85	3

► 4-820

Liliput screwdriver set 60 pcs in holder

Material chrome vanadium molybdenum steel

Hard and stable plastic handle

Weight: 235 g

Content: 60 x Art.-No. 4-301



4-820

► 4-351

Offset screwdriver

Material chrome vanadium molybdenum steel HRC 56-58, hard and stable plastic handle

Slot blade, width: 4 mm, thickness: 0,65 mm, diameter: 4,5 mm

Weight: 12 g



4-351

WATCHMAKER SCREWDRIVERS

Our aluminium screwdrivers are available in three handle lengths, which are adapted to every drive size. The total lengths thus vary between 80 mm for the smallest and 115 mm for the largest screwdrivers.

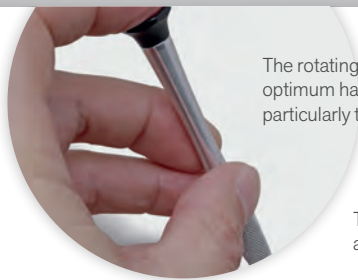

The rotating cap enables optimum handling for particularly tricky cases.



The knurling ensures a particularly good grip.

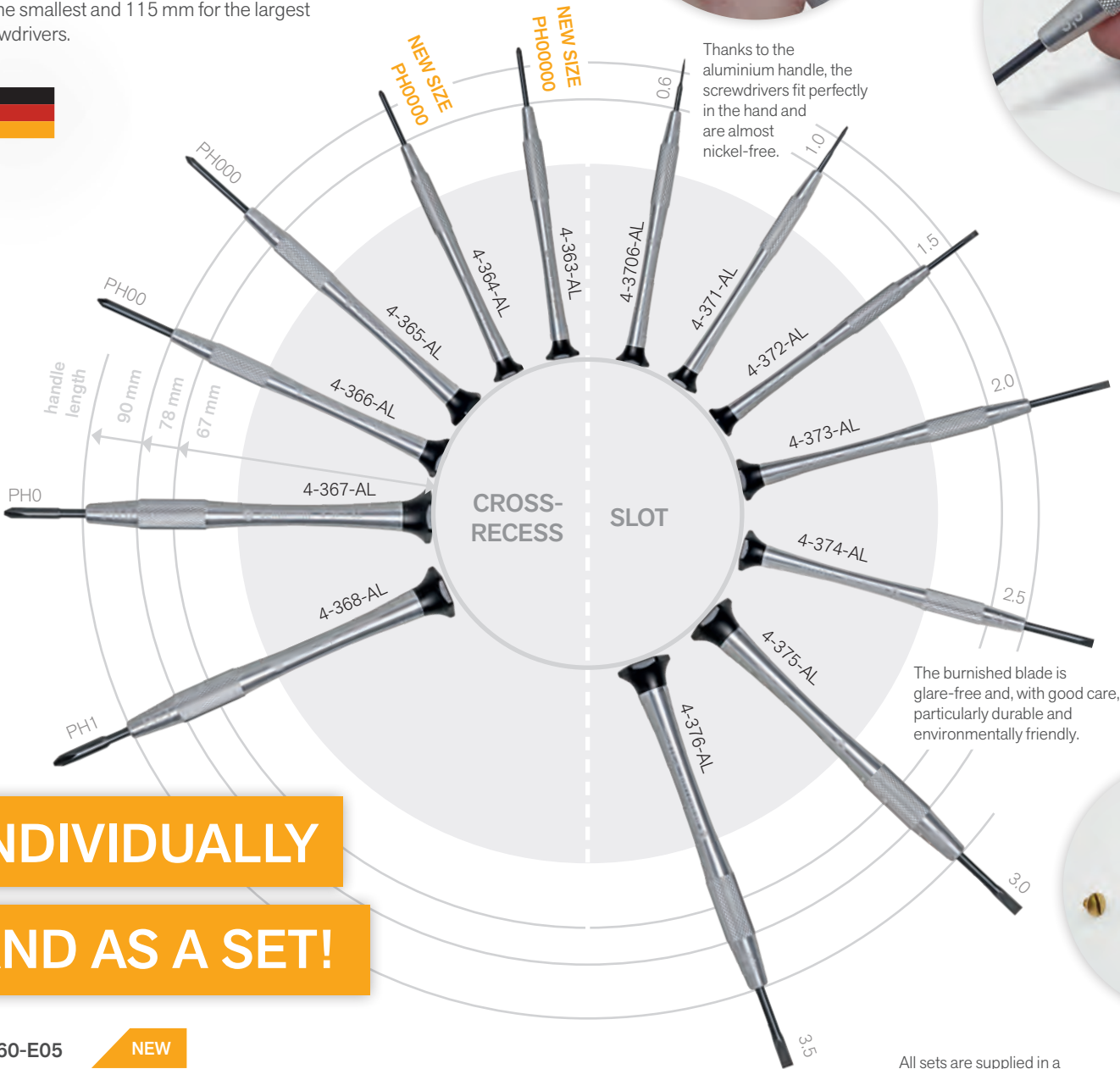

Thanks to the aluminium handle, the screwdrivers fit perfectly in the hand and are almost nickel-free.

The burnished blade is glare-free and, with good care, particularly durable and environmentally friendly.

**INDIVIDUALLY
AND AS A SET!**

► 4-360-E05 **NEW**

Watchmakers screwdriver set 7 pcs

In plastic case
Weight: 111 g

Art.-No.	Content
4-372-AL	⊖ Watchmaker screwdriver slot blade 1.5 x 0.23 x 16 mm
4-373-AL	⊖ Watchmaker screwdriver slot blade 2.0 x 0.4 x 22 mm
4-374-AL	⊖ Watchmaker screwdriver slot blade 2.5 x 0.4 x 22 mm
4-375-AL	⊖ Watchmaker screwdriver slot blade 3.0 x 0.5 x 22 mm
4-376-AL	⊖ Watchmaker screwdriver slot blade 3.5 x 0.6 x 22 mm
4-367-AL	⊕ Watchmaker screwdriver cross-recess PH0
4-368-AL	⊕ Watchmaker screwdriver cross-recess PH1

All sets are supplied in a handy plastic case.



WATCHMAKER SCREWDRIVERS

NEW

p. 86

Care advice

CROSS-RECESS



SLOT



The following types are available, specifications in mm:

Art.-No.	Symbol	Size / drive	Blade length	Blade width	Blade thickness	Blade diameter	Handle length	Total length	Weight in g
4-363-AL		PH00000	16	1.0	—	1.0	66	82	3
4-364-AL		PH0000	16	1.5	—	1.5	66	82	3
4-365-AL		PH000	22	2	—	2	78	100	5
4-366-AL		PH00	22	2.5	—	2.5	78	100	5
4-367-AL		PH0	22	3	—	3	90	112	9.5
4-368-AL		PH1	22	3.5	—	3.5	90	112	9.5
4-3706-AL		Slot	14	0.6	0.15	1.0	67	81	3
4-371-AL		Slot	14	1	0.2	1	67	81	3
4-372-AL		Slot	16	1.5	0.23	1.5	67	83	3
4-373-AL		Slot	22	2	0.4	2	78	100	5
4-374-AL		Slot	22	2.5	0.4	2.5	78	100	5.5
4-375-AL		Slot	22	3	0.5	2.5	90	112	9.5
4-376-AL		Slot	22	3.5	0.6	2.5	90	112	9.5

▶ 4-360-E01

NEW

Watchmakers screwdriver set 3pcs (slot)

In plastic case

Weight: 17 g

Art.-No.	Content
4-3706-AL	Watchmaker screwdriver slot blade 0.6 x 0.15 x 14 mm
4-371-AL	Watchmaker screwdriver slot blade 1.0 x 0.2 x 14 mm
4-372-AL	Watchmaker screwdriver slot blade 1.5 x 0.23 x 16 mm

▶ 4-360-E02

NEW

Watchmakers screwdriver set 3pcs (PH)

In plastic case

Weight: 22 g

Art.-No.	Content
4-364-AL	Watchmaker screwdriver cross-recess PH0000
4-365-AL	Watchmaker screwdriver cross-recess PH000
4-366-AL	Watchmaker screwdriver cross-recess PH00

▶ 4-360-E03

NEW

watchmakers screwdriver set 6pcs (slot)

In plastic case

Weight: 37 g

Art.-No.	Content
4-3706-AL	Watchmaker screwdriver slot blade 0.6 x 0.15 x 14 mm
4-371-AL	Watchmaker screwdriver slot blade 1.0 x 0.2 x 14 mm
4-372-AL	Watchmaker screwdriver slot blade 1.5 x 0.23 x 16 mm
4-373-AL	Watchmaker screwdriver slot blade 2.0 x 0.4 x 22 mm
4-374-AL	Watchmaker screwdriver slot blade 2.5 x 0.4 x 22 mm
4-375-AL	Watchmaker screwdriver slot blade 3.0 x 0.5 x 22 mm

▶ 4-360-E04

NEW

Watchmakers screwdriver set 6pcs

In plastic case

Weight: 30 g

Art.-No.	Content
4-3706-AL	Watchmaker screwdriver slot blade 0.6 x 0.15 x 14 mm
4-371-AL	Watchmaker screwdriver slot blade 1.0 x 0.2 x 14 mm
4-372-AL	Watchmaker screwdriver slot blade 1.5 x 0.23 x 16 mm
4-364-AL	Watchmaker screwdriver cross-recess PH0000
4-365-AL	Watchmaker screwdriver cross-recess PH000
4-366-AL	Watchmaker screwdriver cross-recess PH00

WATCHMAKER SCREWDRIVERS

The watch screwdriver is not only for the watchmaker one of the most important tools, but also in the electrical sector, for the model maker or in the hobby and hobby supplies. The precision screwdriver with rotating cap facilitates precise repeated screwing, turning, tightening or loosening due to its special ease of movement.





▶ Watchmaker screwdrivers

Blades: material chrome-vanadium-molybdenum steel HRC 56-58, burnished
 Plastic handle with rotating cap ergonomically shaped with colour ring recognition.

Care advice: High humidity or touching the blades with your fingers (sweat) will cause a rust film.

Therefore, the blades should always be kept dry or rubbed with oil if stored for a longer period of time. If a rust film still forms on the blade, it can easily be removed with a light sharpening.

The following types are available, specifications in mm:





Art.-No.	Symbol	Size / drive	Blade length	Blade width	Blade thickness	Blade diameter	Handle length	Total length	Weight in g
4-381		Slot	18	1	0.45	2	86	104	3
4-382		Slot	18	1.4	0.45	2	86	104	5
4-383		Slot	18	1.8	0.45	2	86	104	5
4-384		Slot	18	2.3	0.6	2.5	86	104	6
4-385		Slot	18	3	0.6	2.5	86	104	6

▶ 4-380

Watchmaker screwdriver set 6 pcs (slot)

In plastic box

Weight: 64 g

Art.-No.	Content
4-381	 Watchmaker screwdriver slot blade 1.0 x 0.45 x 18 mm
4-382	 Watchmaker screwdriver slot blade 1.4 x 0.45 x 18 mm
4-383	 Watchmaker screwdriver slot blade 1.8 x 0.45 x 18 mm
4-384	 Watchmaker screwdriver slot blade 2.3 x 0.6 x 18 mm
4-385	 Watchmaker screwdriver slot blade 3.0 x 0.6 x 18 mm



4-380





▶ 4-392

Watchmaker screwdriver magazine 6 pcs

Material tool steel HRC 58-61

Metal handle with rotating cap (nickel-plated), for opening with internal blades

Weight: 33 g

Content
 Slot blade 1.5 mm
 Slot blade 2.0 mm
 Slot blade 2.5 mm
 Slot blade 3.0 mm
 Cross-recess PH0
Metal handle with rotating cap





▶ 4-393

Watchmaker screwdriver magazine 6 pcs

Material tool steel HRC 58-61

Metal handle with rotating cap (nickel-plated), for opening with internal blades

Weight: 32 g

Content
 Slot blade 1.5 mm
 Slot blade 2.0 mm
 Slot blade 2.5 mm
 Cross-recess PH00
 Cross-recess PH000
Metal handle with rotating cap



4-392, 4-393

WRENCH KEYS

► Hex wrench keys (VE10)

Material tool steel, surface nickel-plated
DIN ISO 2936 (DIN 911)

The following types are available, specifications in mm:

Art.-No.	Symbol	WAF inch	WAF	Leg length A	Leg length B	Weight in g
6-811	⬢	—	0.9	32	10	0.2
6-812	⬢	—	1.0	32	10	0.2
6-813	⬢	—	1.5	45	14	1
6-814	⬢	5/64	2.0	50	16	2
6-815	⬢	—	2.5	56	18	3
6-816	⬢	—	3.0	63	20	5
6-817	⬢	9/64	3.5	66	22	8
6-818	⬢	5/32	4.0	70	25	10
6-819	⬢	—	4.5	75	26	15
6-821	⬢	—	5.0	80	28	18
6-822	⬢	7/32	5.5	85	30	24
6-823	⬢	—	6.0	90	32	30
6-825	⬢	9/32	7.0	95	34	43
6-826	⬢	5/16	8.0	100	36	60
6-827	⬢	11/32	9.0	105	38	80
6-828	⬢	—	10.0	112	40	103
6-851	⬢	3/64	1.2	40	12	0.4
6-852	⬢	1/16	1.59	45	14	1
6-853	⬢	5/64	2.0	50	16	2
6-854	⬢	3/32	2.38	56	18	3
6-855	⬢	1/8	3.18	63	20	5
6-856	⬢	9/64	3.5	66	22	8
6-857	⬢	5/32	4.0	70	25	10
6-858	⬢	3/16	4.76	80	28	18
6-859	⬢	7/32	5.5	85	30	24
6-861	⬢	1/4	6.35	90	32	30
6-862	⬢	9/32	7.0	95	34	43
6-863	⬢	5/16	8.0	100	36	60
6-864	⬢	11/32	9.0	105	38	80
6-865	⬢	3/8	9.53	112	40	103

► 6-820

Wrench key set 8 pcs

Material tool steel, blade matt chromed, in plastic pocket
Content: 1.5 - 2.0 - 2.5 - 3.0 - 4.0 - 5.0 - 5.5 - 6.0 mm
Weight: 90 g

► 6-950

Ballpoint wrench key set 9 pcs

Material tool steel, blade matt chromed, in plastic holder
Content: 1.5 - 2.0 - 2.5 - 3.0 - 4.0 - 5.0 - 6.0 - 8.0 - 10.0 mm
Weight: 200 g

► 6-995

TORX wrench key set with hole 8 pcs

Material tool steel, burnished, in plastic pocket
Content: TORX T9 - T10 - T15 - T20 - T25 - T27 - T30 - T40 with hole
Weight: 120 g

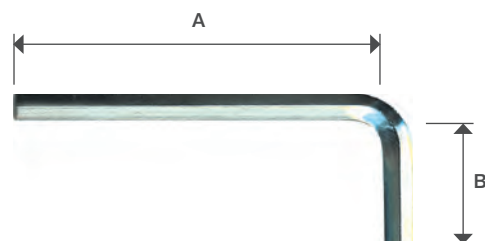

6-820



6-950



6-995

SOCKET WRENCHES

► 4-775

Plastic spring handle 6.0 mm

Material transparent plastic
Weight: 30 g



4-775

► **Socket wrench**

Material chrome vanadium molybdenum steel HRC 56-58, nickel-plated
Interchangeable blades for spring handle Art.-No. 4-775



The following types are available, specifications in mm:

Art.-Nro	Symbol	Size / drive	Blade length	Blade diameter	Total length	Weight in g
6-201	⊙	4	140	6	140	30
6-202	⊙	5.5	140	6	140	35
6-203	⊙	6	140	6	140	35
6-204	⊙	7	140	6	140	40
6-205	⊙	8	140	6	140	40
6-206	⊙	9	140	6	140	43
6-207	⊙	10	140	6	140	45

► 6-200

Socket wrench set 8 pcs

In plastic roll-up bag
Weight: 310 g

Art.-No.	Content
6-201	⊙ Socket wrench 4.0 mm without handle (set 6-200)
6-202	⊙ Socket wrench 5.5 mm without handle (set 6-200)
6-203	⊙ Socket wrench 6.0 mm without handle (set 6-200)
6-204	⊙ Socket wrench 7.0 mm without handle (set 6-200)
6-205	⊙ Socket wrench 8.0 mm without handle (set 6-200)
6-206	⊙ Socket wrench 9.0 mm without handle (set 6-200)
6-207	⊙ Socket wrench 10.0 mm without handle (set 6-200)
4-775	Plastic spring handle 6.0 mm



6-200

► 6-320

Socket wrench set 36 pcs with ratchet + extension

Content:
Sheet steel case with foam inlay
1/4 inch hex sockets 4.0 - 4.5 - 5.0 - 5.5 - 6.0 - 6.5 - 7.0 - 8.0 - 9.0 - 10 - 11 - 12 - 13
1/4 inch PH screwdriver PH1 - PH2
1/4 inch screwdriver 4.0 - 4.5
1/4 inch Allen key 3.0 - 4.0 - 5.0 - 6.0
1/4 inch TX screwdriver TX20 - TX25 - TX27 - TX30
1/4 inch cardan joint
1/4 inch extension 50 and 100 mm
1/4 inch handle with slide
1/4 inch plug-in handle with square drive
1/4 inch lever ratchet 72 teeth 140 mm
Allen wrench 1.25 - 1.5 - 2.0 - 2.5 - 3.0

Weight: 1320 g



6-320

OPEN-END WRENCHES AND RING SPANNERS

▶ **6-500** **NEW**

Double open-end wrench set 8 pcs

Material tool steel, surface chrome-plated, polished heads, DIN 3110
Content: 6 x 7 - 8 x 9 - 10 x 11 - 12 x 13 - 14 x 15 - 16 x 17 - 18 x 19 - 20 - 22 mm
Weight: 700 g



6-500

▶ **6-600** **NEW**

Combination wrench set 12 pcs

Material tool steel, surface chrome-plated, polished heads, DIN 3113
Content: 6 - 7 - 8 - 9 - 10 - 11 - 12 - 13 - 14 - 17 - 19 - 22 mm
Weight: 850 g



6-600

▶ **6-750**

Special double open-end wrench set 6 pcs

Material tool steel, surface nickel-plated, in roll-up bag
Content: 3 - 3.5 - 4 - 4.5 - 5 - 5.5 - 6 - 6.5 - 7 - 8 - 9 - 10 mm
Weight: 100 g

Also available on request with ESD coating (10⁶-10⁹ Ohm)



6-750

▶ **Adjustable spanners / adjustable wrenches**

Material chrome vanadium molybdenum steel HRC 56-58, surface nickel-plated

Art.-No.	Span width	Jaw length	Total length	Weight in g
6-771	0 - 13	12	100	55
6-772	0 - 19	22	150	135



6-772



ADJUSTMENT TOOLS AND TRIMMER ADJUSTMENT IN ELECTRONICS

A large number of electrical and electronic devices or assemblies need to be adjusted and set after the production process. Even when servicing, when fitting new components or when electrical values have altered due to age, adjustment is usually necessary to restore the optimum functioning of the device. In order to save costs and achieve a high degree of reliability, adjustment work should be reduced to a minimum on the basis of design and technological procedures.

BERNSTEIN manufactures a high-quality, fully insulating synthetic material for adjustment screwdrivers and keys that is tough and elastic. A material made of hard special plastic is also available to meet the highest demands in terms of torsional strength. BERNSTEIN supplies

adjustment screwdrivers and keys with inserts made from resilient hard bronze for cores which are especially difficult to remove. This material has a precise size accuracy even in the smallest dimensions. Because it is only processed as small cutting tips together with the plastic materials, interference by the resilient bronze is virtually eliminated.

BERNSTEIN manufactures a variety of high-grade ceramic tips and tweezers with ceramic tips for industrial adjustments and work on electrostatically sensitive components.

PLASTIC ADJUSTMENT SCREWDRIVERS

► Adjustment tools made of plastic

BERNSTEIN manufactures a high-quality, fully insulating synthetic material for adjustment screwdrivers and adjusting keys that is tough and yet elastic. A material made of hard special plastic is also available to meet the highest demands in terms of torsional strength. (Art.-No. 1-738 and 1-739).



The following types are available, specifications in mm:

Art.-No.	Symbol	Blade length	Blade width	Blade thickness	Blade diameter	Handle length	Total length	Weight in g
1-151	⊖	40	3	0.5	3	45	85	3
1-152	⊖	40	4	0.5	4	45	85	3
1-153	⊖	130	2	0.7	3	45	175	4
1-154	⊖	130	3	0.7	4	45	175	5
1-155	⊖	130	3.5	0.7	5	45	175	6
1-156	⊖	130	4	0.7	5	45	175	6
1-157	⊖	155	3	0.7	4	45	200	6

► 1-150

Plastic adjustment screwdriver set 7 pcs

Weight: 750 g

Art.-No.	Content
1-150-0	ESD case empty
1-151	⊖ Plastic adjusting screwdriver slot blade 3 x 0.5 x 40 mm
1-152	⊖ Plastic adjusting screwdriver slot blade 4 x 0.5 x 40 mm
1-153	⊖ Plastic adjusting screwdriver slot blade 2 x 0.7 x 130 mm
1-154	⊖ Plastic adjusting screwdriver slot blade 3 x 0.7 x 130 mm
1-155	⊖ Plastic adjusting screwdriver slot blade 3.5 x 0.7 x 130 mm
1-156	⊖ Plastic adjusting screwdriver slot blade 4 x 0.7 x 130 mm
1-157	⊖ Plastic adjusting screwdriver slot blade 3 x 0.7 x 155 mm



1-150

ADJUSTMENT SCREWDRIVERS WITH BRONZE INSERT

► Adjustment tools with bronze insert

BERNSTEIN supplies adjustment screwdrivers and keys with inserts made from resilient hard bronze for cores which are especially difficult to remove. This material has a very precise size accuracy even in the smallest dimensions. Because it is only processed as small cutting tips together with the plastic materials, interference by the resilient bronze is virtually eliminated.



The following types are available, specifications in mm:

Art.-No.	Symbol	Blade length	Blade width	Blade thickness	Blade diameter	Handle length	Total length	Weight in g
1-301	⊖	155	1.4	0.5	2.7	45	200	4
1-302	⊖	155	2	0.5	2.7	45	200	4
1-303	⊖	155	2.5	0.5	2.7	45	200	4
1-304	⊖	155	1.7	0.7	2.7	45	200	4
1-305	⊖	80	1.1	0.5	2.4	45	125	4
1-306	⊖	80	1.7	0.7	2.4	45	125	4
1-307	⊖	80	2	0.5	2.4	45	125	4

► 1-300

Bronze adjustment screwdriver set 7 pcs

Weight: 500 g

Art.-No.	Content
1-150-0	ESD case empty
1-301	⊖ Bronze adjusting screwdriver slot blade 1.4 x 0.5 x 155 mm
1-302	⊖ Bronze adjusting screwdriver slot blade 2 x 0.5 x 155 mm
1-303	⊖ Bronze adjusting screwdriver slot blade 2.5 x 0.5 x 155 mm
1-304	⊖ Bronze adjusting screwdriver slot blade 1.7 x 0.7 x 155 mm
1-305	⊖ Bronze adjusting screwdriver slot blade 1.1 x 0.5 x 80 mm
1-306	⊖ Bronze adjusting screwdriver slot blade 1.7 x 0.7 x 80 mm
1-307	⊖ Bronze adjusting screwdriver slot blade 2 x 0.5 x 80 mm



1-300

ADJUSTMENT SCREWDRIVER WITH GUIDE SLEEVE

► 2-145

Screwdriver with guide sleeve

Potentiometers or potentiometer (short Poti), is an electrical resistance component. By turning or shifting, the resistance value changes. It has three connections and is mainly used as a continuously adjustable voltage divider.

Screwdriver with guide sleeve for easy and safe adjustment of spindle resistances and potentiometers, with slot axis up to Ø 3.2 mm, blade width 2.8 mm, blade length 80 mm.

Total length: 140mm

Weight: 12 g



2-145

ADJUSTMENT SCREWDRIVERS MADE OF ZIRCONIA/CERAMIC

► Adjustment tools for ESD areas.

Ceramic bits meets the highest demands due to their excellent mechanical and thermal properties. The zirconium oxide material's hardness and breaking strength enables the manufacture and use of even the smallest dimensions with the highest possible resistance to wear. In addition to standard blades, we also manufacture special shapes at the customer's request.

► Ceramic – the long-lasting material

Zirconium oxide is a highly wear-resistant ceramic (zirconium), tetragonal ZrO₂, Y₂O₃ and partially stabilised. Physical properties at room temperature: Flexural strength 800 N/mm², elastic modulus 2x10⁵ N/mm² Density 6.05 g/cm³, hardness 1350HV, field of application up to 800 °C, coefficient of thermal expansion 10 x 10⁻⁶ K⁻¹ Thermal conductivity 2 W/mK, insulating electrical resistance.

► Ceramic adjustment screwdriver

ESD handle with rotating cap
Dissipative between 10⁶ and 10⁹ ohm
Total length: 100 mm, weight: 10 g



The following types are available, specifications in mm:

Art.-No.	Symbol	Size / drive	Blade length	Blade width	Blade thickness	Blade diameter	Handle length	Total length	Weight in g
1-851	⊖	–	20	0.9	0.3	3	80	100	10
1-852	⊖	–	20	1.3	0.3	3	80	100	10
1-853	⊖	–	20	1.5	0.3	3	80	100	10
1-854	⊖	–	20	1.8	0.3	3	80	100	10
1-855	⊖	–	20	1.95	0.35	3	80	100	10
1-856	⊖	–	20	2.5	0.7	3	80	100	10
1-857	⊖	–	20	3	0.3	3	80	100	10
1-858	⊖	–	20	3	0.7	3	80	100	10
1-861	⬢	1,95	20	–	–	3	80	100	10
1-862	⬢	2,45	20	–	–	3	80	100	10
1-865	⊕	PH00	20	–	–	3	80	100	10
1-866	⊕	PH0	20	–	–	3	80	100	10
1-867	⊕	–	20	2.4	0.8	3	80	100	10



1-750

HANDLES FOR CERAMIC ADJUSTMENT BITS

► 1-725

Adjustment screwdriver handle 80 mm plastic

Synthetic material, insulating, extra hard, sturdy
 Plastic handle with rotating cap for blades Ø 3 mm
 Total length: 80 mm, weight: 5 g



1-725

► 1-735

Adjustment screwdriver handle double-sided 100 mm plastic

Synthetic material, insulating, extra hard
 Plastic handle with rotating cap for blades Ø 3 mm, usable on both sides
 Total length: 100 mm, weight: 6 g



1-735

► Ceramic adjustment bits for insertion

Bits for Art.-No. 1-725 and 1-735

The following types are available, specifications in mm:



Art.-No.	Symbol	Size / drive	Blade length	Blade width	Blade thickness	Blade diameter	Handle length	Total length	Weight in g
HARD PLASTIC									
1-738		–	32	1.5	0.5	3	–	32	1
1-739		–	32	3	0.5	3	–	32	1
CERAMIC (zirconia)									
1-751		–	32	0.9	0.3	3	–	32	1
1-752		–	32	1.3	0.3	3	–	32	1
1-753		–	32	1.5	0.3	3	–	32	1
1-754		–	32	1.8	0.3	3	–	32	1
1-755		–	32	1.95	0.35	3	–	32	1
1-756		–	32	2.5	0.7	3	–	32	1
1-757		–	32	3	0.3	3	–	32	1
1-758		–	32	3	0.7	3	–	32	1
1-761		1.95	32	–	–	3	–	32	1
1-762		2.45	32	–	–	3	–	32	1
1-763		2.6	32	–	–	3	–	32	1
1-764		PH000	32	–	–	3	–	32	1
1-765		PH00	32	–	–	3	–	32	1
1-766		PH0	32	–	–	3	–	32	1
1-767		–	32	2.4	0.8	3	–	32	1

► 1-750

Ceramic adjusting screwdriver set 13 pcs

In plastic case, weight: 750 g

Art.-No.	Content	Art.-No.	Content
1-750-0	Hinged lid box empty	1-761	Ceramic blade (Bit) hex blade 1.95 x 32 mm
1-735	Adjustment screwdriver handle double-sided 100 mm plastic	1-762	Ceramic blade (Bit) hex blade 2.45 x 32 mm
1-751	Ceramic blade (Bit) slot blade 0.9 x 0.3 x 32 mm	1-765	Ceramic blade (Bit) cross-recess PH00
1-752	Ceramic blade (Bit) slot blade 1.3 x 0.3 x 32 mm	1-766	Ceramic blade (Bit) cross-recess PH0
1-753	Ceramic blade (Bit) slot blade 1.5 x 0.3 x 32 mm	1-767	Ceramic blade (Bit) Cross 2.4 x 0.8 mm
1-754	Ceramic blade (Bit) slot blade 1.8 x 0.3 x 32 mm		
1-755	Ceramic blade (Bit) slot blade 1.95 x 0.35 x 32 mm		
1-756	Ceramic blade (Bit) slot blade 2.5 x 0.7 x 32 mm		
1-757	Ceramic blade (Bit) slot blade 3 x 0.3 x 32 mm		

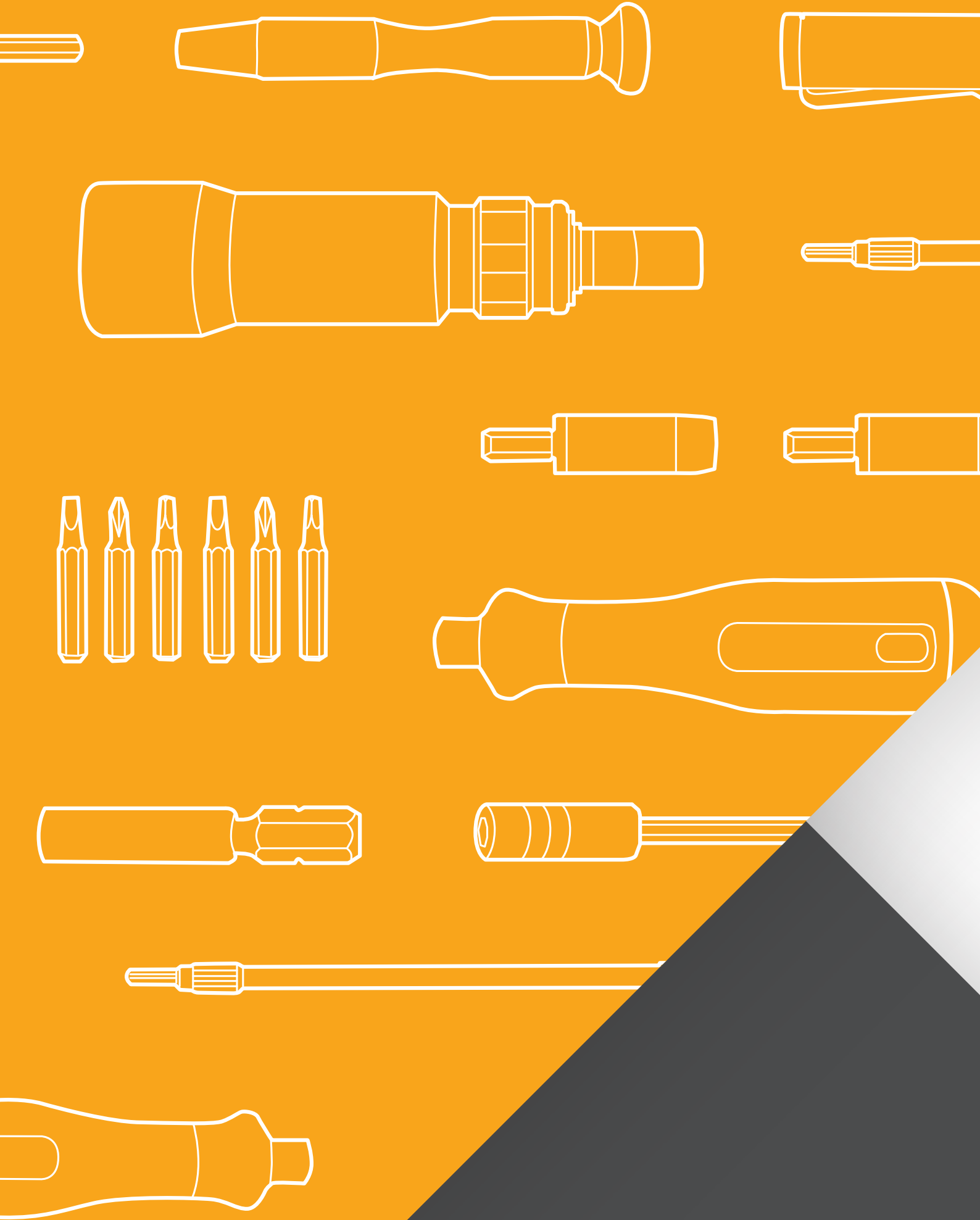

NEW

TORQUE TOOLS - FOR EACH MOMENT THE RIGHT TURN!

The demands placed on screw connections are rising. This also increasingly applies to connections with low preload forces as screws tend to be overtightened. This can result in major damage. That's why it makes sense to tighten screws with a well-defined torque.

Tools that allow their tightening torque to be limited should be used for the quality assurance stage during production assembly and for the repair of electronic components.

For this reason we developed a torque screwdriver and a series of torque adapters for easy operation in the electronics sector.

By using the right tool and the correct torque settings, you can fasten screw connections that will fulfil your purposes in the long term, sparing you costly and time-consuming thread repairs.

NEW

TORQUE – ONE SYSTEM, MANY APPLICATIONS!

The new TORQUEline from BERNSTEIN impresses with its flexibility. We have developed a tooling system that allows to combine the individual components in different ways. Thus, you have the matching torque for every application.

Thanks to the adapter, every bit holder is turned into a professional torque screwdriver

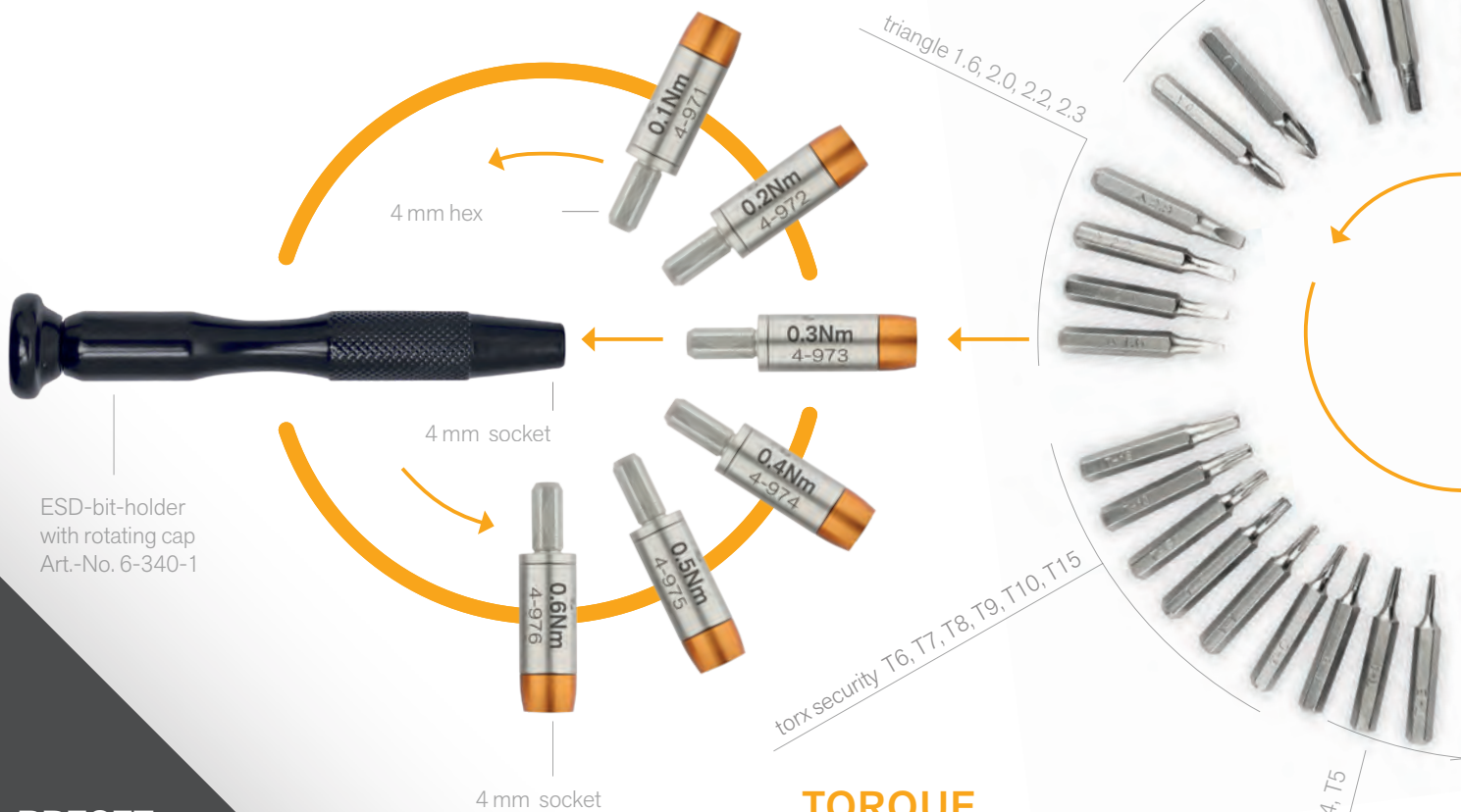

42 X 4 MM BITS

ESD-bit-holder with rotating cap Art.-No. 6-340-1

PRESET

torque
0.1 Nm - 0.6 Nm and
0.6 Nm - 3.0 Nm



TORQUE ADAPTER

The torque adapter is suitable for particularly delicate applications. Thanks to the bit adapter, it can be easily clamped between any commercially available holding tool and a 4 mm bit. This turns every bit screwdriver into a torque screwdriver. When the factory-set torque is reached, you will hear a loud click. Now the torque no longer increases. The screw is now tightened to the correct torque. The adapter is made of tool steel, has a hardness of 43 - 46 HRC and a magnet in the bit holder. The torque adapter can also be used to loosen the screws, because it has no torque limit when turning back.

- ▶ 20.000 CLICKS
- ▶ ±10 % NM-TOLERANCE

TORQUE SCREWDRIVER

The torque screwdriver has been developed to carry out the screwdriving process accurately and reproducibly with the correct tightening torque. The torque (0.05 to 0.6 Nm) of the torque screwdriver can be selected and adjusted. It has a hex bit intake 6.3 mm (1/4") with a clamping ball.

The torque can be adjusted to the desired size and locked with a knurled screw. The screwdriver has a total length of 105 mm. Useful accessories are the extension (110 mm) art. no. 6-340-2 and a bit adapter from 6.3 mm to 4 mm bits..

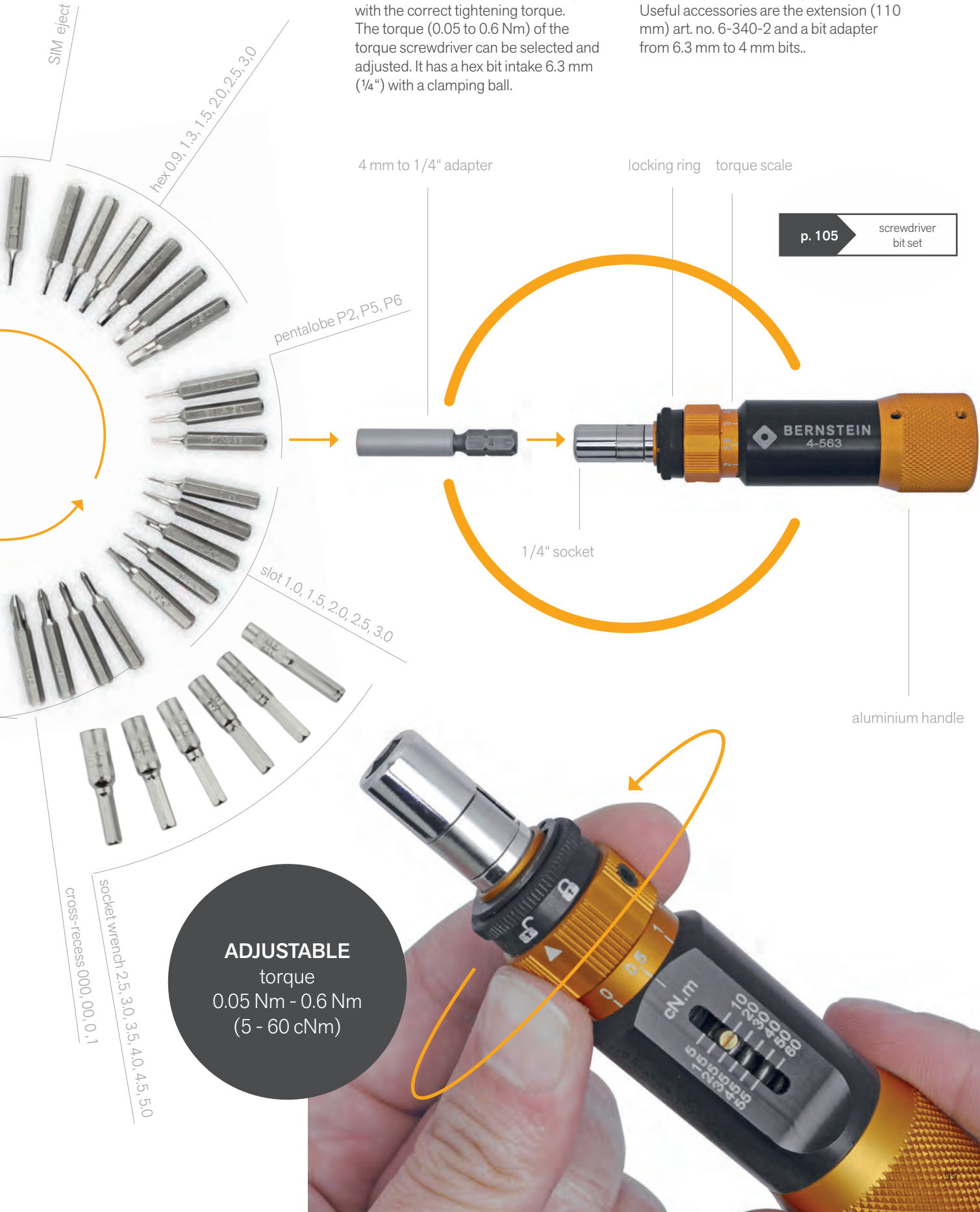

ADJUSTABLE
torque
0.05 Nm - 0.6 Nm
(5 - 60 cNm)

TORQUE SCREWDRIVERS, ADAPTERS AND BITS

NEW

► 4-563

Mini torque screwdriver 0.05 - 0.6 Nm with adapter

With multicoloured knurled aluminium handle, hex socket 6.35 mm (1/4 inch), adjustable torque from 0.05 to 0.6 Nm tolerance: ± 6 %

With adapter from 6.3 mm to 4 mm bits. Blade length 15 mm, blade Ø 10 mm

Material high-quality tool steel

Total length: 100 mm

Weight: 111 g



► Torque adapter for 4 mm bits

Torque adapter length 22 mm (without shank),

Adapter Ø 8 mm, hex socket 4.0 mm, (5/32 inch)

Material stainless steel and quality tool steel

Tolerance: ± 10 %

Weight: 3 g



The following types are available, specifications in mm:

Art.-No.	Description	NM	Kgcm	in-lb	size/ shank	Blade length	Blade diameter	Total length	Weight in g
4-971	Torque adapter for 4 mm bits	0.1	1.0	0.9	4	10	8	32	7.5
4-972	Torque adapter for 4 mm bits	0.2	2.0	1.8	4	10	8	32	7.5
4-973	Torque adapter for 4 mm bits	0.3	3.1	2.7	4	10	8	32	7.5
4-974	Torque adapter for 4 mm bits	0.4	4.1	3.5	4	10	8	32	7.5
4-975	Torque adapter for 4 mm bits	0.5	5.1	4.4	4	10	8	32	7.5
4-976	Torque adapter for 4 mm bits	0.6	6.1	5.3	4	10	8	32	7.5

► Torque adapter for 1/4" bits

Torque adapter length 39 mm (without shank),

Adapter Ø 12 mm, hex socket 6.35 mm (1/4 inch),

Material stainless steel and quality tool steel

Tolerance: ± 10 %

Weight: 3 g



The following types are available, specifications in mm:

Art.-No.	Description	NM	Kgcm	in-lb	Colour code	size/ shank	Blade length	Blade diameter	Total length	Weight in g
4-981	Torque adapter for 1/4" bits	0.6	6.1	5.3	red	6.35	10	12	39	26
4-982	Torque adapter for 1/4" bits	0.9	9.2	8.0	grey	6.35	10	12	39	26
4-983	Torque adapter for 1/4" bits	1.2	12.0	10.6	green	6.35	10	12	39	26
4-984	Torque adapter for 1/4" bits	1.4	14.0	12.4	orange	6.35	10	12	39	26
4-985	Torque adapter for 1/4" bits	2.0	20.0	17.7	purple	6.35	10	12	39	26
4-986	Torque adapter for 1/4" bits	3.0	30.6	26.6	blue	6.35	10	12	39	26

BIT ADAPTERS, HANDLES AND BITS

NEW

▶ 4-106

Screwdriver handle with 5/32 inch magnetic bit holder

2-component synthetic handle, ergonomically shaped, non-slip, blades Ø 7.5 mm,
Socket WAF 4 mm, material high-quality tool steel
Total length: 110 mm
Weight: 38 g



▶ 4-107

Screwdriver handle with 1/4 inch magnetic bit holder

2-component synthetic handle, ergonomically shaped, non-slip, blades Ø 10.0 mm,
Socket WAF 6.35 mm, material high-quality tool steel
Total length: 120 mm
Weight: 58 g



▶ 6-340-1

Bit holder for 4 mm hex bits, with ESD coating

Ergonomically shaped handle, material aluminium, ESD powder coated
Surface resistance 10⁶ - 10⁹ Ohm, Norm: IEC 61340-5-1
Total length: 80 mm
Weight: 15 g



▶ 4-564

Bit adapter 1/4 inch > 4 mm bit

Blade length 28 mm, blades Ø 8 mm, material steel/aluminium
Total length: 42.5 mm
Weight: 11 g



▶ 4-566

Bit adapter 1/4 inch > 4 mm bit

Material quality tool steel, blade length 15 mm, blades Ø 10 mm
Total length: 25 mm
Weight: 6 g



▶ 4-567

Bit adapter 4 mm bits extension 60 mm

Socket 4 mm, material steel-aluminum combination eloxed,
Perfectly combinable with torque adapter set Art.-No. 4-970-KSB
Total length: 60 mm
Weight: 7,5 g



▶ 6-340-2

Bit adapter (5/32) extension 115 mm

Socket 4 mm, material steel-aluminum combination sandblasted,
Perfectly combinable with torque adapter set Art.-No. 4-970-KSB
Total length: 115 mm
Weight: 13 g



▶ 4-565

Flexible bitholder for 4 mm bits

Socket WAF 4 mm, material steel/rubber,
Total length: 200 mm
Weight: 23 g



TORQUE SETS

NEW

▶ 4-970-KSB

Set torque adapter 0.1 - 0.6 Nm 8 pcs (+ 2 adapters)

Torque adapter length 22 mm (without shank), adapter Ø 8 mm, Hex socket 6.35 mm 4.0 mm (5.32")
 Material stainless steel and quality tool steel
 1 bit holder made of aluminium (Art.-No. 4-564)
 1 bit holder made of chrome-plated steel (Art.-No. 4-566)
 In a plastic quadro box
 Weight: 70 g



4-970-KSB

▶ 4-970-G

Set torque adapter 0.1 - 0.6 Nm 8 pcs (+ 2 bit adapters + handle)

Torque adapter length 22 mm (without shank), adapter Ø 8 mm, Hex socket 6.35 mm 4.0 mm (5.32")
 Material stainless steel and quality tool steel
 1 bit holder made of aluminium (Art.-No. 4-564)
 1 bit holder made of chrome-plated steel (Art.-No. 4-566)
 In a plastic quadro box
 Screwdriver handle Art.-No. 4-106
 Weight: 108 g



4-970-G

▶ 4-980-KSB

Torque adapter set 0.6 - 3.0 Nm for 1/4 inch bits

Torque adapter length 39 mm (without shank), adapter Ø 12 mm,
 Hex socket 1/4" (6.35 mm)
 Material stainless steel and quality tool steel
 In a plastic quadro box
 Weight: 141 g



4-980-KSB

▶ 4-980-G

Torque adapter set 0.6 - 3.0 Nm for 1/4 inch bits with handle

Torque adapter length 39 mm (without shank), adapter Ø 12 mm,
 Hex socket 1/4" (6.35 mm)
 Material stainless steel and quality tool steel
 In a plastic quadro box
 screwdriver handle Art.-No. 4-107
 Weight: 198 g



4-980-G

TORQUE SCREWDRIVERS AND SETS

NEW

► 4-930

Bit set with torque screwdriver 0.05 - 0.6 Nm 46 pcs

Material quality tool steel, blade length 15 mm, blades Ø 10 mm

Material steel/aluminium, in plastic case with foam insert

Tolerance: ± 6 %

Weight: 420 g

Art.-No.	Content
4-563	Mini torque screwdriver 0.05 - 0.6 Nm with adapter 4 mm > 6.35 mm
6-340	ESD screwdriver bit set 44 pcs Content see page 105



4-930

► 4-970

Bit set with torque adapter 0.1 - 0.6 Nm 51 pcs

Torque adapter length 22 mm (without shank), adapter Ø 8 mm, hex socket 4.0 mm,

Material stainless steel and quality tool steel, in plastic case with foam insert

Tolerance: ± 10 %

Weight: 427 g

Art.-No.	Content
4-971 - 4-976	Torque adapter 0.1, 0.2, 0.3, 0.4, 0.5, 0.6 Nm for 4 mm bits
4-564	Bit adapter 1/4" > 4 mm bits
6-340	ESD screwdriver bit set 44 pcs Content see page 105



4-970

► 4-970-A / 4-970-B / 4-970-C

Bit-set with 2 torque adapters, 47 pcs

Torque adapter length 22 mm (without shank), adapter Ø 8 mm, hex socket 4.0 mm,

Material stainless steel and quality tool steel, in plastic case with foam insert

Tolerance: ± 10 %

Weight: 410 g

Art.-No.	4-970	Content
4-564	A/B/C	Bit adapter 1/4" > 4mm bits
6-340	A/B/C	ESD screwdriver bit set 44 pcs Content see page 105
4-971 + 4-972	A	Torque adapter 0.1 Nm for 4 mm bits Torque adapter 0.2 Nm for 4 mm bits
4-973 + 4-974	B	Torque adapter 0.3 Nm for 4 mm bits Torque adapter 0.4 Nm for 4 mm bits
4-975 + 4-976	C	Torque adapter 0.5 Nm for 4 mm bits Torque adapter 0.6 Nm for 4 mm bits



4-970-A, 4-970-A, 4-970-C

BITS AND BIT SETS



► 4-909

PEN bit set 23 pcs (22 bits + holder)

Made of high-quality gun metal with powder coating in metallic grey. The set consists of 22 bits and a bit holder in a handy pen design and a magnetic cap with clip. The magazine can be individually equipped with 5 bits. The remaining bits can be stored in the practical synthetic holder.

Weight: 120 g



4-909



Bits	Description
	Square S1
	Pentalobe P2 - P5 - P6
	Torx security T8 - T9 - T10
	Torx 5 - 6 - 7
	Cross-recess 00 - 0 - 1
	Slot 1.5 - 2.0 - 2.5 - 3.0 mm
	Hex 0.9 - 1.3 - 1.5 - 2.0 mm
	Sim eject bit 0.8



► 4-950

Screwdriver set 13 pcs (12 bits within handle)

High-quality aluminium handle with integrated magazine for up to 5 bit blades, Ø 4 mm

Weight: 112 g

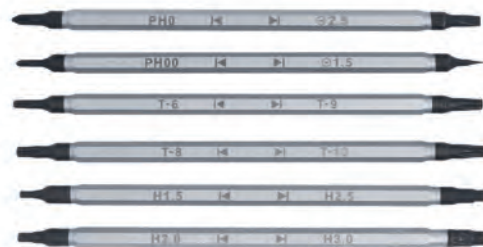

4-950

Bits	Description
	Slot 1.5, 2.5
	Cross-recess PH0, PH00
	Torx T6, T8, T9, T10
	Hex 1.5, 2.0, 2.5, 3.0



p. 76 ESD screwdriver set

BITS AND BIT SETS



▶ 6-340

ESD screwdriver bit set 44 pcs

In combination with the ESD handle (Art.-No. 6-340-1) suitable for all work on electrostatically sensitive components.

Surface resistance: $10^6 - 10^9$ Ohm

Norm: IEC 61340-5-1.

The rotatable centering head guarantees precision.

Extension: Art.-No. 6-340-2 (115 mm)

Material bits: quality steel sandblasted and nickel-plated 52-54 HRC

Weight: 157 g

Bits	Description
	Slot 1.0, 1.5, 2.0, 2.5, 3.0
	Cross-recess PH000, PH00, PH0, PH1
	Torx T3, T4, T5
	Torx security T6, T7, T8, T9, T10, T15
	Triangle 1.6, 2.0, 2.2, 2.3
	Tri-point 0, 1
	Square S0, S1
	Hex 0.9, 1.3, 1.5, 2.0, 2.5, 3.0
	Pentalobe P2, P5, P6
	Socket wrench 2.5, 3.0, 3.5, 4.0, 4.5, 5.0
	SIM eject bit



6-340

▶ 6-340-3

NEW

Screwdriver bit set 42 pcs

3 bit bars equipped with 36 special bits and 1 bit bar with 6 nut setter, C4 shank, 4 mm (5/32") hex, blade length 22 mm, blades \varnothing 8 mm, quality steel sandblasted and nickel-plated 52-54 HRC, Dimensions bars: 65 x 8 x 28 mm

Weight: 117 g



6-340-3

SERVICE SET HANDY REPAIR

p. 109 opening tools

Plastic case, consisting of a black plastic case with foam inlay, suction cup opener, opening tool, conductive ESD tweezers (tip 2.0 mm wide) and a 42 pcs bit set (Art.-No. 6-340-3) with conductive ESD bit screwdriver with rotating cap and 115 mm extension (Art.-No. 6-340-2).

▶ 4-910 ESD screwdriver bit set 47 pcs

Art.-No.	Content
6-340-1	ESD bit holder dissipative for 4 mm (5/32") hex bits ($10^6 - 10^9$ Ohm)
6-340-2	Bit extension für 4 mm (5/32") hex bits
6-340-3	Screwdriver bit set 42 pcs 4 bit bar 4 mm (5/32") hex bits
2-111	LCD opener suction cup with ring (separable M4 thread)
2-124	Opening tool BERNSTEIN metal opener flat
5-059-13	ESD SMD tweezers 120 mm form 2a stainless steel dissipative ($10^6 - 10^9$ Ohm)



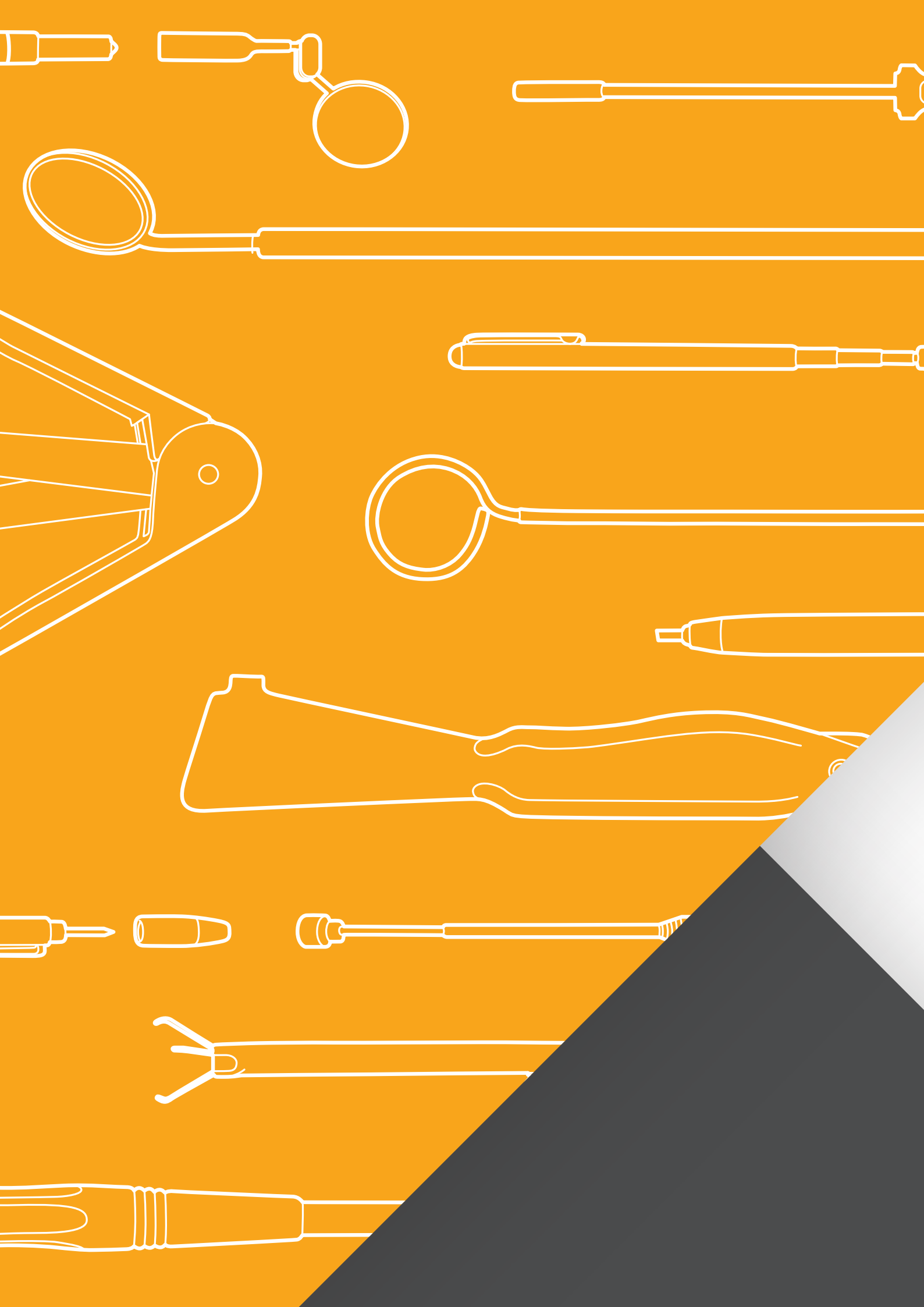

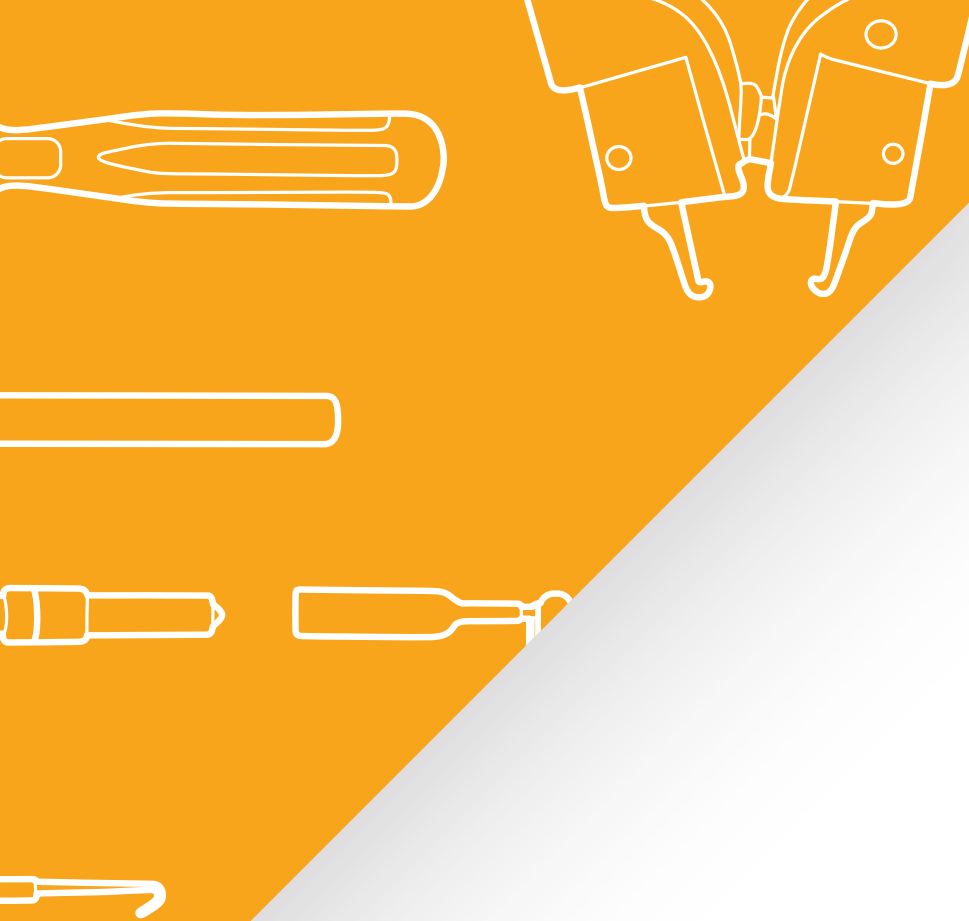

INSPECTION, CLEANING AND OPENING TOOLS – TO MAKE LIFE AT THE WORKPLACE EASIER!

To make life at the workplace easier,
BERNSTEIN also offers little helpers.
On the following pages, you will find cleaning
and testing tools as well as opening and
auxiliary tools.

CLEANING TOOLS

Glass-fibre contact cleaner is a practical helper for users in many areas. They are perfect for cleaning, polishing or sanding the smallest surfaces. These are used in fine work for model building, for example, but the glass-fibre contact cleaner is also ideal for cleaning soldering joints and welds.

Brass wire brushes are practical helpers for cleaning, grinding, scratching and deburring. In particular, dirty threads in inaccessible places can be cleaned and derusted with the help of brass wire erasers.

Art.-No.	Description	Total length in mm	Weight in g
NEW 2-162	Glass fibre contact cleaner brush Ø4mm, plastic body	120	10
2-166	Glass fibre contact cleaner brush Ø4mm, plastic body with metal tip	120	10
2-167-VE10	Replacement glass fibre 35 mm for 2-166 Ø 4 mm (VE10)	35	11
2-163	Brass contact cleaner brush Ø4mm, plastic body with metal tip	120	10
NEW 2-164-VE24	Replacement brush 33 mm (MS) for 2-163 Ø 4 mm (VE 24)	58	41
NEW 2-168	Glass fibre contact cleaner brush Ø 2 mm, with clamp mounting, plastic body with metal tip	140	12
NEW 2-169-VE12	Refill glass fibre 112mm for 2-168 Ø 2mm (VE12)	112	6

Art.-No.	Description	Total length in mm	Weight in g
2-126	ESD desoldering lever slotted at one ends	115	10
2-127	ESD tin knife, pointed sharp blade	115	15
2-128	ESD tin scraper, sharp chisel form	115	14
2-101	Tin knife with ceramic blade	105	9

INSPECTION TOOLS

BERNSTEIN test prods are especially thin, pointed and flexible. The fully insulated and flexible design of the test prods prevents short circuits and damage during testing and measuring, even when contacts are arranged one after another.

Art.-No.	Description	Total length in mm	Weight in g
2-265-1	Test prod red, blade 1 mm, Rated voltage CAT I: 60V (DC/30V CAC)	155	9
2-265-2	Test prod black, blade 1 mm, Rated voltage CAT I: 60V (DC/30V CAC)	155	9

Art.-No.	Description	Total length in mm	Weight in g
1-909	Engineer mirror, magnifying, Ø 23 mm, with extension	145-260	9
1-978	Engineer mirror, magnifying, Ø 23 mm, with extension, with 6 mm blade at the end	145-260	9
2-275	Magnifying mirror Ø 21 mm	180	8
2-282	Inspection mirror telescopic rod, 360° rotatable joint	150-610	23
2-292	Magnifier 3.25 x Ø 45 mm with additional lens	70	35
2-293	Hand magnifier 3 x Ø 65 mm antistatic coating	180	54
2-296	Hand magnifier 3x magnification LED light	112 - 172	18
2-656	LED flashlight, waterproof with clip	140	40



OPENING TOOLS

Opening tools for opening hard-to-reach electronic devices such as smartphones, tablets, notebooks, and many more.

Art.-No.	Description	Total length in mm	Weight in g
2-113	ESD opening tool	176	22
2-123	ESD crowbar SPUDGER metal opener flat	180	19
2-124	Opening tool BERNSTEIN metal opener flat	120	12
2-129	opening tools synthetic 10 pcs	—	52
2-111-VE3	LCD suction cup with ring (PU 3)	—	50

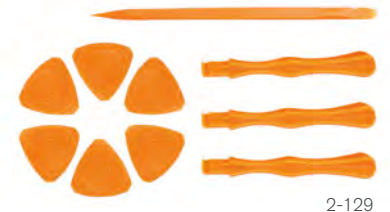

AUXILIARY TOOLS

Art.-No.	Description	Total length in mm	Weight in g
2-119	Magnetic mat with pen Rewritable pad for the repair of small electronic devices, smartphones, etc.	250 x 200	200
2-155	claw-type gripper, 3 hardened wire claws	165	50
2-155-13	ESD claw-type gripper, 3 hardened wire claws, dissipative	165	60
2-157	Flexible claw-type gripper with 4 spring claws	600	75
2-161	Scriber, magnetic lifter with telescopic slide-out	145-655	34
2-130	Set of spring pullers 6 pcs	204	39
2-131	Spring puller 205 mm	205	10
2-132	Spring puller 175 mm	175	8
2-133	Spring puller with ring	195	12
2-605	PLCC-puller	135	5
2-620	PLCC-extractor	100	21



► 2-130

Set of spring pullers 6 pcs

In plastic insert pocket, various shapes for gripping and straightening springs
Weight: 39 g



2-130

► 2-800

Miniature tap and die set 30 pcs (M1.0 - M2.5 mm)

A tap and die set with a taper and bottoming tap for each size. The set also includes a die holder as well as two matching reducing rings. The reducing rings are used to also mount the taps into the die holder.

Content:

each 2 x hand taps (HGB) M1.0 - 1.1 - 1.2 - 1.4 - 1.6 - 1.8 - 2.0 - 2.2 - 2.5

each 1 x dies M1.0 - 1.1 - 1.2 - 1.4 - 1.6 - 1.8 - 2.0 - 2.2 - 2.5

1 x die holder

2 x tap wrenches

Weight: 199 g



2-800

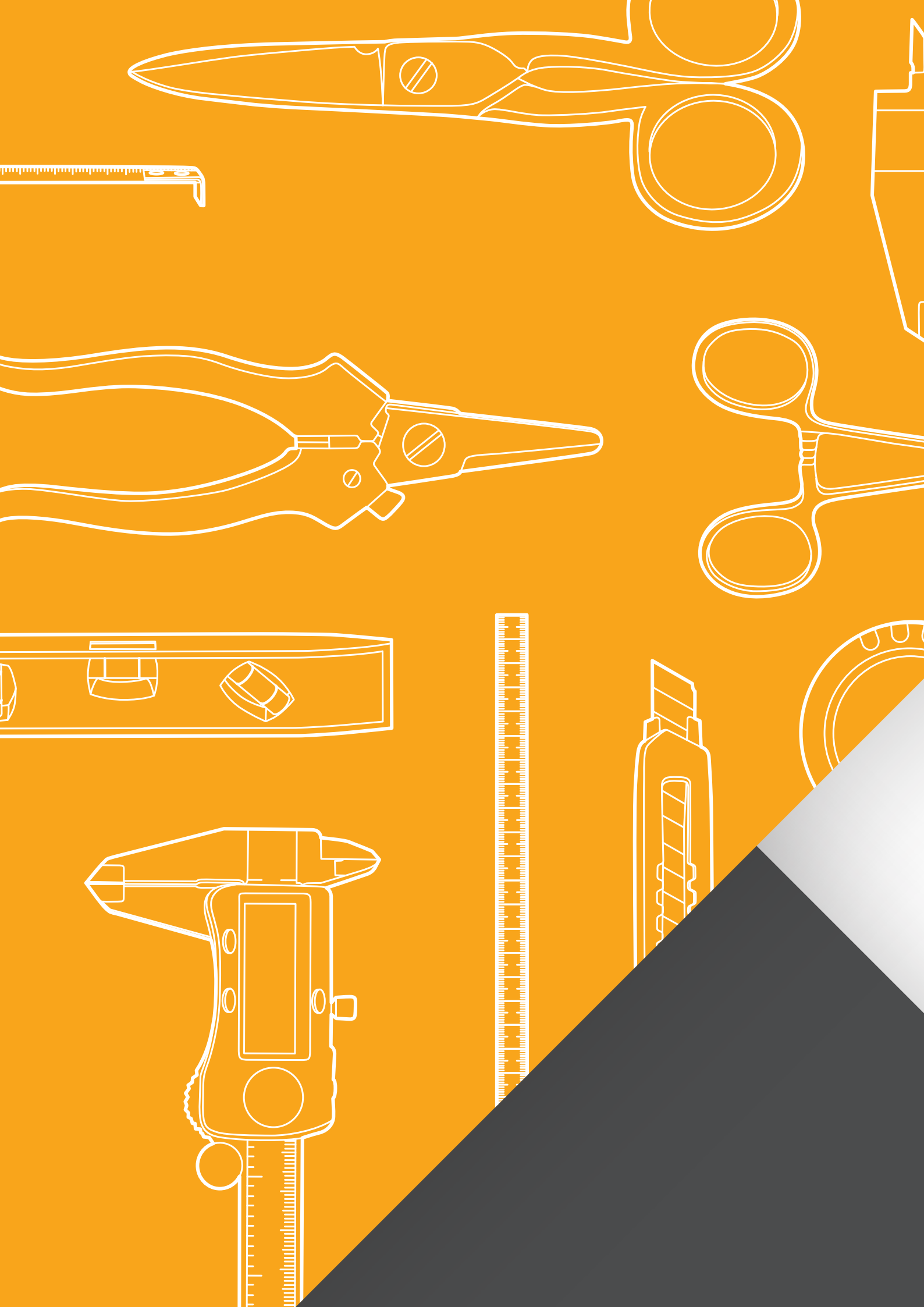

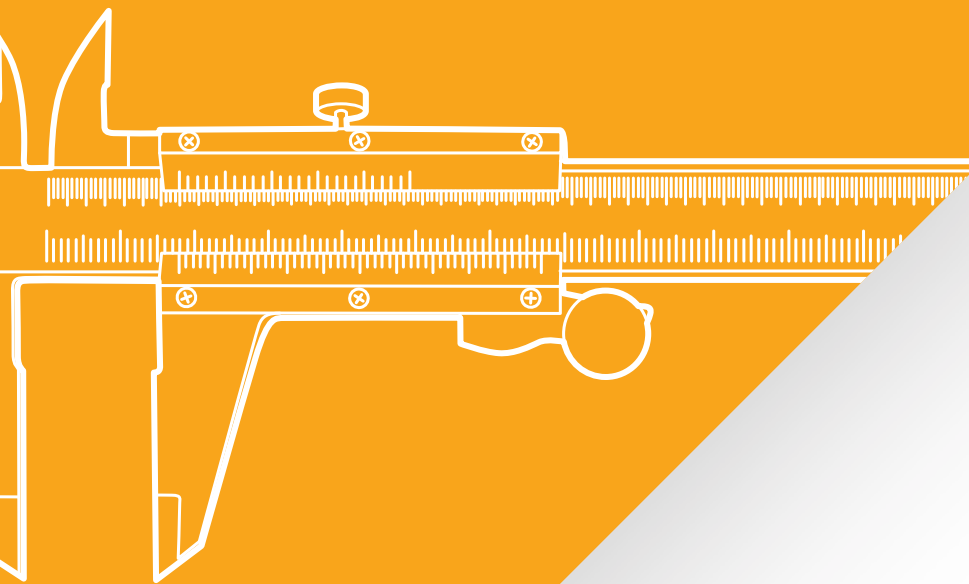

CUTTING AND MEASURING TOOLS

Testing, measuring and cutting tools are the most important tools and a part of the standard equipment of any workbench or toolbox.

Bernstein offers various tools for inspecting, measuring and servicing components or assemblies.

CLIPPERS AND KNIVES

We selected the geometry of our clippers and knives based on our customers' requirements. You will find the right cutting tool depending on the application.

CALLIPERS

Callipers can be used to measure internal dimensions, external dimensions and depth dimensions.

FOLDING RULERS AND MEASURING TAPES

It couldn't be simpler – the folding ruler. One of the oldest measuring tools, but also one of the most important. We offer various measuring equipment in this field – from short to long.

SCISSORS

p. 123 Stripping tools

► 5-161

Clamping scissors with teething jaws

for holding and clamping, no cutting function. Serrated on both sides. Jaw length 25 mm
Material high quality steel, stainless
Total length: 130 mm, weight: 80 g



► 5-301

Scissors with teething

One blade micro serrated, cutting length 15 mm
Material high quality steel, stainless
Total length: 110 mm, weight: 27 g



► 5-301-13

NEW

ESD scissors with teething, dissipative

One blade micro serrated, cutting length 15 mm
Material high quality steel, stainless, dissipative between 10⁶ and 10⁹ ohm
Total length: 110 mm, weight: 27 g



► 5-302

Electrician scissors with toothing

stripping function, very stable and robust scissor, cutting length 45 mm
Material high quality steel, stainless
Total length: 130 mm, weight: 67 g



► 5-305

Combination scissors, slicer

smooth cutting edge, one-sided external toothing, cutting length 30 mm
Compression spring and lock. Material high quality steel, stainless
Total length: 145 mm, weight: 58 g



► 5-306

Scissors, black lacquered, polished head

No ESD! Cutting length 30 mm
Material high quality steel, stainless
Total length: 180 mm, weight: 85 g



► 5-308

Scissors with fine teething

Telephone and cable scissors with fine serration on one side on the inside, cutting length 45 mm
Material high quality steel, stainless
Total length: 125 mm, weight: 59 g



► 5-308-13

NEW

ESD scissors with fine teething, dissipative

ESD - telephone and cable scissors with fine serration on one side on the inside, cutting length 45 mm
Material high quality steel, stainless, with ESD-coating, dissipative between 10⁶ and 10⁹ ohm
Total length: 125 mm, weight: 61 g



► 5-311

Kitchen scissors

very stable and robust scissor, smooth and sharp cutting edges, cutting length 70 mm
Material high quality steel, stainless
Total length: 180 mm, weight: 80 g



SCISSORS AND KNIVES

▶ **5-310**

Scissors with round tips

Smooth precision cutting, cutting length 45 mm
Material high quality steel, stainless
Total length: 130 mm, weight: 55 g



5-310

▶ **5-310-13**

NEW

ESD scissors rounded, dissipative

Material high quality steel, stainless, cutting length 45 mm
coating dissipative between 10^6 and 10^9 ohm
Total length: 130 mm, weight: 58 g



5-310-13

▶ **5-352**

ESD scissors with dissipative handle

Material high quality steel, cutting length 80 mm, handle dissipative between 10^6 to 10^9 ohm
For working in electrostatically protected areas (ESD workplace).
Total length: 180 mm, weight: 55 g



5-352

▶ **5-353**

Ceramic scissors with plastic handle

Ceramic cutting edges, for cutting kevlar and aramid fibers, antistatic and electrically insulating,
black glass-fibre reinforced synthetic handles, cutting length 75 mm
Total length: 190 mm, weight 80 g



5-353

▶ **5-515**

NEW

Cutter knife

Blades made of special stainless steel 9 mm, blade strips adjustable and breakable.
Material metal body, powder coated, replacement blades (VE 10) Art.-Nr. 5-517
Total length: 140 mm, weight: 10 g



▶ **5-517**

NEW

Cutter knife

Blades made of special stainless steel 18 mm, blade strips adjustable and breakable.
Case made from plastic, replacement blades (VE 10) Art.-No. 5-518
Total length: 160 mm, weight: 55 g



5-517

▶ **5-519**

ESD cutter knife dissipative

Blades made of special stainless steel 18 mm, blade strips adjustable and breakable.
For cutting and separation of all materials, for working in electrostatically protected areas
ABS plastic case, surface resistance: 10^6 - 10^8 Ohm.
Replacement blades (VE 10) Art.-Nr. 5-518
Total length: 140 mm, weight: 39 g



5-519

▶ **2-102**

NEW

Scalpel handle set with 5 blades

Total length: 125 mm, weight: 3 g

Art.-No.	Content	Art.-No.	Content
2-102-1	Scalpel handle	2-102-4	Blade no. 11 (5 x 42 mm)
2-102-2	Blade no. 10 (7 x 42 mm)	2-102-5	Blade no. 12 (6 x 40 mm)
2-102-3	Blade no. 10 A (8 x 42 mm)	2-102-6	Blade no. 13 (7 x 42 mm)



2-102-2

2-102-1



2-102-3

2-102-4



2-102-5

2-102-6

MEASURING TOOLS

▶ 7-502

Folding rule 2 meters

Material wood
Total length folded 240 x 15 mm, weight: 120 g



7-502

▶ 7-503

Folding rule 1 Meter

Material plastic
Total length folded 130 x 13 mm, weight: 60 g



7-503

▶ 7-506

Roller tape measure 2 Meter

Shockproof synthetic body
Total length: 55 mm, weight: 70 g



7-506

▶ 7-508

Steel tape measure 30 cm

Cross section 13 x 0,5 x 300 mm stainless steel,
Lines and numbers etched and dyed black
Total length: 320 mm, weight: 20 g



7-508

▶ 7-515

Feeler gauge 21 blades (0.05 - 2.0 mm)

With conical blades, measuring range 0.05 - 2.0 mm, cover sheet nickel plated with locking screw

Material: INOX stainless steel

T2 TOLERANCES:

Nominal thickness 0.03 / 0.04 / 0.05 / 0.06 +/- 0.004 mm

Nominal thickness 0.07 / 0.08 / 0.09 / 0.10 +/- 0.005 mm

Nominal thickness 0.11 / 0.12 / 0.13 +/- 0.005 mm

Nominal thickness 0.14 / 0.15 +/- 0.006 mm

Nominal thickness 0.16 / 0.18 +/- 0.007 mm

Nominal thickness 0.20 +/- 0.008 mm

Total length: 100 mm, weight: 190 g



7-515

▶ 7-521

Scriber 200 mm

For marking, scribing, scoring, engraving, one side bent 90°

Needles hardened and burnished, Ø 2,5 mm

Aluminum handle Ø 6 mm, finely knurled for optimum grip

Material aluminum/tool steel

Total length: 200 mm, weight: 26 g



7-521

▶ 7-535

Spirit level 225 mm

Material plastic, with horizontal, vertical and 45° level

Total length: 225 mm, weight: 58 g



7-535

▶ 7-509

Digital calliper plastic display 100 mm

Measuring range 100 mm, tolerance 0.001 mm, 5-digit LCD display, with locking screw,
 Bottom beak 30 mm top 10 mm, pointers, depth rod
 Material quality steel, hardened, stainless, in a plastic case
 Total length: 170 mm, weight: 185 g



7-509

▶ 7-511

Digital calliper DIN862, 150 mm

Measuring range 150 mm, tolerance 0.001 mm, 5-digit LCD display, with locking screw,
 Bottom beak 40 mm top 10 mm, pointers, depth rod
 Material quality steel, hardened, stainless, in a plastic case
 Total length: 250 mm, weight: 200 g



7-511

▶ 7-512

Digital calliper MINI steel display 100 mm

Measuring range 100 mm, tolerance 0.001 mm, 5-digit LCD display, with locking screw,
 Bottom beak 30 mm top 10 mm, pointers, depth rod
 Material quality steel, hardened, stainless, in a plastic case
 Total length: 180 mm, weight: 110 g



7-512

▶ 7-513

Digital calliper steel display 150 mm

Measuring range 150 mm, tolerance 0.001 mm, 5-digit LCD display,
 with locking screw, Bottom beak 40 mm top 10 mm, pointers, depth rod
 Material quality steel, hardened, stainless, in a plastic case
 Total length: 235 mm, weight: 200 g



7-513

▶ 7-514

Digital plastic calliper 100 mm

Measuring range 100 mm, tolerance 0.001 mm, 5-digit LCD display, with locking screw,
 Bottom beak 30 mm top 10 mm, pointers, depth rod
 Material quality steel, hardened, stainless, in a plastic case
 Total length: 180 mm, weight: 60 g



7-514

▶ 7-516

NEW**Analogue calliper 150 x 0.05 mm**

In a stable plastic box, measuring range 150 mm,
 Tolerance 0.05 mm, bottom beak 40 mm, top 10 mm
 Material quality steel, hardened, stainless
 Total length: 230 mm, weight: 150 g



7-516

Further information about our calipers can be found on our website.



HAND TOOLS

BERNSTEIN offers different traditional tools for labour-intensive work at the workplace. Whether hammers, files, saws or spatulas – you will find a selection of our popular products in this chapter.

FILES

► 5-210

Needle files set 6 pcs

24 strokes on 1 cm, in plastic case, without handle

Weight: 50 g

The following types are available, specifications in mm:

Art.-No.	Type	Handle length	Total length	Weight in g
5-201	flat-blunt	100	140	7
5-202	flat-pointed	100	140	6
5-203	round	100	140	6
5-204	half round	100	140	6
5-205	triangular	100	140	6
5-206	square	100	140	6



5-210

► 5-240

Warding files set 6 pcs

22 strokes on 1 cm, in plastic case, with handle

Weight: 120 g

The following types are available, specifications in mm:

Art.-No.	Type	Handle length	Total length	Weight in g
5-231	flat-blunt	67	170	17
5-232	flat-pointed	67	170	14
5-233	round	67	170	13
5-234	half round	67	170	27
5-235	triangular	67	170	18
5-236	square	67	170	15



5-240

► 5-261

Contact file

With fine stroke, flat-blunt, 22 strokes on 1 cm

Total length: 150 mm, weight: 9 g



5-261

HAND TOOLS

► Engineer hammer according to DIN 1041

Drop forged, precision ground, tiller and track precision ground, varnished and rust-protected, with double curved ash handle

The following types are available, specifications in mm:

Art.-No.	Total length	Head weight in g	Total weight in g
7-114	280	200	260
7-116	300	300	435

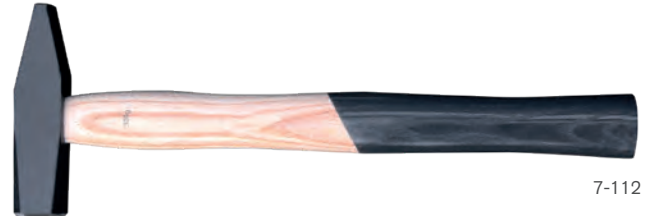

► Plastic hammers

With impact-resistant plastic inserts, lacquered handle

The following types are available, specifications in mm:

Art.-No.	Total length	Head- Ø	Total weight in g
7-121	255	22	130
7-122	270	27	225
7-123	275	32	330



► 7-616

PUK saw

In case, with adjustable wooden handle and saw blade for wood and metal
Total length: 245 mm, span width: 150 mm
Weight: 140 g



► 7-617

Hack saw blade

Suitable for „PUK“-saws, VE 12
Total length: 150 mm
Weight: 3 g



► 7-405

Painter's spatula

With conical forged leaf and wooden handle
Blade width: 50 mm,
Total length: 215 mm, weight: 70 g



► 7-410

Slicker trowel

Polished with round stalk, blade width: 16 mm,
Total length: 220 mm, weight: 25 g



► 7-435

Oiler, 40 ml

Plastic, captive brass twist lock
Total length: 150 mm
Weight: 15 g

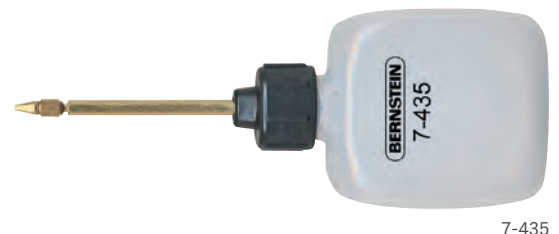

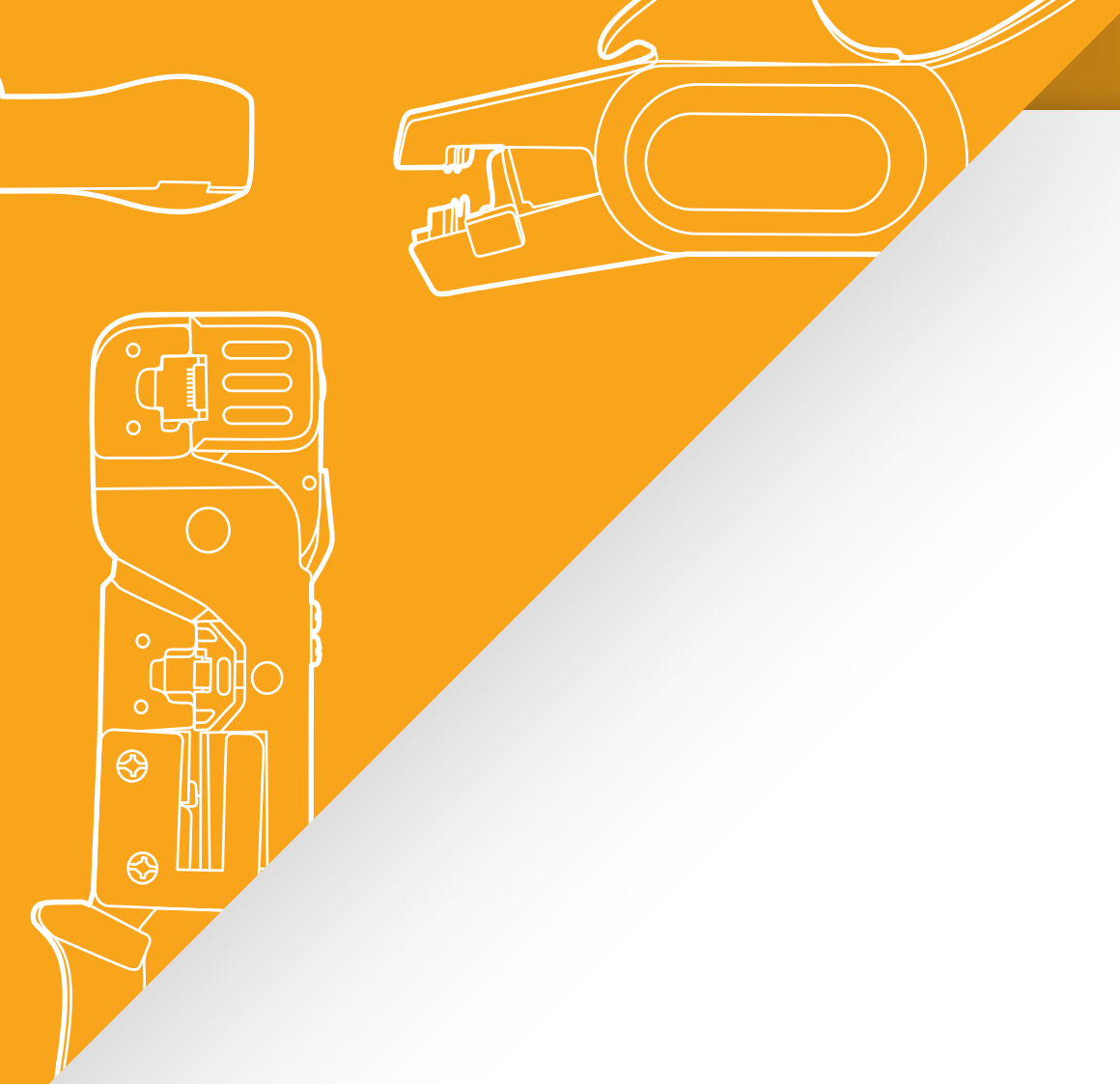

STRIPPING AND CRIMPING TOOLS - ALL ABOUT CABLES

Our multifunctional wire strippers are designed with factors of efficiency in mind, as time is money. Cable stripping, round cuts, long cuts, skinning, everything is possible with just one tool and often including an adjustable length stop.

We also offer wire strippers in different models for all common flexible and solid conductors. In addition, we sell all types of cable stripping knives and clippers (see the chapter „Cutting and measuring“) for the reliable, precise and fast stripping of wires.

The pinch-free cut is necessary for effortless crimping in order to assemble conductors with sleeves and connectors. Here, BERNSTEIN offers a comprehensive range of crimping tools to meet various requirements.

STRIPPING KNIVES

► 5-501

Cable knife (open 200 mm)

Cable knife with steel blade, wooden shells and wire scraper.
Total length: 200 mm
Weight: 78 g



5-501

► 5-503

Cable knife Ø 8 - 22 mm

For precise, fast and safe stripping of all common round cables from Ø 8 - 28 mm, cutting depth adjustment by adjusting screw at the handle end, the rotating inner blade automatically switches from round to longitudinal cutting.
Total length: 140 mm
Weight: 68 g



5-503

► 5-504

Cable knife Ø 4 - 16 mm

For precise, fast and safe stripping of all common round cables from Ø 4 - 16 mm, cutting depth adjustment by adjusting screw at the handle end, the rotating inner blade automatically switches from round to longitudinal cutting.
Total length: 140 mm
Weight: 66 g



5-504

► 5-505

Stripping knife Ø 4 - 28 mm with hookblade

For precise, fast and safe stripping of all common round cables from Ø 4 - 28 mm, cutting depth adjustment by adjusting screw at the handle end, the rotating inner blade automatically switches from round to longitudinal cutting.
Total length: 185 mm
Weight: 78 g



5-505

► 5-506

Stripping knife Ø 4 - 28 mm with straight blade

For precise, fast and safe stripping of all common round cables from Ø 4 - 28 mm, cutting depth adjustment by adjusting screw at the handle end, the rotating inner blade automatically switches from round to longitudinal cutting.
Total length: 180 mm
Weight: 82 g



5-506

Application pictures:
apply to
5-503, 5-504, 5-505, 5-506



turning out the knife



longitudinal section



cross section

ESD STRIPPING TOOLS

► 5-542

ESD precision stripper Ø 0,25 - 0,80 mm (AWG 20 - 30)

Precision Stripper ESD Plus for applications in fields where electrostatic discharge could damage components. Particularly suitable for conductors with external insulation made of PVC, Teflon, KYNAR, TEFZEL, MYLAR. With dissipative plastic body.
Total length: 102 mm
Weight: 28 g



5-542

STRIPPING TOOLS

► **5-532** **NEW**

Stripping and crimping tools 0,5 - 6 mm² with stop

Stripping and crimping tool for professional stripping, crimping and cutting with only one tool, automatic adjustment to the conductor cross-section, stranded conductors can be twisted afterwards, simple stripping of 0.5 - 6.0 mm². blades made of special stainless steel, plastic body stripping length 5 mm, crimping ranges for terminals: 0.5 - 2.5 und 4.0 - 6.0 mm², cutting capacity of the side cutters max. 6.0 mm², conductors max. 4.0 mm².
Total length: 160 mm
Weight: 114 g



5-532

► **5-535** **NEW**

Coax cable stripperr Ø 4,8 - 7,5 mm

Coaxial strippers for gradual stripping of all common coaxial cables (for example antennas and transmission cables) and flexible cables Coaxial cables of Ø 4.8 - 7.5 mm. NYM 3 x 0.75 mm², for flexible cables 10 mm² and 16 mm². blades made of special stainless steel, plastic body
Total length: 110 mm
Weight: 27 g



5-535

► **5-533** **NEW**

Stripping tools for data lines

Data-Strip stripping tool for stripping data cables, telephone lines, control cables and special cables. date cord: Ø 4 - 10 mm control lines: Ø 0,2 - 0,8 mm, adjustable inner knife 0,2 - 1,4 mm, site cutter, plastic body
Total length: 125 mm
Weight: 62 g



5-533

► **5-534** **NEW**

Data cable stripper Ø 4,5 - 10 mm

Date cable stripper with ergonomically shaped handles, no adjustment of the cutting depth required, also for hard-to-reach places, e.g. in ceiling and wall areas, in junction and distribution boxes, switch cabinets, etc. Suitable for u.a. Cat5, Cat6, Cat7, twisted pair cable, Ø 4.5 - 10 mm.
Total length: 125 mm
Weight: 41 g



5-534

► **5-536** **NEW**

Round cable stripper Ø 8 - 13 mm

Round cable stripper with ergonomically shaped handles, no adjustment of the cutting depth required, also for hard-to-reach places, e.g. in ceiling and wall areas, in junction and distribution boxes, switch cabinets, etc. Blades made of special stainless steel
For all common round and wet room cables 45 from Ø 8 - 13 mm, eg. NYM 3 x 1.5 mm² to 5 x 2.5 mm². Plastic body
Total length: 125 mm
Weight: 41 g



5-536



Application example 5-532



Application example 5-535, 5-534, 5-536

► **5-0605**

Stripping tool with adjustable knives

Universal stripping tools Handy synthetic design with adjustable knives, easy handling. Blades made of special stainless steel, non-slip
Total length: 100 mm
Weight: 38 g



5-0605

STRIPPING TOOLS

p. 141

VDE
Cutting tools

► **5-531**

Automatic wire stripper 0.2 - 6 mm² mit Anschlag

Automatic stripping pliers for all common flexible and solid conductors from 0.2 - 6.0 mm², adjustable length stop from 5 - 12 mm, if required with removable integrated side cutter up to max. Ø 2 mm. Blades made of special stainless steel, plastic body, non-slip
Total length: 190 mm
Weight: 106 g



5-531-10



5-531

► **5-531-10**

Replacement knives for Art.-No. 5-531 (pair)

Blades made of special stainless steel
Weight: 20 g

► **3-0856**

Crimping pliers/wire stripper

Cable lug pliers for insulated and non-insulated cable lugs. Tool steel (HRC 54 - 56), surface burnished, insulated handle, non-slip.
Total length: 230 mm
Weight: 300 g



3-0856

► **3-815-16**

Wire stripper with adjusting screw and opening spring

Inserted joint stripping pliers with adjusting screw for all wire thicknesses, with compression spring high-quality steel (HRC 54 - 56), 2-component plastic ergonomically formed, non-slip.
Total length: 160 mm
Weight: 120 g



5-815-16

► **5-181**

Wire scraper tweezers 125mm

For removal of varnish insulation on copper wires.
Weight: 33 g
Replacement knives: Art.-No. 5-182



5-181

INSERTION TOOL

► **2-701**

LSA-Plus insertion tool

KRONE LSA-Plus termination tool for non-soldering, non-screwing and non-stripping connection of the wires and at the same time cutting off the remaining lengths, on strips or boxes. For laying data cables on data outlets or patch panels. Application tool for all data, information and telecommunication cabling, applicable for all LSA-PLUS® series as well as RJ45 sockets and highband, for connecting conductor diameters (0.35-0.9mm) and core diameters (0.7-2.6mm).
Total length: 185 mm
Weight: 62 g



2-701

► **2-702**

Termination tool for system 71

Termination tool for non-soldering, non-screwing and non-stripping connection of the wires and at the same time cutting off the remaining lengths, on strips or boxes. For laying data cables on data outlets or patch panels. Termination tool for non-soldering, non-screwing and non-stripping connection of the wires and at the same time cutting off the remaining lengths, on strips or boxes. For laying data cables on data outlets or patch panels.
Total length: 185 mm
Weight: 62 g

Application advices on our homepage.



2-702

CRIMPING TOOLS

▶ 3-0601

Crimping pliers for connector types HT-2094C

Pliers made of solid metal, with interchangeable blades, spring and closed lock, for cutting, cable stripping and crimping of the most common connector types.

Tool steel (HRC 54 - 56), blades made of special stainless steel, plastic handle
Replacement knives: Art.-No. 3-0601-00 (VE6)

Total length: 200 mm, Weight: 320 g



3-0601

▶ 3-0603

Cricrimping pliers for connector types HT-210C

Crimping pliers, solid metal design, replaceable blades, spring and locking device, for cutting, stripping and crimping of the most common connector types. 8P/8C,

Tool steel (HRC 54 - 56), blades made of special stainless steel, plastic handle

Ersatzmesser: Art.-Nr. 3-0601-00 (VE6)

Total length: 200 mm, Weight: 320 g



3-0603

▶ 3-0605

Combination modular crimping pliers

Solid metal pliers with interchangeable blades, spring and closed locking mechanism,

for cutting, stripping and crimping the most common connector types. 6P/6C - 6P/4C - 6P/2C - 8P/8C tool steel (HRC 54 - 56), special stainless steel blades, plastic handle

Replacement knives: Art.-No. 3-0605-00

Total length: 200 mm, Weight: 320 g



3-0605

▶ 3-0609

Universal crimping pliers

Universal crimping pliers, patented design robust metal pliers, for cutting, stripping and crimping, exchangeable knives, spring and locking device, ratchet mechanism.

For 4P4C - 4P2C - 6P6C/RJ - 12 - 6P4C/RJ - 11 - 8P8C/RJ45 - DEC 6P6C,

Tool steel (HRC 54 - 56), Klingen aus rostfreiem Spezialstahl

Replacement knives: Art.-No. 3-0609-00

Total length: 200 mm, Weight: 520 g



3-0609

▶ 3-0611

Crimping pliers for BNC and TNC coaxial connectors

For BNC and TNC coaxial connectors, with ratchet lock and automatic release, suitable for internal contacts and external receptacles. Tool steel (HRC 54 - 56), surface burnished

Pressing range:

hexagon socket for all inner contacts. Crimp length 2.3 mm inner-Ø (0.068 inch) 1.73 mm.

Small hex for RG 58 crimp length 10.0 mm inner-Ø (0.213 inch) 5.41 mm.

Middle hex for RG 59/62 crimp length 10.0 mm inner-Ø (0.256 inch) 6.50 mm.

Large hex for RG 6 crimp length 10.0 mm inner-Ø (0.319 inch) 8.10 mm.

Replacement knives: Art.-No. 3-0611-00

Total length: 200 mm, Weight: 520 g



3-0611

▶ 3-0612

Automatic crimping pliers

Automatic crimping pliers ratchet mechanism for crimping insulated terminals. version: 0.5 - 1.0 / 1.5 -

2.5 / 4 - 6 mm² (AWG 22 - 18 / 16 - 14 / 12 - 10) tool steel (HRC 54 - 56), surface burnished

Total length: 200 mm, Weight: 520 g



3-0612

▶ 3-871-6

Pressing pliers 155 mm for wire 0.25 - 2.5 mm²

Crimping pliers, for wire end ferrules combined with wire cutter and stripping frames, for various wire thicknesses, for wire end ferrules from 0.25 - 2.5 mm² carbon steel.

surface matt chrome plated, high-quality steel (HRC 54 - 56), handle dipped insulation, non-slip

Total length: 155 mm, Weight: 165 g



3-871-6

▶ 3-875-6

Pressing pliers 255 mm for wire 0.5 - 16.0 mm²

Crimping pliers, for wire end ferrules combined with wire cutter and stripping frames, for various wire thicknesses, for wire end ferrules from 0.50 - 16.0 mm² carbon steel.

surface matt chrome plated, high-quality steel (HRC 54 - 56), handle dipped insulation, non-slip

Total length: 226 mm, Weight: 285 g



3-875-6

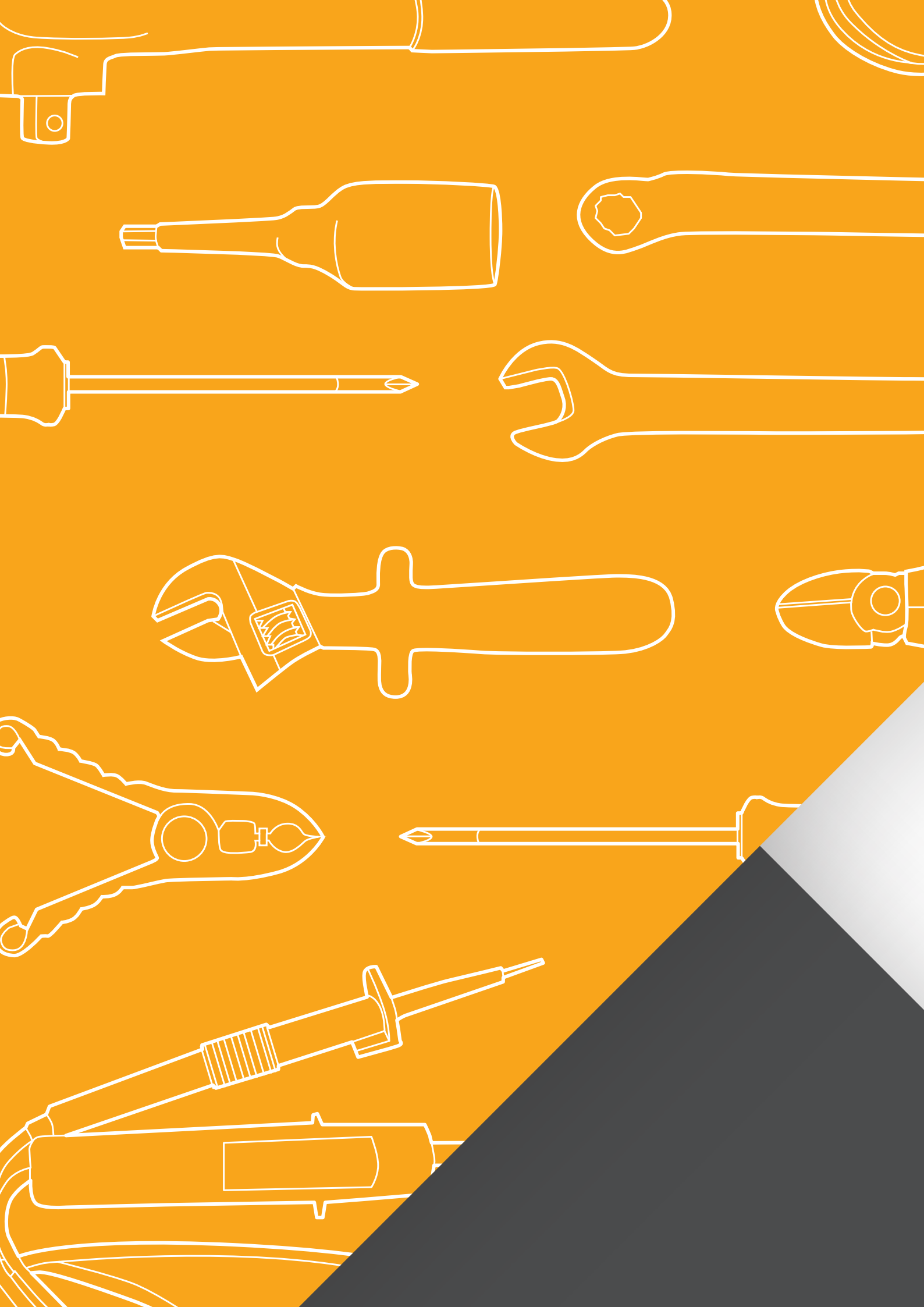



VDE TOOLS – WORKING UNDER TENSION

Working under tension is always a highly explosive undertaking. Here it is absolutely necessary safety precautions to be taken into account. Work under voltage" may only be carried out by appropriately trained electricians. The skilled personnel can assess the required security precautions. The protective devices (covers, enclosures or insulating sheaths) must be selected and installed in such a way as to eliminate any risk of electrical or mechanical overloading. All our insulated tools are individually tested according to VDE regulations IEC 60900 / EN 60900 and are therefore approved for work under a voltage of AC 1,000 V and DC 1,500 V.

UNIT-TESTED SAFETY

Voltage test

Unit-tested safety, tested with 10,000 V, approved for 1000 V. This means 10-fold safety.

Coating thickness measurement

Load with 20 N. No breakdown shall occur at 70° C when tested with a voltage of 5000 V AC.

Withdrawal force check

the adhesion of the PVC coating to 500 N or 50 N after 168 hours of storage at 70° C.

8100 VDE TOOL CASE SAFETY

A case full of safety for work under voltage up to 1000 volts.
The tools have VDE two-colour multilayer immersion insulation or VDE 1- or 2-component grip cover.



and / or



► **8100 Werkzeugkoffer SAFETY 35 pcs (incl. case)**

► **8110 Werkzeugkoffer SAFETY 33 pcs (incl. case), without 17-501 and 17-521**



NEW

Art.-No.	Content
8115 VDE	Leather tool case 35 empty pockets
1500-09	Shoulder strap with protection, leather black
4-344 VDE	VDE voltage tester slot blade 3.5 x 0.7 x 110 mm
13-106 VDE	VDE side cutters 165mm
13-207 VDE	VDE telephone pliers 205mm serrated jaws, straight, with wire cutter
13-208 VDE	VDE telephone pliers 205mm serrated jaws, bent, with wire cutter
13-708 VDE	VDE combination pliers 210mm serrated jaws
13-806 VDE	VDE wire strippers 165mm with stop screw
14-652 VDE	VDE screwdriver slot blade 3.5x100mm
14-653 VDE	VDE screwdriver slot blade 4.0 x 100 mm
14-654 VDE	VDE screwdriver slot blade 5.5 x 125 mm
14-656 VDE	VDE screwdriver slot blade 6.5 x 150 mm
14-658 VDE	VDE screwdriver slot blade 8.0 x 175 mm
14-682 VDE	VDE screwdriver cross-recess PH1 Ø 4.5 mm
14-683 VDE	VDE screwdriver cross-recess PH2 Ø 6.0 mm
15-522 VDE	VDE cable dismantling knife with hook blade
16-441 VDE	VDE socket 1/2 inch 10.0mm
16-442 VDE	VDE socket 1/2 inch 11.0 mm
16-443 VDE	VDE socket 1/2 inch 12.0 mm

Art.-No.	Content
16-444 VDE	VDE socket 1/2 inch 13.0 mm
16-445 VDE	VDE socket 1/2 inch 14.0 mm
16-447 VDE	VDE socket 1/2 inch 17.0 mm
16-448 VDE	VDE socket 1/2 inch 19.0 mm
16-449 VDE	VDE socket 1/2 inch 22.0 mm
16-451 VDE	VDE socket 1/2 inch 24.0 mm
16-471 VDE	VDE reversible ratchet 1/2 inch
16-476 VDE	VDE reversible ratchet 1/2 inch
16-503 VDE	VDE single-ended open-end wrench 8.0mm
16-504 VDE	VDE single-ended open-end wrench 9.0 mm
16-505 VDE	VDE single-ended open-end wrench 10.0 mm
16-506 VDE	VDE single-ended open-end wrench 11.0 mm
16-507 VDE	VDE single-ended open-end wrench 12.0 mm
16-508 VDE	VDE single-ended open-end wrench 13.0 mm
16-509 VDE	VDE single-ended open-end wrench 14.0 mm
17-501 VDE	VDE protective gloves size 10 – not included in 8110 –
17-521 VDE	VDE plug-in-grip with leather gauntlet – not included in 8110 –
17-523 VDE	VDE plastic clip with internal spiral spring

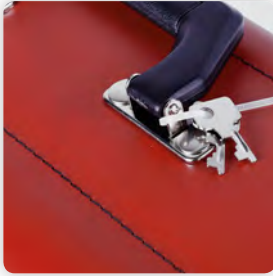

► 8100 VDE



An incredibly sturdy case made from cowhide in bright red. The front board is hinged, providing quick access to 35 tools which are stored in pockets and in the bottom tray. Behind the tool set there are additional compartments for safety gloves, an NH handle, circuit diagrams or various written documents. The case has two locks and eyelets on the sides for hooking in the carrying strap. A padded shoulder strap is also included.

BERNSTEIN safety tools are insulated and individually tested in accordance with VDE regulations IEC 60900 / EN 60900, guaranteeing maximum safety. The two-colour multilayer immersion insulation makes any damage to the outer red insulation immediately visible due to the yellow insulation underneath. The advantage is that a simple safety check can be carried out at any time.



Outer dimensions: 440 x 175 x 310 mm
(closed)



Without tools: 3000 g
With tools: 7500 g



35 tools



8100 SAFETY with tools
8115 SAFETY without tools

8150 VDE TOOL SET IN PLASTIC CASE

Safety tools in a synthetic case for work with voltages of up to 1000 volts. The tools have VDE two-colour multilayer dipped insulation and a VDE 1-component or 2-component grip cover.



BERNSTEIN safety tools are insulated and individually tested in accordance with VDE regulations IEC 60900 / EN 60900, guaranteeing maximum safety. The two-colour multilayer dip insulated makes any damage to the outer red insulation immediately visible due to the yellow insulation underneath. The advantage is that a simple safety check can be carried out at any time.

► 8150 VDE Tool case set 24 pcs (incl. case)

Art.-No.	Content	Art.-No.	Content
8150-10	Plastic case with foam inlay empty	16-445 VDE	VDE socket 1/2 inch 14.0 mm
13-106 VDE	VDE side cutters 165mm	16-447 VDE	VDE socket 1/2 inch 17.0 mm
13-708 VDE	VDE combination pliers 210mm serrated jaws	16-448 VDE	VDE socket 1/2 inch 19.0 mm
14-651 VDE	VDE screwdriver slot blade 2.5 x 75 mm	16-475 VDE	VDE T-socket-wrench 1/2 inch
14-656 VDE	VDE screwdriver slot blade 6.5 x 150 mm	16-505 VDE	VDE single-ended open-end wrench 10.0 mm
14-682 VDE	VDE screwdriver cross-recess PH1 Ø 4.5 mm	16-506 VDE	VDE single-ended open-end wrench 11.0 mm
14-683 VDE	VDE screwdriver cross-recess PH2 Ø 6.0 mm	16-507 VDE	VDE single-ended open-end wrench 12.0 mm
15-521 VDE	VDE cable knife blade length 50mm	16-508 VDE	VDE single-ended open-end wrench 13.0 mm
15-522 VDE	VDE cable dismantling knife with hook blade	16-509 VDE	VDE single-ended open-end wrench 14.0 mm
16-441 VDE	VDE socket 1/2 inch 10.0mm	16-512 VDE	VDE single-ended open-end wrench 17.0 mm
16-442 VDE	VDE socket 1/2 inch 11.0 mm	16-513 VDE	VDE single-ended open-end wrench 19.0 mm
16-443 VDE	VDE socket 1/2 inch 12.0 mm	17-531 VDE	VDE voltage tester Steinel Volt Check 3
16-444 VDE	VDE socket 1/2 inch 13.0 mm		

8160 VDE TOOL SET IN PLASTIC CASE

► 8160 VDE Tool case set 12 pcs (incl. case)

Art.-No.	Content	Art.-No.	Content
8150-10	Plastic case with foam inlay empty	14-654 VDE	VDE screwdriver slot blade 5.5 x 125 mm
13-106 VDE	VDE side cutters 165mm	14-656 VDE	VDE screwdriver slot blade 6.5 x 150 mm
13-207 VDE	VDE telephone pliers 205mm serrated jaws, straight, with wire cutter	14-682 VDE	VDE screwdriver cross-recess PH1 Ø 4.5 mm
13-708 VDE	VDE combination pliers 210mm serrated jaws	14-683 VDE	VDE screwdriver cross-recess PH2 Ø 6.0 mm
13-806 VDE	VDE wire strippers 165mm with stop screw	15-521 VDE	VDE cable knife blade length 50mm
14-651 VDE	VDE screwdriver slot blade 2.5 x 75 mm	15-522 VDE	VDE cable dismantling knife with hook blade
14-652 VDE	VDE screwdriver slot blade 3.5 x 100 mm		



Outer dimensions: 350 x 310 x 110 mm



3900 g



24 tools



8150 VDE TOOL SET



Outer dimensions: 350 x 310 x 110 mm



2800 g



12 tools



8160 VDE TOOL SET



8200 VDE TOOL CASE PROTECTION

A case containing a basic set of common safety tools.

BERNSTEIN safety tools are insulated and individually tested in accordance with VDE regulations IEC 60900 / EN 60900, guaranteeing maximum safety. The two-colour multilayer dip insulated makes any damage to the outer red insulation immediately visible due to the yellow insulation underneath. The advantage is that a simple safety check can be carried out at any time.



► 8200 VDE Tool case 21 pcs

Art.-No.	Content	Art.-No.	Content
5015	Tool case PERFORMANCE 28 empty pockets	15-521 VDE	VDE cable knife blade length 50mm
13-908 VDE	VDE side cutters 180mm	5-505	Stripping knife Ø 4-28mm with hook blade
13-917 VDE	VDE telephone pliers 200 mm serrated jaws, straight, with wire cutter	15-531 VDE	VDE automatic wire stripper (0.2-6.0m ²)
13-937 VDE	VDE combination pliers 185mm with serration	17-523 VDE	VDE plastic clip with internal spiral spring
14-651 VDE	VDE screwdriver slot blade 2.5 x 75 mm	17-541 VDE	VDE metal saw 150mm blade
14-653 VDE	VDE screwdriver slot blade 4.0 x 100 mm	7-116	Engineer's hammer to DIN 1041, 300g
14-654 VDE	VDE screwdriver slot blade 5.5 x 125 mm	7-235	Flat chisel 200 x 14 x 20 mm
14-656 VDE	VDE screwdriver slot blade 6.5 x 150 mm	7-255	Electrician's chisel with safety impact head 200 x 8 x 10 mm
14-682 VDE	VDE screwdriver cross-recess PH1 Ø 4.5 mm	7-405	Painter's spatula 50 mm wide
14-683 VDE	VDE screwdriver cross-recess PH2 Ø 6.0 mm	7-410	Slicker trowel 16 mm wide
14-692 VDE	VDE screwdriver cross-recess PZ1 Ø 4.5 mm		
14-693 VDE	VDE screwdriver cross-recess PZ2 Ø 6.0 mm		

8300 VDE TOOL BACKPACK GLOBETROTTER

NEW

A tool kit containing a basic set of VDE tools for mobile use.

BERNSTEIN safety tools are insulated and individually tested in accordance with VDE regulations IEC 60900 / EN 60900, guaranteeing maximum safety. The multilayer dip insulated makes any damage to the outer red insulation immediately visible due to the yellow insulation underneath. The advantage is that a simple safety check can be carried out at any time.

► 8300 VDE Tool backpack 22

Art.-No.	Content	Art.-No.	Content
8315	Tool backpack 36 empty pockets	14-693 VDE	VDE screwdriver cross-recess PZ2 Ø 6.0 mm
13-106 VDE	VDE side cutters 165mm	15-521 VDE	VDE cable knife blade length 50mm
13-207 VDE	VDE telephone pliers 205mm serrated jaws, straight, with wire cutter	15-522 VDE	VDE cable dismantling knife with hook blade
13-708 VDE	VDE combination pliers 210mm serrated jaws	15-531 VDE	VDE automatic wire stripper (0.2-6.0m ²)
14-651 VDE	VDE screwdriver slot blade 2.5 x 75 mm	16-503 VDE	VDE single-ended open-end wrench 8.0 mm
14-653 VDE	VDE screwdriver slot blade 4.0 x 100 mm	16-504 VDE	VDE single-ended open-end wrench 9.0 mm
14-654 VDE	VDE screwdriver slot blade 5.5 x 125 mm	16-505 VDE	VDE single-ended open-end wrench 10.0 mm
14-656 VDE	VDE screwdriver slot blade 6.5 x 150 mm	16-506 VDE	VDE single-ended open-end wrench 11.0 mm
14-658 VDE	VDE screwdriver slot blade 8.0 x 175 mm	16-507 VDE	VDE single-ended open-end wrench 12.0 mm
14-682 VDE	VDE screwdriver cross-recess PH1 Ø 4.5 mm	16-508 VDE	VDE single-ended open-end wrench 13.0 mm
14-683 VDE	VDE screwdriver cross-recess PH2 Ø 6.0 mm	16-509 VDE	VDE single-ended open-end wrench 14.0 mm
14-692 VDE	VDE screwdriver cross-recess PZ1 Ø 4.5 mm		



► **8200 VDE case**

The compact shape and the textured surface give the case a high degree of stability. The use of X-ABS synthetic with an extremely non-slip and scratch-resistant surface makes the case resistant to external influences. The high-impact and unbreakable material also makes the suitcase „airworthy“ and withstands the harsh handling checked luggage is subjected to. An ergonomic handle, sturdy ratchet hinges with a lid lock, tool panels made of moisture-resistant and shatter-proof ConPearl® plastic with sewn-in pockets, two locks and an adaptable bottom shell (height 60 mm) add the finishing touches to this case.



► **8300 VDE backpack**

The multifunctional tool backpack made from heavy duty and water-proof black nylon and contrasting white seams offers enough space for your tools with 26 pockets and 37 rubber loops. Thanks to its size-adjustable straps and padded breathable back part, it guarantees excellent carrying comfort – even with very heavy contents. The backpack as a total of three large compartments, each fitted with a high-quality and smooth zip. All the compartments have enough padding to also allow you to carry a tablet or 15" notebook. The detachable front pad is especially nifty and can be used as a knee protector when working on the floor. A ergonomic and very flexible carrying handle, as well as sturdy rubber feet to protect from water-logging add the finishing touches to this very modern-looking and functional backpack.

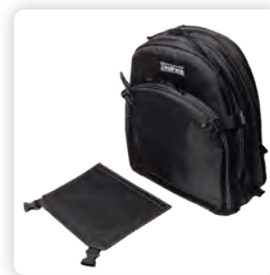

Outer dimensions: 480 x 350 x 170 mm (closed)



Without tools: 3900 g
With tools: 7100 g



21 tools



8200 VDE PROTECTION with tools
5015 PERFORMANCE without tools



Outer dimensions: 350 x 430 x 230 mm (closed)



Without tools: 2000 g
With tools: 4000



22 tools



8300 VDE GLOBETROTTER with tools
8315 VDE GLOBETROTTER without tools

VDE PLIERS WITH TWO-COLOUR MULTILAYER SAFETY INSULATION

Pliers made from special tool steel, oil-hardened, chrome-plated with two-colour multilayer dipped insulated, outer red, inner yellow. Damage to the outer red insulation is immediately visible due to the yellow insulation. The advantage is that a simple safety check can be carried out at any time.

Insulated in accordance with VDE regulations IEC 60900/EN 60900, individually tested, permitted voltage, with which insulated pliers can be used:
1000 V AC voltage or 1500 V DC voltage.



The following types are available, specifications in mm:

Art.-No.	Short description	Type	Cutting values	DIN ISO	Total length	Weight in g	1000 V
13-106 VDE	VDE side cutters	Cutting edges inductively hardened	Steel wire up to Ø 2.0 mm	DIN ISO 5749	165	210	
13-207 VDE	VDE telephone pliers	serrated jaws	Steel wire up to Ø 2.5 mm	DIN ISO 5749	205	240	
13-208 VDE	VDE telephone pliers	serrated jaws	Steel wire up to Ø 2.5 mm	DIN ISO 5749	200	250	
13-708 VDE	VDE combination pliers	serrated jaws	Steel wire up to Ø 2.8 mm	DIN ISO 5746	205	390	
13-806 VDE	VDE wire strippers	with stop screw	-	DIN ISO 5743	170	200	

VDE TWEEZERS

p. 56 Tweezers

VDE PLIERS WITH ONE-COMPONENT PLASTIC HANDLE

Pliers made from special tool steel for hard and soft wires, chrome-plated with one-component plastic grips that are non-slip.

Insulated in accordance with VDE regulations IEC 60900/EN 60900, individually tested, permitted voltage, under which insulated pliers can be used.
1000 V AC voltage or 1500 V DC voltage.



The following types are available, specifications in mm:

Art.-No.	Short description	Type	Cutting values	DIN ISO	Total length	Weight in g	1000 V
13-906 VDE	VDE side cutters	Cutting edges inductively hardened	Steel wire up to Ø 2.0 mm	DIN ISO 5749 (5238B)	165	210	
13-908 VDE	VDE side cutters	Cutting edges inductively hardened	Steel wire up to Ø 2.5 mm	DIN ISO 5749 (5238B)	180	290	
13-915 VDE	VDE telephone pliers	serrated jaws, wire cutter	Steel wire up to Ø 2.0 mm	DIN ISO 5745 (5236A)	160	150	
13-916 VDE	VDE telephone pliers	serrated jaws, wire cutter	Steel wire up to Ø 2.0 mm	DIN ISO 5745 (5236A)	165	150	
13-917 VDE	VDE telephone pliers	serrated jaws, wire cutter	Steel wire up to Ø 2.5 mm	DIN ISO 5745 (5236A)	205	220	
13-918 VDE	VDE telephone pliers	serrated jaws, wire cutter	Steel wire up to Ø 2.5 mm	DIN ISO 5745 (5236A)	200	220	
13-926 VDE	VDE round nose pliers	serrated jaws	-	DIN ISO 5745 (5249A)	165	165	
13-927 VDE	VDE flat nose pliers	serrated jaws	-	DIN ISO 5745 (52489)	170	175	
13-936 VDE	VDE combination pliers	serrated jaws	Steel wire up to Ø 2.0 mm	DIN ISO 5746 (5244)	170	220	
13-937 VDE	VDE combination pliers	serrated jaws	Steel wire up to Ø 2.3 mm	DIN ISO 5746 (5244)	190	280	
13-938 VDE	VDE combination pliers	serrated jaws	Steel wire up to Ø 2.8 mm	DIN ISO 5746 (5244)	210	350	
13-946 VDE	VDE wire strippers	with stop screw	-	DIN ISO 5743	170	190	

MULTIFUNCTIONAL PLIERS

Multifunctional power-combination pliers for cutting hard and soft wires as well as stranded copper conductors and aluminium conductors. The pliers are forged from quality tool steel and oil hardened. The cutters are inductively hardened and the surface matt polished.

Insulated in accordance with VDE regulations IEC 60900/EN 60900, individually tested, permitted voltage, with which insulated pliers can be used: 1000 V AC voltage or 1500 V DC voltage.

► **VDE combination pliers**

NEW

- 45° angled handle for ergonomic working
- Gripping surfaces, serrated for firm hold on workpiece
- With opening spring and safety lock
- Integrated ring spanner up to WAF 18

The following types are available, specifications in mm:

Art.-No.	Handle type	Type	Total length	Weight in g	1000 V
13-704 VDE	two-colour dip insulated	up to Ø 2.5 / 5.9 / 13 mm	200	320	⚡
13-934 VDE	one-component plastic handle	up to Ø 2.5 / 5.9 / 13 mm	200	310	⚡



13-704 VDE

► **VDE combination pliers**

NEW

- 45° angled handle for ergonomic working with stripping function for wires from 1.5 mm² - 2.5 mm² conductor cross-section
- Gripping surfaces, serrated for firm hold on workpiece
- With opening spring and safety lock
- Integrated ring spanner up to WAF 18

The following types are available, specifications in mm:

Art.-No.	Handle type	Type	Total length	Weight in g	1000 V
13-705 VDE	two-colour dip insulated	up to Ø 2.5 / 5.9 / 13 mm	200	325	⚡
13-935 VDE	one-component plastic handle	up to Ø 2.5 / 5.9 / 13 mm	200	315	⚡



13-705 VDE

CABLE CUTTERS

▶ VDE cable cutter with stripping function

NEW

For NYM cables 3 x 1.5 mm² to 5 x 2.5 mm², low-deformation cut,
Universal stripping opening for both cross-sections, short overall length and opening
spring mechanism for fast and convenient working, safety lock,
Partially burnished surface, adjustable joint
Material tool steel



15-902 VDE

Art.-No.	Handle type	Type	Total length	Weight in g	1000 V
15-502 VDE	two-colour dip insulated	up to Ø 12 mm / 35 mm ²	170	260	⚡
15-902 VDE	one-component plastic handle	up to Ø 12 mm / 35 mm ²	170	260	⚡

▶ VDE cable cutter, 2 cut

NEW

With 2 cutting edges for a flush cut without crushing.
Surface matt polished
Material tool steel



15-503 VDE

Art.-No.	Handle type	Type	Total length	Weight in g	1000 V
15-503 VDE	two-colour dip insulated	up to Ø 10 mm / 25 mm ²	160	216	⚡
15-903 VDE	one-component plastic handle	up to Ø 10 mm / 25 mm ²	160	216	⚡

▶ VDE cable cutter, double cut

NEW

With 2 cutting edges for a flush cut without crushing.
Surface matt polished, adjustment joint
Material tool steel



15-504 VDE



Art.-No.	Handle type	Type	Total length	Weight in g	1000 V
15-504 VDE	two-colour dip insulated	up to Ø 20 mm / 60 mm ²	210	362	⚡
15-904 VDE	one-component plastic handle	up to Ø 20 mm / 60 mm ²	210	362	⚡

▶ Cable cutter

for copper and aluminium cables, two-colour multilayer immersion insulation, adjustment joint
Material tool steel



15-501 VDE

Art.-No.	Handle type	Type	Total length	Weight in g	1000 V
15-501 VDE	two-colour dip insulated	up to Ø 20 mm / 60 mm ²	210	360	⚡  

▶ Ratchet cable cutter

for easier cutting of large cross-sections, for copper and aluminium cables, not for armoured cables.



15-506 VDE

Art.-No.	Handle type	Type	Total length	Weight in g	1000 V
15-506 VDE	two-colour dip insulated	up to Ø 32 mm / 240 mm ²	250	800	⚡

VDE SCREWDRIVERS

and / or

► VDE Screwdrivers

BERNSTEIN VDE screwdrivers are under the control of the VDE test centre. Each screwdriver in this series is individually tested in accordance with VDE guidelines DIN IEC 60900 / EN 60900, IEC 900. The test guarantees the highest level of safety for all work up to 1000 V.w

Blade: hardened over the entire length, burnished with protective coating
 Handle: impact-resistant, two-colour multi-component insulation, with anti-slip protection and practical suspension hole



The following types are available, specifications in mm:

Art.-No.	Symbol	Size / drive	Blade length	Blade width	Blade thickness	Blade diameter	Handle length	Total length	Weight in g
14-651 VDE	⊖	Slot	75	2.5	0.4	-	100 x 21	175	26
14-652 VDE	⊖	Slot	100	3.5	0.6	-	100 x 21	200	34
14-653 VDE	⊖	Slot	100	4	0.8	-	100 x 21	200	37
14-654 VDE	⊖	Slot	125	5.5	1	-	107 x 27	232	75
14-656 VDE	⊖	Slot	150	6.5	1.2	-	114 x 32	264	112
14-658 VDE	⊖	Slot	175	8	1.2	-	121 x 35	296	175
14-681 VDE	⊕	PH0	60	-	-	3	100 x 21	160	27
14-682 VDE	⊕	PH1	80	-	-	4.5	107 x 27	187	57
14-683 VDE	⊕	PH2	100	-	-	6	114 x 32	214	92
14-684 VDE	⊕	PH3	150	-	-	8	121 x 35	271	166
NEW 14-685 VDE	⊕	PH/S1	80	-	-	4.5	107 x 27	187	57
NEW 14-686 VDE	⊕	PH/S2	100	-	-	6	114 x 32	214	92
14-692 VDE	⊗	PZ1	80	-	-	4.5	107 x 27	187	57
14-693 VDE	⊗	PZ2	100	-	-	6	114 x 32	214	92
14-694 VDE	⊗	PZ3	150	-	-	8	121 x 35	271	166
NEW 14-695 VDE	⊗	PZ/S1	80	-	-	4.5	107 x 27	187	57
NEW 14-696 VDE	⊗	PZ/S2	100	-	-	6	114 x 32	214	92
16-298 VDE	⊙	PZ3	125	-	-	-	100 x 21	225	40
16-299 VDE	⊙	4	125	-	-	-	100 x 21	225	45
16-301 VDE	⊙	5	125	-	-	-	100 x 21	225	55
16-302 VDE	⊙	5.5	125	-	-	-	107 x 27	232	85

► 14-650 VDE

VDE screwdriver set 7 pcs

Weight: 450 g

Art.-No.	Content
14-651 VDE	⊖ VDE screwdriver slot blade 2.5 x 75 mm
14-652 VDE	⊖ VDE screwdriver slot blade 3.5 x 100 mm
14-654 VDE	⊖ VDE screwdriver slot blade 5.5 x 125 mm
14-656 VDE	⊖ VDE screwdriver slot blade 6.5 x 150 mm
14-681 VDE	⊕ VDE screwdriver cross-recess PH0 Ø 3.0 mm
14-682 VDE	⊕ VDE screwdriver cross-recess PH1 Ø 4.5 mm
4-343 VDE	⊖ VDE voltage tester slot blade 3.0 x 0.7 x 60 mm

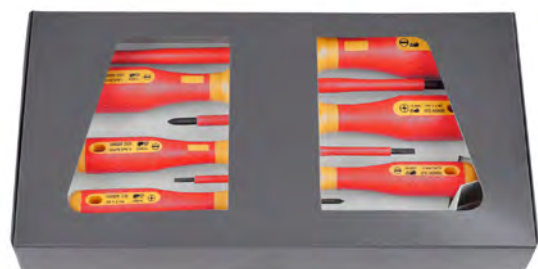

14-650 VDE

VDE WRENCHES AND SOCKETS



▶ VDE open-end wrench

Chrome vanadium, chrome-plated, according to DIN 7446, jaw position 15°
Two-colour multilayer dip insulation, 1000 V

Art.-No.	WAF	Weight in g		1000 V
16-501 VDE	6	24	△	
16-502 VDE	7	25	△	
16-503 VDE	8	26	△	
16-504 VDE	9	38	△	
16-505 VDE	10	42	△	GS D'E
16-506 VDE	11	48	△	GS D'E
16-507 VDE	12	58	△	GS D'E
16-508 VDE	13	68	△	GS D'E
16-509 VDE	14	75	△	GS D'E
16-511 VDE	15	88	△	GS D'E
16-512 VDE	17	120	△	GS D'E
16-513 VDE	19	160	△	GS D'E
16-514 VDE	21	210	△	GS D'E
16-515 VDE	24	300	△	GS D'E
16-517 VDE	26	340	△	



▶ VDE single-ended ring wrench

Chrome vanadium, chrome-plated, according to DIN 7447,
Two-colour multilayer dip insulation, 1000 V

Art.-No.	WAF	Weight in g		1000 V
16-531 VDE	6	50	△	
16-533 VDE	8	65	△	
16-535 VDE	10	80	△	GS B'V
16-536 VDE	11	100	△	GS B'V
16-537 VDE	12	110	△	GS B'V
16-538 VDE	13	120	△	GS B'V
16-539 VDE	14	150	△	GS B'V
16-541 VDE	15	155	△	GS B'V
16-542 VDE	16	170	△	GS B'V
16-543 VDE	17	180	△	GS B'V
16-544 VDE	18	240	△	GS B'V
16-545 VDE	19	245	△	GS B'V
16-547 VDE	21	317	△	GS B'V
16-548 VDE	22	353	△	GS B'V
16-551 VDE	24	357	△	GS B'V



▶ VDE sockets

Chrome vanadium, chrome-plated, according to DIN 7448 qjth square drive,
Two-colour multilayer dip insulation

Art.-No.	Inch	WAF	Weight in g		1000 V
16-441 VDE	1/2	10	60	△	GS D'E
16-442 VDE	1/2	11	63	△	GS D'E
16-443 VDE	1/2	12	64	△	GS D'E
16-444 VDE	1/2	13	64	△	GS D'E
16-445 VDE	1/2	14	67	△	GS D'E
16-446 VDE	1/2	15	68	△	GS D'E
16-447 VDE	1/2	17	74	△	GS D'E
16-448 VDE	1/2	19	83	△	GS D'E
16-449 VDE	1/2	22	114	△	GS D'E
16-451 VDE	1/2	24	117	△	GS D'E
16-452 VDE	1/2	27	181	△	
16-453 VDE	1/2	30	195	△	
16-454 VDE	1/2	32	200	△	
16-481 VDE	3/8	6	23	△	
16-482 VDE	3/8	7	28	△	
16-483 VDE	3/8	8	29	△	GS D'E
16-484 VDE	3/8	9	31	△	GS D'E
16-485 VDE	3/8	10	31	△	GS D'E
16-486 VDE	3/8	11	33	△	GS D'E
16-487 VDE	3/8	12	33	△	GS D'E
16-488 VDE	3/8	13	34	△	GS D'E
16-489 VDE	3/8	14	36	△	GS D'E
16-491 VDE	3/8	15	44	△	GS D'E
16-492 VDE	3/8	16	50	△	GS D'E
16-493 VDE	3/8	17	54	△	GS D'E
16-494 VDE	3/8	19	58	△	
16-495 VDE	3/8	19	70	△	
16-496 VDE	3/8	20	72	△	
16-497 VDE	3/8	21	77	△	
16-498 VDE	3/8	22	94	△	

▶ VDE reversible ratchet

According to DIN 7449, two-colour multilayer dip insulation
Hold or release the inserts at the push of a button; right/left by turning the lever.



16-471 VDE

Art.-No.	Type	Total length	Weight in g	1000 V
16-471 VDE	1/2" square drive	260	668	△ GS D'E
16-472 VDE	3/8" square drive	200	356	△ GS D'E

▶ Extension

DIN 7434, two-colour multilayer dip insulation
Cannulated, locking with screw, with locking device



16-476 VDE

Art.-No.	Type	Total length	Weight in g	1000 V
16-476 VDE	1/2" square drive	125	206	△ GS D'E
16-478 VDE	3/8" square drive	125	154	△ GS D'E

- other dimensions on request -
(minimum purchase 5 pieces)

VDE TOOLS

▶ Adjustable spanner

According to DIN 3117, IEC 60900:2004, two-colour multilayer dip insulation, 1000 V, jaw position 15°, with scale graduation

Art.-No.	Width across flats	Weight in g	1000 V
16-773 VDE	0-26	300	⚡
16-774 VDE	0-30	500	⚡
16-775 VDE	0-35	800	⚡



▶ Insulating protective gloves

for work under voltage up to 1000 Volt, made of natural latex high elasticity piece tested according to DIN EN 60903, VDE 0682-part 311, test voltage 5000 Volt

Art.-No.	Type	Thickness	Length	Weight in g	1000 V
17-501 VDE	Größe 10	1.0 mm	360 ± 15 mm	175	KL. 0



17-501 VDE

▶ NH plug-in-grip

with leather cuff 380 x 220 mm for inserting or removing NH fuse links

Art.-No.	Type	Weight in g	1000 V
17-521 VDE	Siemens-handle for NH fuses 00-3, protection of forearm at higher currents (arc fault due to system)	450	⚡



17-521 VDE

▶ Rubber cover, red

DIN EN 61112 / VDE 0682-511, smooth surface, for work on electrical installations

Art.-No.	Type	Thickness	Weight in g	1000 V
17-702 VDE	500 x 500 mm	1.6 mm	590	⚡
17-703 VDE	1000 x 1000 mm	1.6 mm	1936	⚡



17-703 VDE

▶ VDE rubber mat / floor mat, grey

Surface one side smooth and one side slip-resistant, frost-resistant, according to REACH, free of nitrosamine and PAH.

For the removal and installation of site insulation in electrical systems.

Not for mobile use as PSA accessory!

Art.-No.	Type	Weight in g	1000 V
17-707 VDE	1000 x 1000 x 4,5 mm DIN VDE 0303	5400	-

To be used for mobile site insulation according to BGR A3!

Not to be used as flooring material!

Art.-No.	Type	Weight in g	1000 V
17-706 VDE	1500 x 1000 x 3,0 mm DIN 6111 / VDE 0680	4850	⚡



17-706 VDE

NEW

▶ Plastic clip

for fixing cover cloths, made of sturdy plastic with concealed spring and rubber web to prevent slipping

Art.-No.	Type	Length	Weight in g	1000 V
17-523 VDE	Clamping width 15 mm, opening width 40 mm	160 mm	60	⚡



17-523 VDE

▶ Self-clamping sleeves

Protect against contact with a live cable end

Art.-No.	Type	Weight in g	1000 V
17-551 VDE	Ø 10 x 80 mm	20	⚡
17-552 VDE	Ø 20 x 85 mm	30	⚡
17-553 VDE	Ø 30 x 100 mm	60	⚡



17-552 VDE

VOLTAGE TESTER

► 17-531 VDE

VDE voltage tester Steinel Volt Check 3

DIN EN 61243-3, DIN CDE 0682, Teil 401, IEC 61010

This voltage tester can be used universally and is built according to the latest safety regulations and guarantees safe and reliable operation. The voltage tester features the following functions: Voltage testing up to 690 V AC/DC phase - phase, automatic AC/DC detection, bright LED display, robust, ergonomically shaped housing for good handling, captive measuring tip shoe.

Weight: 110 g



17-531 VDE

► 4-344 VDE

VDE voltage tester slot blade 3.5 x 0.7 x 110 mm

VDE voltage tester 220 - 250 V, according to DIN VDE 0680 part 6: 1977-04.

Blade: chrome vanadium, nickel-plated, fully insulated, handle: transparent plastic.

Length: 196 mm, weight: 31 g



4-344 VDE

► 4-343 VDE

VDE voltage tester slot blade 3.0 x 0.7 x 60 mm

VDE voltage tester 220 - 250 V, according to DIN VDE 0680 part 6: 1977-04.

Blade: chrome vanadium, nickel-plated, fully insulated, handle: transparent plastic.

Length: 136 mm, weight: 20 g



4-343 VDE

VDE CABLE CUTTING TOOLS

► Cable knives, dismantling knives

Stainless steel blade, with protective blade cap, impact-resistant plastic handle

Art.-No.	Type	Blade length	Total length	Weight in g	1000 V
15-521 VDE	Straight blade	50 mm	180	66	
15-522 VDE	Hook blade	35 mm	180	66	
15-523 VDE	Special blade + slide foot	35 mm	180	73	



15-521 VDE



15-522 VDE



15-523 VDE

► Automatic wire stripper with stop screw

For common flexible and solid conductors (von 0,2 - 6,0 mm²)

Adjustable, removable length stop from 5 - 12 mm

Art.-No.	Type	Total length	Weight in g	1000 V
15-531 VDE	glass fibre reinforced plastic, fully insulated	200	110	



15-531 VDE

► Metal saw bow

Strong die-cast aluminium frame, two-colour multilayer dip insulation

Art.-No.	Type	Total length	Weight in g	1000 V
17-541 VDE	Saw blade (150 mm) interchangeable	270	180	
17-547 VDE	Saw blade (300 mm) interchangeable hardened teeth	460	580	



17-541VDE

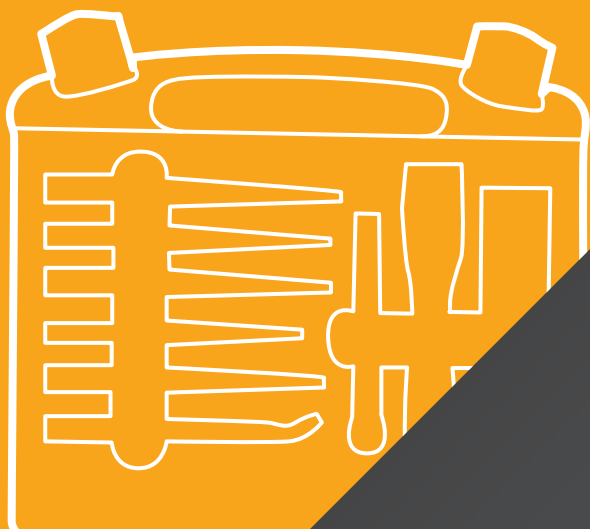
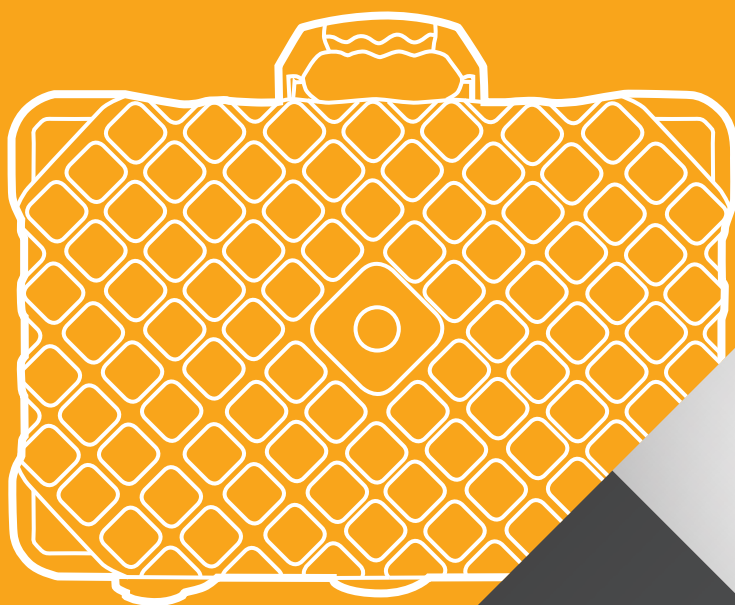
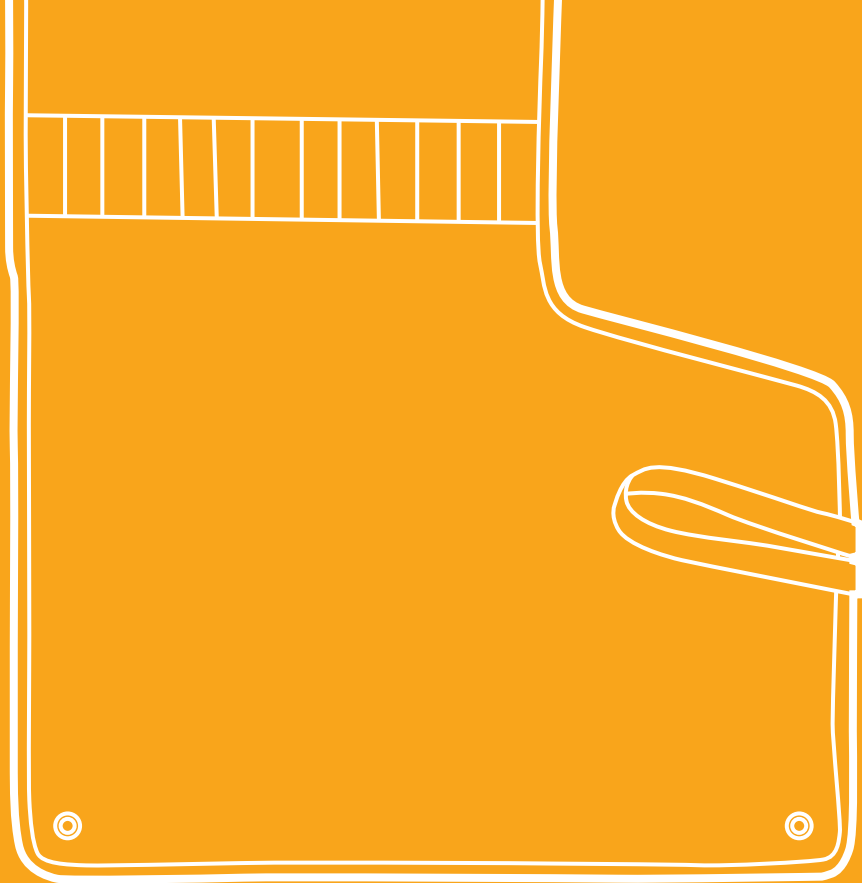

CASES AND SETS – MORE SKILLS INSIDE OUR TOOLCASES!

More than 50 years of practical experience in designing and equipping service cases and service sets can be found once again in our series of cases. The case housing and tool panels are characterised by a particularly high degree of stability and an unmistakable BERNSTEIN design.

With a practical selection of high-grade quality and special tools, the range is equipped for many different applications.

ESD TOOL SET

ESD tools for various jobs in ESD areas. The tools are stored in handy ESD-conductive plastic cases and clearly arranged in customised recesses made from conductive rigid foam. For the assembly of circuit boards and working on electronic assemblies in accordance with DIN EN 61340-5-1.

The five tweezers allow for precise gripping, inserting and desoldering of small electronic components. They are equipped with level, smooth and bent gripping surfaces.

The pliers feature a particularly narrow and pointed head for precise snipping of soft and semi-hard wires.

2210 ESD tool set PRECISE 6 pcs

Art.-No.	Content
2211	ESD conductive synthetic case with foam insert empty
3-653-15	ESD mini side cutters EUROline flush 120 mm
5-055-13	ESD SMD tweezers 120 mm form 7a stainless steel angle 40° dissipative
5-062-13	ESD SMD tweezers 115 mm form 59 stainless steel, dissipative
5-065-13	ESD SMD tweezers 120 mm form 50 stainless steel dissipative
5-066-13	ESD SMD tweezers 120 mm form 8b stainless steel, dissipative
5-068-13	ESD tweezers 120 mm form 13 stainless steel, dissipative



2210

2212 ESD tool set PRECISE C 6 pcs

Art.-No.	Content
2211	ESD conductive synthetic case with foam insert empty
3-602-15	ESD side cutters CLASSICline flush 115 mm
5-055-13	ESD SMD tweezers 120 mm form 7a stainless steel angle 40° dissipative
5-062-13	ESD SMD tweezers 115 mm form 59 stainless steel, dissipative
5-065-13	ESD SMD tweezers 120 mm form 50 stainless steel dissipative
5-066-13	ESD SMD tweezers 120 mm form 8b stainless steel, dissipative
5-068-13	ESD tweezers 120 mm form 13 stainless steel, dissipative



2212



Outer dimensions (closed):
178 x 160 x 42 mm



390 g



6 tools



2210 ESD tool set PRECISE
2212 ESD tool set PRECISE C

ELECTRONIC TOOL SET

Elegant zip bag made of black, dissipative synthetic leather, also with dissipative pockets for 13 ESD tools and a foldable ESD work mat with accessories.

EPA suitable for electrostatically protected areas (ESD workplaces/ESD protected zones). The perfect companion for repairing and servicing electrostatically sensitive components. The workplace pad made from soft ESD material offers the option to even work safely while out and about. A large number of different screwdrivers and pliers means that the user is prepared for every situation.



2220

► 2220 ESD tool set ANTISTATIC 17 pcs

Art.-Nr.	Content
2221	ESD dissipative zipper bag 14 empty pockets
2-620	PLCC-extractor
3-601-15	ESD side cutters CLASSICline semi flush 115 mm
3-632-15	ESD flat nose pliers CLASSICline not serrated jaws 120 mm
3-633-15	ESD snipe nose pliers CLASSICline not serrated jaws 120 mm
4-603	ESD screwdriver slot blade 1.5 x 0.25 x 40 mm
4-605	ESD screwdriver slot blade 2.0 x 0.40 x 40 mm
4-606	ESD screwdriver slot blade 2.5 x 0.4 x 50 mm
4-621	ESD screwdriver cross-recess PH000
4-622	ESD screwdriver cross-recess PH00
4-623	ESD screwdriver cross-recess PH0
5-191	ESD plastic tweezers 120 mm form 2a tips 2 mm wide
5-192	ESD plastic tweezers 120 mm form F tips 3 mm wide
9-354-100	ESD table mat 500 x 400 x 0,5 mm
9-342-1	ESD contact bracelet*
9-342-2	ESD spiral cord for bracelet 2.5 m*
9-343-1	ESD grounding cable 1 MOhms, 1500 mm 2 press-studs 10/10 mm
9-353	ESD crocodile clip

*LGA tested BGI 818 (ZH1/267). Therefore fulfilling safety-related requirements for wrist ground in accordance with BGFE (German employers' liability insurance association for precision mechanics and electrical engineering).



Outer dimensions (closed):
320 x 250 x 50 mm



without tools: 520 g
with tools: 1050 g



17 tools



2220 ESD tool set ANTISTATIC with tools
2221 ESD tool set ANTISTATIC without tools

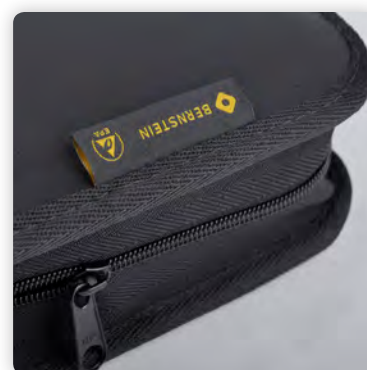

ESD TOOL SETS

► 2230 ESD tool set ELITE 20 pcs

Art.-No.	Content
2231	ESD conductive synthetic case with foam insert empty
3-651-15	ESD mini side cutters EUROline flush 120 mm
3-672-15	ESD end cutters EUROline flush 130 mm
3-682-15	ESD flat nose pliers EUROline not serrated jaws 130 mm
3-683-15	ESD snipe nose pliers EUROline not serrated jaws 130 mm
4-901	ESD interchangeable handle
4-905	interchangeable blades slot 1.5 / 3.0 mm
4-906	interchangeable blades slot 2.0 / 3.5 mm
4-907	interchangeable blades slot 2.5 / 4.0 mm
4-911	interchangeable blades PH00/PH000
4-912	interchangeable blades PH0/PH1
4-921	interchangeable blades TORX T5/T6
4-922 L	interchangeable blades TORX T7/T8
4-923 L	interchangeable blades TORX T9/T10
5-049-13	ESD SMD tweezers 110 mm form 4 stainless steel dissipative
5-055-13	ESD SMD tweezers 120 mm form 7a stainless steel angle 40° dissipative
5-059-13	ESD SMD tweezers 120 mm form 2a stainless steel dissipative
5-067-13	ESD SMD tweezers 120 mm form 12 stainless steel, dissipative
5-068-13	ESD tweezers 120 mm form 13 stainless steel, dissipative
5-078-13	ESD SMD universal tweezers 130 mm stainless steel dissipative
7-422	ESD brush bristles width 20 mm



2230



Outer dimensions (closed):
250 x 210 x 60 mm



850 g



20 tools



2230 ESD tool set ELITE

ESD tools for various jobs in ESD areas. The tools are stored in handy ESD-safe plastic cases and clearly arranged in customised recesses made from conductive rigid foam.

ESD tool set for working on electronic assemblies and equipment in accordance with DIN EN 61340-5-1. The five tweezers allow for precise gripping, inserting and holding of small electronic components. They are equipped with level, smooth and bent gripping surfaces. The pliers have particularly narrow and pointed heads for precise work in tight places. The side cutters are suitable for the precise snipping of soft and semi-hard wires. The quality interchangeable blades (HRC 56-58) are easy to clamp in a dissipative ESD interchangeable grip. The dissipative brush is used to clean statically sensitive components.

ESD TOOL SETS

► 2240 ESD tool set ELITE C 20 pcs

Art.-No.	Content
2231	ESD conductive synthetic case with foam insert empty
3-604-15	ESD side cutters CLASSICline flush 115 mm
3-606-15	ESD side cutters CLASSICline flush 120 mm
3-632-15	ESD flat nose pliers CLASSICline not serrated jaws 120 mm
3-633-15	ESD snipe nose pliers CLASSICline not serrated jaws 120 mm
4-901	ESD interchangeable handle
4-905	interchangeable blades slot 1.5/3.0 mm
4-906	interchangeable blades slot 2.0/3.5 mm
4-907	interchangeable blades slot 2.5/4.0 mm
4-911	interchangeable blades PH00/PH000
4-912	interchangeable blades PH0/PH1
4-921	interchangeable blades TORX T5/T6
4-922 L	interchangeable blades TORX T7/T8
4-923 L	interchangeable blades TORX T9/T10
5-049-13	ESD SMD tweezers 110 mm form 4 stainless steel dissipative
5-055-13	ESD SMD tweezers 120 mm form 7a stainless steel angle 40° dissipative
5-059-13	ESD SMD tweezers 120 mm form 2a stainless steel dissipative
5-067-13	ESD SMD tweezers 120 mm form 12 stainless steel, dissipative
5-068-13	ESD tweezers 120 mm form 13 stainless steel, dissipative
5-078-13	ESD SMD universal tweezers 130 mm stainless steel dissipative
7-422	ESD brush bristles width 20 mm



2240



Outer dimensions (closed):
250 x 210 x 60 mm



850 g



20 tools



2240 ESD tool set ELITE C

ESD tools for various jobs in ESD areas. The tools are stored in handy ESD-safe plastic cases and clearly arranged in customised recesses made from conductive rigid foam.

ESD tool set for working on electronic assemblies and equipment in accordance with DIN EN 61340-5-1. The five tweezers allow for precise gripping, inserting and holding of small electronic components. They are equipped with level, smooth and bent gripping surfaces. The pliers have particularly narrow and pointed heads for precise work in tight places. The side cutters are suitable for the precise snipping of soft and semi-hard wires. The quality interchangeable blades (HRC 56-58) are easy to clamp in a dissipative ESD interchangeable grip. The dissipative brush is used to clean statically sensitive components.

ELECTRONIC TOOL SETS

Special service sets for servicing and repairing mobile telephone devices and other highly sensitive electronic components. The tools are packed in a handy zip case made from black dissipative synthetic leather.

► 2250 ESD tool set CARAT 9 pcs

Art.-No.	Content
2251	ESD dissipative zipper bag 9 empty pockets
3-672-15	ESD end cutters EUROline flush 130 mm
3-683-15	ESD snipe nose pliers EUROline not serrated jaws 130 mm
4-603	ESD screwdriver slot blade 1.5 x 0.25 x 40 mm
4-605	ESD screwdriver slot blade 2.0 x 0.40 x 40 mm
4-621	ESD screwdriver cross-recess PH000
4-623	ESD screwdriver cross-recess PH0
5-191	ESD plastic tweezers 120 mm form 2a tips 2 mm wide
6-661	ESD torx screwdriver T5
6-663 L	ESD torx screwdriver T7



2250

► 2252 ESD tool set CARAT C 9 pcs

Art.-No.	Content
2251	ESD dissipative zipper bag 9 empty pockets
3-606-15	ESD side cutters CLASSICline flush 120 mm
3-633-15	ESD snipe nose pliers CLASSICline not serrated jaws 120 mm
4-603	ESD screwdriver slot blade 2.0 x 0.40 x 40 mm
4-605	ESD screwdriver slot blade 1.5 x 0.25 x 40 mm
4-621	ESD screwdriver cross-recess PH000
4-623	ESD screwdriver cross-recess PH0
5-191	ESD plastic tweezers 120 mm form 2a tips 2 mm wide
6-661	ESD torx screwdriver T5
6-663 L	ESD torx screwdriver T7



2252

► 2270 ESD tool set ACCENT 9 pcs

Art.-No.	Content
2251	ESD dissipative zipper bag 9 empty pockets
3-601-15	ESD side cutters CLASSICline semi flush 115 mm
3-633-15	ESD snipe nose pliers CLASSICline not serrated jaws 120 mm
4-603	ESD screwdriver slot blade 1.5 x 0.25 x 40 mm
4-605	ESD screwdriver slot blade 2.0 x 0.40 x 40 mm
4-621	ESD screwdriver cross-recess PH000
4-623	ESD screwdriver cross-recess PH0
5-191	ESD plastic tweezers 120 mm form 2a tips 2 mm wide
6-661	ESD torx screwdriver T5
6-663 L	ESD torx screwdriver T7



2270

Outer dimensions (closed):
190 x 135 x 35 mm



360 g



9 tools



ESD tool set CARAT **2250**
ESD tool set CARAT C **2252**
ESD tool set ACCENT **2270**





BERNSTEIN
TOOLS FOR ELECTRONICS

NEW

1,2,3,4...
GOOD REASONS
TO GO BACK!

All information about our new
SPANNFIX 4.0 – THE NEXT GENERATION
are on the pages 16-17.



ESD PROFI SET

Selected ESD tools in a handy plastic case made from a conductive material. The tools are clearly arranged in customised recesses made from conductive rigid foam. One or two compartments are empty for individual needs.

EPA suitable for electrostatically protected areas (ESD workplaces/ESD protected zones). Professional tool set for repairing and servicing complex electronic components and assemblies.

► **2280 ESD tool set TRENDY 23 pcs**

► **2285 ESD tool set TRENDY 18 pcs (without ESD handling set)**

Art.-No.	Content
2281	ESD conductive synthetic case with foam insert empty
2-620	PLCC-extractor
3-133-13	ESD side cutters 145 mm dissipative
3-651-15	ESD mini side cutters EUROline flush 120 mm
3-682-15	ESD flat nose pliers EUROline not serrated jaws 130 mm
3-683-15	ESD snipe nose pliers EUROline not serrated jaws 130 mm
4-603	ESD screwdriver slot blade 1.5 x 0.25 x 40 mm
4-605	ESD screwdriver slot blade 2.0 x 0.40 x 40 mm
4-606	ESD screwdriver slot blade 2.5 x 0.4 x 50 mm
4-621	ESD screwdriver cross-recess PH000
4-622	ESD screwdriver cross-recess PH00
4-623	ESD screwdriver cross-recess PH0
5-049-13	ESD SMD tweezers 110 mm form 4 stainless steel dissipative
5-055-13	ESD SMD tweezers 120 mm form 7a stainless steel angle 40° dissipative
5-059-13	ESD SMD tweezers 120 mm form 2a stainless steel dissipative
6-661	ESD torx screwdriver T5
6-662	ESD torx screwdriver T6
6-663 L	ESD torx screwdriver T7
7-422	ESD brush bristles width 20mm
9-354-100	ESD table mat 500 x 400 x 0.5 mm
9-342-1	ESD contact bracelet blue
9-342-2	ESD spiral cord for bracelet 2.5 m black
9-343-1	ESD grounding cable 1 MOhms, 1500 mm 2 press-studs 10/10mm
9-353	ESD crocodile clip



2280

handling set

► **9-354 ESD handling set 5 pcs**

Art.-No.	Content
9-354-100	ESD table mat 500 x 400 x 0.5 mm
9-342-1	ESD contact bracelet blue
9-342-2	ESD spiral cord for bracelet 2.5 m black
9-343-1	ESD grounding cable 1 MOhms, 1500mm 2 press-studs 10/10 mm
9-353	ESD crocodile clip

Outer dimensions (closed):
350 x 310 x 65 mm



2280: 1500 g
2285: 1250 g



2280: 23 tools
2285: 18 tools



ESD tool set TRENDY **2280**
ESD tool set TRENDY **2285**



ESD PROFI SET

Selected ESD tools in a handy plastic case made from a conductive material. The tools are clearly arranged in customised recesses made from conductive rigid foam. One or two compartments are empty for individual needs.

EPA suitable for electrostatically protected areas (ESD workplaces/ESD protected zones). Professional tool set for repairing and servicing complex electronic components and assemblies.

► 2282 ESD tool set TRENDY C 23 pcs

► 2286 ESD tool set TRENDY C 18 set (without ESD handling set)

Art.-No.	Content
2281	ESD conductive synthetic case with foam insert empty
2-620	PLCC-extractor
3-133-13	ESD side cutters 145 mm dissipative
3-602-15	ESD side cutters CLASSICline flush 115 mm
3-632-15	ESD flat nose pliers CLASSICline not serrated jaws 120 mm
3-633-15	ESD snipe nose pliers CLASSICline not serrated jaws 120 mm
4-603	ESD screwdriver slot blade 1.5 x 0.25 x 40 mm
4-605	ESD screwdriver slot blade 2.0 x 0.40 x 40 mm
4-606	ESD screwdriver slot blade 2.5 x 0.4 x 50 mm
4-621	ESD screwdriver cross-recess PH000
4-622	ESD screwdriver cross-recess PH00
4-623	ESD screwdriver cross-recess PH0
5-049-13	ESD SMD tweezers 110 mm form 4 stainless steel dissipative
5-055-13	ESD SMD tweezers 120 mm form 7a stainless steel angle 40° dissipative
5-059-13	ESD SMD tweezers 120 mm form 2a stainless steel dissipative
6-661	ESD torx screwdriver T5
6-662	ESD torx screwdriver T6
6-663 L	ESD torx screwdriver T7
7-422	ESD brush bristles width 20 mm



2286

► 9-354 ESD Handling Set pcs

Art.-No.	Content
9-354-100	ESD table mat 500 x 400 x 0.5 mm
9-342-1	ESD contact bracelet blue
9-342-2	ESD spiral cord for bracelet 2.5 m black
9-343-1	ESD grounding cable 1 MOhms, 1500mm 2 press-studs 10/10 mm
9-353	ESD crocodile clip

Outer dimensions (closed):
350 x 310 x 65 mm

2282: 1500 g
2286: 1250 g

2282: 23 tools
2286: 18 tools

ESD tool set TRENDY C **2282**
ESD tool set TRENDY C **2286**



ESD REPAIR SET

► 2290 ESD tool set PROFI repair set 28 pcs

Handy tool flap bag made from dissipative synthetic leather. The bag has a total of 24 rubber loops for holding tools and other parts. Thanks to its design, the tool area can be set up with a Velcro loop, which significantly improves access to the tools. The bag has two press studs that can be connected to a wrist strap and a earthing cable (included), which allows each workstation to be converted to an ESD workstation.

The large support surface (480 x 340 mm) offers enough space to safely handle sensitive electronic components. For transport, the bag can be quickly folded to a handy size and closed with a rubber band.

EPA suitable for electrostatically protected areas (ESD workplaces/ESD protected zones).

Art.-No.	Content
2291	ESD dissipative folding bag 22 empty pockets
4-603	ESD screwdriver slot blade 1.5 x 0.25 x 40 mm
4-605	ESD screwdriver slot blade 2.0 x 0.40 x 40 mm
4-621	ESD screwdriver cross-recess PH000
4-622	ESD screwdriver cross-recess PH00
9-342-1	ESD contact bracelet blue
9-342-2	ESD spiral cord for bracelet 2.5 m black
9-353	ESD crocodile clip
9-343-1	ESD grounding cable 1 MOhms, 1500 mm 2 press-studs 10/10 mm
2-124	opening tool BERNSTEIN metal opener flat
2-123	ESD crowbar SPUDGER metal opener flat

Art.-No.	Content
2-111	LCD suction cup with ring
5-059-13	ESD SMD tweezers 120 mm form 2a stainless steel dissipative
5-055-13	ESD SMD tweezers 120 mm stainless steel angle 40° dissipative
2-129-1	opening tool triangle orange (6 pcs)
2-129-2	opening tool darts orange (3 pcs)
2-129-3	opening tool pen pointed orange
6-611	ESD socket wrench 1.5 mm
6-661	ESD torx screwdriver T5
6-662	ESD torx screwdriver T6
6-721	ESD screwdriver pentalobe TS1
6-724	ESD screwdriver pentalobe TS4

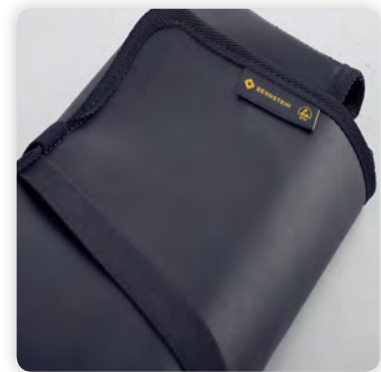



tool folder (closed)
270 x 160 x 60 mm



without tools: 480 g
with tools: 740 g



28 tools



ESD tool set PROFI Repair with tools **2290**
ESD tool set PROFI Repair without tools **2291**



ELECTRONIC TOOL SET

► 2300 ESD tool set PROFI repair set 21 pcs

The foldable tool folder made from ESD material also serves as an electrically dissipative workplace pad and, when unfolded, is 680 x 660 x 35 mm. The bleeder resistance is approx. 108 ohms in accordance with DIN 53482. The workplace pad is equipped with three press studs for connecting a contact wrist band and an earthing cable. The tool folder can be closed with two additional press studs and used as a tool wallet. The contact wristband and the earthing cable are located in the two attached pockets.

In addition, 16 dissipative tools are stored close at hand in plug-in compartments.

The large support surface (660 x 435 mm) offers enough space to handle sensitive electronic components safely. For transport, the bag can be quickly folded to a handy size.

EPA suitable for electrostatically protected areas (ESD workplaces/ESD protected zones).

Art.-No.	Content
2301	ESD dissipative folding bag 20 empty pockets
2-166	glass fibre contact cleaner brush Ø 4 mm
2-620	PLCC-extractor
4-605	ESD screwdriver slot blade 2.0 x 0.40 x 40 mm
4-606	ESD screwdriver slot blade 2.5 x 0.4 x 50 mm
4-621	ESD screwdriver cross-recess PH000
4-622	ESD screwdriver cross-recess PH00
4-623	ESD screwdriver cross-recess PH0
5-191	ESD plastic tweezers 120 mm form 2a tips 2mm wide
5-194	ESD plastic tweezers 120 mm form 6
6-611	ESD socket wrench 1.5 mm
6-616	ESD socket wrench 3.5 mm

Art.-No.	Content
6-661	ESD torx screwdriver T5
6-664 L	ESD torx screwdriver T8
6-666 L	ESD torx screwdriver T10 with hole
3-601-15	ESD side cutters CLASSICline semi flush 115 mm
3-633-15	ESD snipe nose pliers CLASSICline not serrated jaws 120 mm
4-603	ESD screwdriver slot blade 1.5 x 0.25 x 40 mm
9-342-1	ESD contact bracelet blue
9-342-2	ESD spiral cord for bracelet 2.5 m black
9-343-1	ESD grounding cable 1 MOhms, 1500 mm 2 press-studs 10/10mm
9-353	ESD crocodile clip

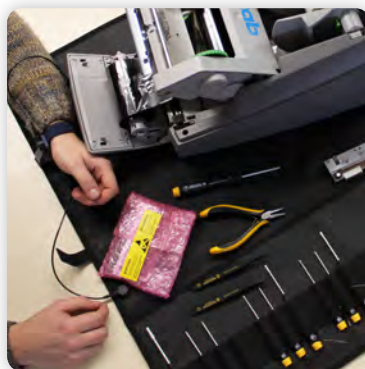



Outer dimensions (closed):
345 x 230 x 30 mm



without tools: 525 g
with tools: 870 g



21 tools



ESD tool set PROFI Repair with tools **2300**
ESD tool set PROFI Repair without tools **2301**



► 2302

NEU

ESD tool set OPERATOR KIT 5 pcs

The compact and robust bag made of dissipative imitation leather fits well into any work coat bag. Injuries caused by pointed and loosely inserted tools can thus be prevented. All tools are conductive. With their particularly slim design, the screwdrivers are ideal for narrow spaces and very practical thanks to the swivel cap. Scissors and tweezers are coated with a dissipative powder coating and can therefore also be used on sensitive components without any problems. The brush consists of dissipative plastic up to the bristles and is also particularly slim and handy.



Dimension: 65 x 340 x 270 mm



190 g



5 tools



ESD tool set OPERATOR KIT **2302**



Art.-No.	Content
5-060-0-ESD	ESD dissipative bag 6 empty pockets
4-607	ESD screwdriver slot blade 3.0 x 0.5 x 50 mm
4-623	ESD screwdriver cross-recess PH0
5-078-13	ESD SMD universal tweezers 130 mm form PSF stainless steel dissipative
7-421-1	ESD/EGB brush
5-310-13	ESD scissors rounded dissipative

ELECTRONIC TOOL CASE

► 6900 ESD tool case EPA 33 pcs

A dissipative ESD tool case with an extensive array of ESD special tools. Ideal for electrostatically sensitive components and systems. This is the only dissipative tool case in a large size that is made completely of dissipative materials! This high-quality ESD case also offers all the advantages of a standard tool case

The case shells, tool boards and the dividable bottom shell are made of dissipative material and comply with DIN EN IEC Standard 10 00 15 Part 5. The tools have been successfully tested by several test laboratories in accordance with DIN EN 61340-5-1,

61340-2-1 and 61340-2-3 for work in ESD protected areas. The sturdy case shells are pressed with a sturdy double aluminium frame. 32 tools are stored close to hand in insertable compartments on two panels, one of which can be fitted on both sides. The lid of the case contains a document compartment for storing written documents. The dividable tray in the bottom of the case allows additional tools and instruments to be stored. The case has two locks and a combination lock.

Art.-No.	Content
6915	ESD dissipative tool case EPA 42 empty pockets
2-101	tin knife with ceramic blade
2-265-1	test prod red blade 1 mm
2-265-2	test prod black blade 1 mm
2-620	PLCC-extractor
3-654-15	ESD side cutters EUROline semi flush 125 mm
3-672-15	ESD end cutters EUROline flush 130 mm
3-682-15	ESD flat nose pliers EUROline not serrated jaws 130 mm
3-133-13	ESD side cutters 14 5mm dissipative
3-245-13	ESD telephone pliers serrated jaws 200 mm dissipative
3-732-13	ESD combination pliers with serration dissipative
4-603	ESD screwdriver slot blade 1.5 x 0.25 x 40 mm
4-605	ESD screwdriver slot blade 2.0 x 0.40 x 40 mm
4-606	ESD screwdriver slot blade 2.5 x 0.4 x 50 mm
4-621	ESD screwdriver cross-recess PH000
4-622	ESD screwdriver cross-recess PH00
4-623	ESD screwdriver cross-recess PH0

Art.-No.	Content
4-632	ESD screwdriver slot blade 4.0 x 0.8 x 100 mm
4-633	ESD screwdriver slot blade 5.5 x 1.0 x 125 mm
4-652	ESD screwdriver cross-recess PH1
4-653	ESD screwdriver cross-recess PH2
5-191	ESD plastic tweezers 120 mm form 2a tips 2 mm wide
5-192	ESD plastic tweezers 120 mm form F tips 3 mm wide
5-194	ESD plastic tweezers 120 mm form 6
6-611	ESD socket wrench 1.5 mm
6-612	ESD socket wrench 2.0 mm
6-617	ESD socket wrench 4.0 mm
6-621	ESD socket wrench 5.5 mm
6-659	ESD torx screwdriver T4
6-661	ESD torx screwdriver T5
6-662	ESD torx screwdriver T6
6-663 L	ESD torx screwdriver T7
6-665 L	ESD torx screwdriver T9 with hole
7-422	ESD brush bristles width 20 mm

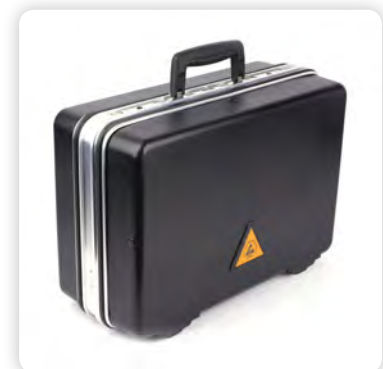



6915

7-9

1-2

3

4

5

6



Outer dimension : 500 x 370 x 210 mm
Inner dimension: 480 x 320 x 190 mm



without tools: 5800 g
with tools: 6900 g



33 tools



6900 ESD tool case EPA with tools
6915 ESD tool case EPA without tools

SERVICE SET NETWORK

► 2700 tool zipper case NETWORK 23 pcs

Special tools set for building and servicing networks. 23 special tools are clearly stored and close at hand in the rugged, black nylon zip case. On the back of the middle flap is a clamp compartment for documents.

Art.-No.	Content
2701	zipper bag 28 empty pockets
2-601	IC-tweezers 125 mm
3-603-15	ESD side cutters CLASSICline semi flush 115 mm
3-235-16	telephone pliers 160 mm with serration jaws length 55 mm
3-815-16	wire stripper with adjusting screw and opening spring
3-0605	combination crimping pliers
3-0611	crimping pliers for BNC and TNC coaxial connectors
4-522	screwdriver EUROline-Power slot blade 3.0 x 0.5 x 75 mm
4-504	screwdriver EUROline-Power slot blade 5.5 x 1.0 x 100 mm
4-532	screwdriver EUROline Power cross-recess PH0
4-533	screwdriver EUROline Power cross-recess PH1
4-534	screwdriver EUROline Power cross-recess PH2

Art.-No.	Content
5-161	clamping scissors with teething jaws
5-535	coax cable stripper Ø 4.8 - 7.5 mm
4-775	socket wrenches handle plastic spring-haft
6-203	socket wrench 6.0 mm without handle
6-205	socket wrench 8.0 mm without handle
6-207	socket wrench 10.0 mm without handle
6-772	adjustable wrench 0 - 19m m
6-985 L	screwdriver EUROline-Power TORX T10 with hole
6-986 L	screwdriver EUROline-Power TORX T15 with hole
6-987 L	screwdriver EUROline-Power TORX T20 with hole
8-390	desoldering suction pump PRAKTIK 20 mm diameter RD-7376
8-376	gas soldering iron Independent 75

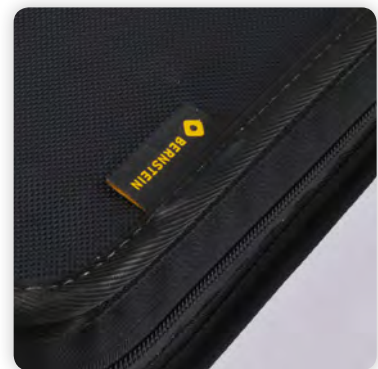

ELECTRONIC SERVICE CASE

► 1500 tool case HANDY 45 pcs

The housing made from a black-grained X-ABS plastic shell is rainproof, non-slip and shock-resistant. A sturdy aluminium profile frame provides extra stability. 45 special tools held in rubber loops are close at hand on two swivelling, perforated flaps. Regular perforation of the tool panels allows you to choose how to arrange the tools.

There is a sturdy plastic insert in the bottom of the case for spare parts, measuring or soldering devices, which can be subdivided with bars. The case has two locks and an ergonomically shaped handle as well as a padded shoulder strap.

Art.-No.	Content
1515	tool case HANDY flexible organization
1500-09	shoulder strap with protection leather black
1-152	plastic adjusting screwdriver slot blade 4x0.5x40mm
2-126	ESD desoldering lever slotted at one ends
2-127	ESD tin knife pointed sharp blade
2-132	spring puller 175 mm
2-166	glass fibre contact cleaner brush Ø 4 mm
2-265-1	test prod red blade 1 mm
2-265-2	test prod black blade 1 mm
2-275	magnifying mirror Ø 21 mm 180 mm long
2-601	IC-tweezers 125 mm
2-620	PLCC-extractor
3-603-15	ESD side cutters CLASSICline semi flush 115 mm
3-132-16	side cutters 130 mm
3-632-15	ESD flat nose pliers CLASSICline not serrated jaws 120 mm
3-634-15	ESD snipe nose pliers CLASSICline not serrated jaws 120 mm
4-523	screwdriver EUROline-Power slot blade 4.0 x 0.8 x 100 mm
4-542	screwdriver EUROline Power cross-recess PZ0

Art.-No.	Content
4-543	screwdriver EUROline Power cross-recess PZ1
4-301	Liliput screwdriver slot blade 2.0 x 0.65 x 40 mm
4-311	screwdriver slot blade 2.8 x 0.6 x 80 mm
4-343 VDE	VDE voltage tester slot blade 3.0 x 0.7 x 60 mm
4-366-AL	watchmaker screwdriver cross-recess PH00
4-392	watchmaker screwdriver magazin 6 pcs (1.5 - 2.0 - 2.5 - 3.0 - PH0 + handle)
5-006	component tweezers 145 mm jaws insulated
5-107	anatomical tweezers 150 mm form 22b
5-181	wire scraper tweezers 125 mm
5-301	scissors with teething
5-515	cutter knife 140 mm
4-775	socket wrenches handle plastic spring-haft
6-202	socket wrench 5.5 mm without handle
6-204	socket wrench 7.0 mm without handle
6-771	adjustable wrench 0 - 13 mm
6-820	wrench key set 8 pcs (1.5 - 2.0 - 2.5 - 3.0 - 4.0 - 5.0 - 5.5 - 6.0)
7-425	dust brush bristles width 25 mm

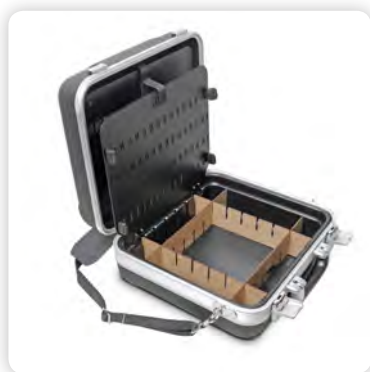



1515



Inner dimension:
320 x 295 x 160 mm



without tools: 2700 g
with tools: 3900 g



45 tools



1500 tool case HANDY with tools
1515 tool case HANDY without tools

TOOL BAG

► 5750 tool shoulder bag FACILITY 41 pcs

The ideal companion for the mobile use of tools. It can be carried in a practical way, leaving the hands free for other tasks. Thanks to its compact design, the bag can also be used on ladders, for example. The tool set contains the most important tools, making it suitable for many service cases.

The compact shoulder bag made of genuine cowhide is equipped with an adjustable shoulder strap and shoulder pad.

The bag body is reinforced with aluminium corners and is closed with the patented magnetic twist lock (one-handed operation). The front, rear and centre walls have a total of 20 pockets for tools of all kinds. The transparent clamping compartment offers space for documents.

Art.-No.	Content
5755	tool case shoulder bag 20 empty pockets
13-906 VDE	VDE side cutters 160 mm
13-915 VDE	VDE telephone pliers 160 mm serrated jaws straight with wire cutter
13-936 VDE	VDE combination pliers 160 mm with serration
14-651 VDE	VDE screwdriver slot blade 2.5 x 75 mm
14-652 VDE	VDE screwdriver slot blade 3.5 x 100 mm
14-654 VDE	VDE screwdriver slot blade 5.5 x 125 mm
14-682 VDE	VDE screwdriver cross-recess PH1 Ø 4.5 mm
14-683 VDE	VDE screwdriver cross-recess PH2 Ø 6.0 mm
3-575-6	water pump pliers 240 mm
3-601-15	ESD side cutters CLASSICline semi flush 115 mm
4-343 VDE	VDE voltage tester slot blade 3.0 x 0.7 x 60 mm

Art.-No.	Content
4-393	watchmaker screwdriver magazin 6 pcs (1.5 - 2.0 - 2.5 - PH00 - PH000 + handle)
5-121	anatomical tweezers 120 mm form 16 serrated
5-274	engineer file 200 mm half round wooden handle
5-517	cutter knife 160 mm
6-500	double open-ended wrench set 8 pcs (6 x 7 - 8 x 9 - 10 x 11 - 12 x 13 - 14 x 15 - 16 x 17 - 18 x 19 - 20 - 22)
6-820	wrench key set 8 pcs (1.5 - 2.0 - 2.5 - 3.0 - 4.0 - 5.0 - 5.5 - 6.0)
7-114	engineer hammer to DIN 1041, 200 g
7-316	punch blade Ø 6 mm blade length 100 mm
7-502	folding rule 2 meter wood
7-535	spirit level 225 mm
7-616	PUK saw in case





5755



Outer dimension: 325 x 250 x 160 mm
Inner dimension: 300 x 230 x 140 mm



without tools: 1500 g
with tools: 4200 g



41 tools



5750 tool shoulder bag FACILITY with tools
5755 tool shoulder bag FACILITY without tools

TOOL CASE

PERFORMANCE

JUST DIFFERENT



OUTSIDE

The PERFORMANCE case strikes a good balance between price and performance. Reduced to the most important functions, it represents an inexpensive alternative to the PROTECTION.

The use of X-ABS plastic with an extremely non-slip surface makes the case more resistant to external influences. The impact resistant and break-proof material also makes the suitcase „airworthy“ as it withstands the harsh handling checked luggage is subjected to.

The sturdy aluminium frame and ratchet hinges with a case lid locking add the finishing touches to the look of this high-quality and functional tool case.

Case shell made of robust X-ABS plastic and stable aluminum profile frame

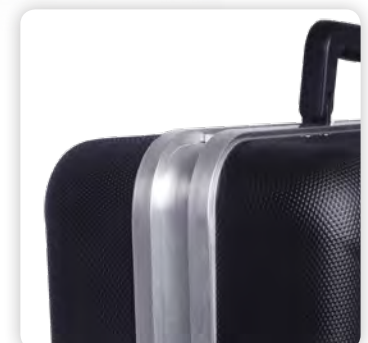

The PERFORMANCE case includes the following:

The lid has a built-in tool panel with 22 compartments on the front and back. The bottom shell is available in two designs:



4415
Floor panel with 32 compartments, optimal for many small tools
54 insertion options



5015
Floor panel with 6 compartments, 28 insertion options

INSIDE

The tool panels made from CONPEARL® with stitched fabric pockets are sturdy and washable. The base tray is divided with removable partitions.

stable handle



divisible bottom shell



tilt locks



Outer dimension: 480 x 350 x 190 mm
Inner dimension: 460 x 320 x 180 mm



4415: 3900 g
5015: 3900 g

TOOL SET PC-CONTACT

► 4100 tool case PC-CONTACT 61 pcs

A service case with tools for installing and servicing computers and peripheral equipment.

The PERFORMANCE case strikes a good balance between price and performance. Reduced to the most important functions, it represents an inexpensive alternative to PROTECTION. The use of X-ABS plastic with an extremely non-slip surface makes the case resistant to external influences.

The impact resistant and break-proof material also makes the suitcase „airworthy“ as it withstands the harsh handling checked luggage is subjected to. The sturdy aluminium frame and ratchet hinges with case lid locking add the finishing touches to the look of this high-quality and functional tool case.

Art.-No.	Content
4415	tool case PERFORMANCE 54 empty pockets
2-127	ESD tin knife pointed sharp blade
2-132	spring puller 175mm
2-161	scriber, magnetic lifter with telescopic slide-out
2-166	glass fibre contact cleaner brush Ø 4 mm
2-265-1	test prod red blade 1 mm
2-265-2	test prod black blade 1 mm
2-275	magnifying mirror Ø 21 mm 180 mm
2-601	IC-tweezers 125 mm
2-620	PLCC-extractor
3-601-15	ESD side cutters CLASSICline semi flush 115 mm
3-606-15	ESD side cutters CLASSICline flush 120 mm
3-632-15	ESD flat nose pliers CLASSICline not serrated jaws 120 mm
3-633-15	ESD snipe nose pliers CLASSICline not serrated jaws 120 mm
4-331	screwdriver slot blade 6.0 x 1.0 x 65 mm
4-343 VDE	VDE voltage tester slot blade 3.0 x 0.7 x 60 mm
4-522	screwdriver EUROline-Power slot blade 3.0 x 0.5 x 75 mm
4-523	screwdriver EUROline-Power slot blade 4.0 x 0.8 x 100 mm
4-533	screwdriver EUROline Power cross-recess PH1
4-542	screwdriver EUROline Power cross-recess PZO
4-543	screwdriver EUROline Power cross-recess PZ1
4-603	ESD screwdriver slot blade 1.5 x 0.25 x 40 mm
4-607	ESD screwdriver slot blade 3.0 x 0.5 x 50 mm
4-621	ESD screwdriver cross-recess PH000
4-622	ESD screwdriver cross-recess PH00

Art.-No.	Content
4-623	ESD screwdriver cross-recess PH0
5-107	anatomical tweezers 150 mm form 22b
5-117	anatomical tweezers 145 mm form 40 serrated
5-210	needle files set 6 pcs (flat, round, blunt, pointed, 3-edge, 4-edge)
5-305	scissors 140 mm
4-775	socket wrenches handle plastic spring-haft
6-201	socket wrench 4.0 mm without handle
6-202	socket wrench 5.5 mm without handle
6-203	socket wrench 6.0 mm without handle
6-204	socket wrench 7.0 mm without handle
6-205	socket wrench 8.0 mm without handle
6-206	socket wrench 9.0 mm without handle
6-207	socket wrench 10.0 mm without handle
6-661	ESD torx screwdriver T5
6-663 L	ESD torx screwdriver T7
6-750-3	double open-ended wrench 3 x 3.5 mm
6-750-4	double open-ended wrench 4 x 4.5 mm
6-750-5	double open-ended wrench 5 x 5.5 mm
6-750-6	double open-ended wrench 6 x 6.5 mm
6-771	adjustable wrench 0 - 13 mm
6-820	wrench key set 8 pcs (1.5 - 2.0 - 2.5 - 3.0 - 4.0 - 5.0 - 5.5 - 6.0)
6-984 L	screwdriver EUROline-Power TORX T9 with hole
6-985 L	screwdriver EUROline-Power TORX T10 with hole
6-986 L	screwdriver EUROline-Power TORX T15 with hole
7-425	dust brush bristles width 25mm



4415



Outer dimension: 480 x 350 x 190 mm
Inner dimension: 460 x 320 x 180 mm



without tools: 3900 g
with tools: 5400 g



62 tools



4100 tool case PC-CONTACT with tools
4415 tool case PC-CONTACT without tools



TOOL SET TECHNIC

► 4400 tool case TECHNIC 69 pcs

A toolbox for technicians. All the tools are clearly arranged on two tool panels.

The PERFORMANCE case strikes a good balance between price and performance. Reduced to the most important functions, it represents an inexpensive alternative to PROTECTION. The use of X-ABS plastic with an extremely non-slip surface makes

the case resistant to external influences. The impact resistant and break-proof material also makes the suitcase „airworthy“ as it withstands the harsh handling checked luggage is subjected to. The sturdy aluminium frame and ratchet hinges with case lid locking add the finishing touches to the look of this high-quality and functional tool case.

Art.-No.	Content
4415	tool case PERFORMANCE 54 empty pockets
1-909	engineer mirror with extension Ø 23 mm
2-126	ESD desoldering lever slotted at one ends
2-127	ESD tin knife pointed sharp blade
2-128	ESD tin scraper sharp chisel form
2-132	spring puller 175 mm
2-161	scriber, magnetic lifter with telescopic slide-out
2-265-1	test prod red blade 1 mm
2-265-2	test prod black blade 1 mm
2-601	IC-tweezers 125 mm
3-132-16	side cutters 130 mm
3-601-15	ESD side cutters CLASSICline semi flush 115 mm
3-632-15	ESD flat nose pliers CLASSICline not serrated jaws 120 mm
3-634-15	ESD snipe nose pliers CLASSICline not serrated jaws 120 mm
3-732-16	combinations pliers 165 mm with serration
4-301	Liliput screwdriver slot blade 2.0 x 0.65 x 40 mm
4-311	screwdriver slot blade 2.8 x 0.6 x 80 mm
4-343 VDE	VDE voltage tester slot blade 3.0 x 0.7 x 60 mm
4-351	offset screwdriver slot blade 4.5 x 0.65 x 100 mm
4-393	watchmaker screwdriver magazin 6 pcs (1.5 - 2.0 - 2.5 - PH00 - PH000 + handle)
5-006	component tweezers 145 mm jaws insulated
5-049	SMD tweezers 110 mm form 4 stainless steel
5-107	anatomical tweezers 150 mm form 22b
5-115	thermal tweezers 165 mm form R30 cross tweezers
5-117	anatomical tweezers 145 mm form 40 serrated
5-161	clamping scissors with teething jaws
5-181	wire scraper tweezers 125 mm

Art.-No.	Content
5-210	needle files set 6 pcs (flat, round, blunt, pointed, 3-edge, 4-edge)
5-301	scissors with teething
5-501	cable knife (open 200 mm)
5-531	automatic wire stripper 0.2 - 6 mm ² with stop
4-775	socket wrenches handle plastic spring-haft
6-201	socket wrench 4.0 mm without handle
6-202	socket wrench 5.5 mm without handle
6-203	socket wrench 6.0 mm without handle
6-204	socket wrench 7.0 mm without handle
6-205	socket wrench 8.0 mm without handle
6-206	socket wrench 9.0 mm without handle
6-207	socket wrench 10.0 mm without handle
6-750-3	double open-ended wrench 3 x 3.5 mm
6-750-4	double open-ended wrench 4 x 4.5 mm
6-750-5	double open-ended wrench 5 x 5.5 mm
6-750-6	double open-ended wrench 6 x 6.5 mm
6-820	wrench key set 8 pcs (1.5 - 2.0 - 2.5 - 3.0 - 4.0 - 5.0 - 5.5 - 6.0)
7-425	dust brush bristles width 25 mm
7-508	steel tape measure 30 cm
7-511	digital caliper DIN862 precision 150 mm
7-616	PUK saw in case
14-651 VDE	VDE screwdriver slot blade 2.5 x 75 mm
14-653 VDE	VDE screwdriver slot blade 4.0 x 100 mm
14-654 VDE	VDE screwdriver slot blade 5.5 x 125 mm
14-681 VDE	VDE screwdriver cross-recess PH0 Ø 3.0 mm
14-692 VDE	VDE screwdriver cross-recess PZ1 Ø 4.5 mm



4415



Outer dimension: 480 x 350 x 190 mm
Inner dimension: 460 x 320 x 180 mm



without tools: 3900 g
with tools: 6300 g



69 tools



4400 tool case TECHNIC with tools
4415 tool case TECHNIC without tools

TOOL SET TELEDATA

► 4700 tool case TELEDATA 56 pcs

The case with special tools for installing and servicing telecommunication systems, data networks and for working with VDE-insulated tools.

The PERFORMANCE case strikes a good balance between price and performance. Reduced to the most important functions, it represents an inexpensive alternative to PROTECTION. The use of X-ABS plastic with an extremely non-slip surface makes

the case resistant to external influences. The impact resistant and break-proof material also makes the suitcase „airworthy“ as it withstands the harsh handling checked luggage is subjected to. The sturdy aluminium frame and ratchet hinges with case lid locking add the finishing touches to the look of this high-quality and functional tool case.

Art.-No.	Content
5015	tool case PERFORMANCE 28 empty pockets
2-265-1	test prod red blade 1 mm
2-265-2	test prod black blade 1 mm
2-601	IC-tweezers 125 mm
2-620	PLCC-extractor
2-701	LSA-Plus insertion tool
3-573	water pump pliers 180 mm with push-button
3-601-15	ESD side cutters CLASSICline semi flush 115 mm
3-0605	combination crimping pliers
5-107	anatomical tweezers 150 mm form 22b
5-117	anatomical tweezers 145 mm form 40 serrated
5-240	warding files set 6 pcs (flat, round, blunt, pointed, 3-edge, 4-edge)
5-505	stripping knife Ø 4 - 28 mm with hook blade
6-500	double open-ended wrench set 8 pcs (6 x 7 - 8 x 9 - 10 x 11 - 12 x 13 - 14 x 15 - 16 x 17 - 18 x 19 - 20 - 22)
6-820	wrench key set 8 pcs (1.5-2.0-2.5-3.0-4.0-5.0-5.5-6.0)
6-995	TORX wrench key set with hole 8 pcs (T9 - T10 - T15 - T20 - T25 - T27 - T30 - T40)

Art.-No.	Content
7-425	dust brush bristles width 25 mm
7-502	folding rule 2 meter wood
7-616	PUK saw in case
13-906 VDE	VDE side cutters 160 mm
13-915 VDE	VDE telephone pliers 160 mm serrated jaws straight with wire cutter
13-927 VDE	VDE flat nose pliers 160 mm with serration
14-651 VDE	VDE screwdriver slot blade 2.5 x 75 mm
14-652 VDE	VDE screwdriver slot blade 3.5 x 100 mm
14-653 VDE	VDE screwdriver slot blade 4.0 x 100 mm
14-681 VDE	VDE screwdriver cross-recess PH0 Ø 3.0 mm
14-682 VDE	VDE screwdriver cross-recess PH1 Ø 4.5 mm
14-683 VDE	VDE screwdriver cross-recess PH2 Ø 6.0 mm
16-299 VDE	VDE socket wrench 4.0 mm
16-301 VDE	VDE socket wrench 5.0 mm
16-302 VDE	VDE socket wrench 5.5 mm



5015



Outer dimension: 480 x 350 x 190 mm
Inner dimension: 460 x 320 x 180 mm



without tools: 3900 g
with tools: 6800 g



56 tools



4700 tool case TELEDATA with tools
5015 tool case TELEDATA without tools

TOOL SET SECURITY

► 4750 tool case SECURITY 54 pcs

A tool box with the basic array of special tools for installing and servicing complex security and alarm systems, as well as for working with VDE-insulated tools and soldering with mains-independent gas soldering irons.

The PERFORMANCE case strikes a good balance between price and performance. Reduced to the most important functions, it represents an inexpensive alternative to PROTECTION.

The use of X-ABS plastic with an extremely non-slip surface makes the case resistant to external influences. The impact resistant and break-proof material also makes the suitcase „airworthy“ as it withstands the harsh handling checked luggage is subjected to. The sturdy aluminium frame and ratchet hinges with case lid locking add the finishing touches to the look of this high-quality and functional tool case.

Art.-No.	Content
5015	tool case PERFORMANCE 28 empty pockets
2-265-1	test prod red blade 1 mm
2-265-2	test prod black blade 1 mm
2-701	LSA-Plus insertion tool
3-601-15	ESD side cutters CLASSICline semi flush 115 mm
3-0611	crimping pliers for BNC and TNC coaxial connectors
4-343 VDE	VDE voltage tester slot blade 3.0 x 0.7 x 60 mm
5-505	stripping knife Ø 4 - 28 mm with hook blade
5-515	cutter knife 140 mm
5-531	automatic wire stripper 0.2 - 6 mm ² with stop
5-535	coax cable stripper Ø 4.8 - 7.5 mm
6-500	double open-ended wrench set 8 pcs (6 x 7 - 8 x 9 - 10 x 11 - 12 x 13 - 14 x 15 - 16 x 17 - 18 x 19 - 20 - 22)
6-820	wrench key set 8 pcs (1.5 - 2.0 - 2.5 - 3.0 - 4.0 - 5.0 - 5.5 - 6.0)
6-995	TORX wrench key set with hole 8 pcs (T9 - T10 - T15 - T20 - T25 - T27 - T30 - T40)
7-114	engineer hammer to DIN 1041, 200 g
7-425	dust brush bristles width 25 mm
7-502	folding rule 2 meter wood

Art.-No.	Content
7-535	spirit level 225 mm
7-616	PUK saw in case
8-376	gas soldering iron Independent 75
8-390	desoldering suction pump PRAKTIK 20 mm diameter RD-7376
13-906 VDE	VDE side cutters 160 mm
13-915 VDE	VDE telephone pliers 160 mm serrated jaws straight with wire cutter
13-927 VDE	VDE flat nose pliers 160 mm with serration
13-936 VDE	VDE combination pliers 160 mm with serration
14-651 VDE	VDE screwdriver slot blade 2.5 x 75 mm
14-652 VDE	VDE screwdriver slot blade 3.5 x 100 mm
14-653 VDE	VDE screwdriver slot blade 4.0 x 100 mm
14-681 VDE	VDE screwdriver cross-recess PH0 Ø 3.0 mm
14-682 VDE	VDE screwdriver cross-recess PH1 Ø 4.5 mm
14-683 VDE	VDE screwdriver cross-recess PH2 Ø 6.0 mm
16-299 VDE	VDE socket wrench 4.0 mm
16-301 VDE	VDE socket wrench 5.0 mm
16-302 VDE	VDE socket wrench 5.5 mm



5015



Outer dimension: 480 x 350 x 190 mm
Inner dimension: 460 x 320 x 180 mm



without tools: 3900 g
with tools: 7500 g



54 tools



4700 tool case SECURITY with tools
5015 tool case SECURITY without tools



TOOL SET BASIC, ADVANCED AND COMPLETE

► 5000 BAS tool case BASIC 51 pcs

Basic equipment with the most important tools (BASIC), expanded basic equipment with additional crimping/pressing pliers and other important screwdrivers (ADVANCED), expanded basic equipment with supplementary equipment for mobile soldering (COMPLETE).

The PERFORMANCE case strikes a good balance between price and performance. Reduced to the most important functions, it represents an inexpensive alternative to PROTECTION.

basic equipment:

Art.-No.	Content
5015	tool case PERFORMANCE 28 empty pockets
3-0856	crimping pliers/wire stripper
3-575-6	water pump pliers 240 mm
3-601-15	ESD side cutters CLASSICline semi flush 115 mm
4-343 VDE	VDE voltage tester slot blade 3.0 x 0.7 x 60 mm
4-392	watchmaker screwdriver magazin 6 pcs (1.5 - 2.0 - 2.5 - 3.0 - PH0 + handle)
4-508	screwdriver EUROline-Power slot blade 8.0 x 1.2 x 150 mm
4-524	screwdriver EUROline-Power slot blade 5.0 x 1.0 x 150 mm
5-107-6	tweezers 150 mm form 22b teething,insulated
5-240	warding files set 6 pcs (flat, round, blunt, pointed, 3-edge, 4-edge)
5-505	stripping knife Ø 4 - 28 mm with hook blade
6-500	double open-ended wrench set 8 pcs (6 x 7 - 8 x 9 - 10 x 11 - 12 x 13 - 14 x 15 - 16 x 17 - 18 x 19 - 20 - 22)
6-820	wrench key set 8 pcs (1.5 - 2.0 - 2.5 - 3.0 - 4.0 - 5.0 - 5.5 - 6.0)
7-116	engineer hammer to DIN 1041, 300 g

The use of X-ABS plastic with an extremely non-slip surface makes the case resistant to external influences. The impact resistant and break-proof material also makes the suitcase „airworthy“ as it withstands the harsh handling checked luggage is subjected to. The sturdy aluminium frame and ratchet hinges with case lid locking add the finishing touches to the look of this high-quality and functional tool case.

Art.-No.	Content
7-235	flat chisel 200 x 14 x 20 mm
7-255	electrician's chisel with safety impact head 200 x 8 x 10 mm
7-316	punch blade Ø 6mm blade length 100 mm
7-502	folding rule 2 meter wood
7-535	spirit level 225 mm
7-616	PUK saw in case
13-906 VDE	VDE side cutters 160 mm
13-915 VDE	VDE telephone pliers 160 mm serrated jaws straight with wire cutter
13-936 VDE	VDE combination pliers 160 mm with serration
14-653 VDE	VDE screwdriver slot blade 4.0 x 100 mm
14-651 VDE	VDE screwdriver slot blade 2.5 x 75 mm
14-652 VDE	VDE screwdriver slot blade 3.5 x 100 mm
14-682 VDE	VDE screwdriver cross-recess PH1 Ø 4.5 mm
14-683 VDE	VDE screwdriver cross-recess PH2 Ø 6.0 mm

► 5000 ADV tool case ADVANCED 67 pcs

Extension of tool case BASIC

Art.-No.	Content
5000 BAS	Basic equipment
3-0612	automatic crimping pliers 0,5 - 1,0 / 1,54 - 2,5 / 4 - 6 mm ²
3-871-6	pressing pliers 155 mm for wire 0.25-2.5 mm ²
6-200	socket wrench set 8 pcs (4 - 5.5 - 6 - 7 - 8 - 9 - 10 + handle)
6-995	TORX wrench key set with hole 8 pcs (T9 - T10 - T15 - T20 - T25 - T27 - T30 - T40)

► 5000 COM tool case COMPLETE 72 pcs

Extension of tool case BASIC including soldering tools

Art.-No.	Content
5000 BAS	Basic equipment
3-0612	automatic crimping pliers 0,5 - 1,0 / 1,54 - 2,5 / 4 - 6 mm ²
3-871-6	pressing pliers 155 mm for wire 0.25-2.5 mm ²
6-200	socket wrench set 8 pcs (4 - 5.5 - 6 - 7 - 8 - 9 - 10 + handle)
6-995	TORX wrench key set with hole 8 pcs (T9 - T10 - T15 - T20 - T25 - T27 - T30 - T40)
7-429	insulating tape 25mm wide, 25 m (12 mm core)
8-390	desoldering suction pump PRAKTIK 20 mm diameter RD-7376
8-376	gas soldering iron Independent 75 (replacement tips on request)



5015



Outer dimension: 480 x 350 x 190 mm
 Inner dimension: 460 x 320 x 180 mm



without tools: 3900 g
 5000 BAS: 7400 g
 5000 ADV: 8500 g
 5000 COM: 8700 g



5000 BAS tool case BASIC 51 pcs
5000 ADV tool case ADVANCED 67 pcs
5000 COM tool case COMPLETE 72 pcs
5015 tool case PERFORMANCE without tools



CASES AND SETS
 not dissipative

TOOL CASE

PROTECTION

BE WELL CARED!



ergonomic handle



OUTSIDE

The compact shape and the textured surface provide the case with a high degree of stability and give it its unmistakable BERNSTEIN design.

The use of X-ABS plastic with an extremely non-slip surface makes the case more resistant to external influences. The impact resistant and break-proof material also makes the suitcase „airworthy“ as it withstands the harsh handling checked luggage is subjected to.

The ergonomically shaped handle with a recess and ratchet hinges with case lid locking add the finishing touches to the look of this highly functional and modern tool case.

Case shell made of robust X-ABS plastic



The PROTECTION case includes the following:

A document compartment is located in the lid as well as a removable tool panel with 26 compartments on the front and back. The bottom shell is available in two designs:



6415
Floor panel with 32 compartments, optimal for many small tools
58 insertion options



6755
Floor panel with 16 compartments
42 insertion options

Document compartment in case lid



OPTIONAL:
additional tool board with 10 compartments



divisible bottom tray

INSIDE

The tool panels made from CONPEARL® with stitched fabric pockets are sturdy, washable and interchangeable. The bottom tray can be divided with removable partitions.



Outer dimension: 480 x 350 x 190 mm
Inner dimension: 460 x 320 x 180 mm



6415: 4400 g
6755: 4300 g

tilt locks

on request with TSA-LOCK- (for USA travellers) or combination locks available



TOOL SET PC CONTACT

► 6100 tool case PC-CONTACT 65 pcs

A service case with tools for installing and servicing computers and peripheral equipment.

The compact shape and the textured surface provide the case with a high degree of stability and give it its unmistakable BERNSTEIN design. The use of X-ABS plastic with an extremely non-slip surface makes the case resistant to external influences. The impact resistant and break-proof material also makes the

suitcase „airworthy“ as it withstands the harsh handling checked luggage is subjected to. The ergonomically shaped handle with recessed grips and ratchet hinges with case lid locking add the finishing touches to the look of this highly functional and modern tool case.

Art.-No.	Content
6415	tool case PROTECTION 58 empty pockets
2-127	ESD tin knife pointed sharp blade
2-132	spring puller 175 mm
2-161	scriber, magnetic lifter with telescopic slide-out
2-166	glass fibre contact cleaner brush Ø 4 mm
2-265-1	test prod red blade 1 mm
2-265-2	test prod black blade 1 mm
2-275	magnifying mirror Ø 21 mm 180 mm long
2-601	IC-tweezers 125 mm
2-620	PLCC-extractor
3-601-15	ESD side cutters CLASSICline semi flush 115 mm
3-606-15	ESD side cutters CLASSICline flush 120 mm
3-632-15	ESD flat nose pliers CLASSICline not serrated jaws 120 mm
3-633-15	ESD snipe nose pliers CLASSICline not serrated jaws 120 mm
3-634-15	ESD snipe nose pliers CLASSICline not serrated jaws 120 mm
4-331	screwdriver slot blade 6.0 x 1.0 x 65 mm
4-343 VDE	VDE voltage tester slot blade 3.0 x 0.7 x 60 mm
4-522	screwdriver EUROline-Power slot blade 3.0 x 0.5 x 75 mm
4-523	screwdriver EUROline-Power slot blade 4.0 x 0.8 x 100 mm
4-533	screwdriver EUROline Power cross-recess PH1
4-542	screwdriver EUROline Power cross-recess PZ0
4-543	screwdriver EUROline Power cross-recess PZ1
4-603	ESD screwdriver slot blade 1.5 x 0.25 x 40 mm
4-607	ESD screwdriver slot blade 3.0 x 0.5 x 50 mm

Art.-No.	Content
4-621	ESD screwdriver cross-recess PH000
4-622	ESD screwdriver cross-recess PH00
4-623	ESD screwdriver cross-recess PH0
4-624	ESD screwdriver cross-recess PH1
5-107	anatomical tweezers 150 mm form 22b
5-117	anatomical tweezers 145 mm form 40 serrated
5-210	needle files set 6 pcs (flat, round, blunt, pointed, 3-edge, 4-edge)
5-305	scissors 140 mm
6-200	socket wrench set 8 pcs (4 - 5.5 - 6 - 7 - 8 - 9 - 10 + handle)
6-661	ESD torx screwdriver T5
6-663 L	ESD torx screwdriver T7
6-750-3	double open-ended wrench 3 x 3.5 mm
6-750-4	double open-ended wrench 4 x 4.5 mm
6-750-5	double open-ended wrench 5 x 5.5 mm
6-750-6	double open-ended wrench 6 x 6.5 mm
6-750-7	double open-ended wrench 7 x 8 mm
6-750-9	double open-ended wrench 9 x 10 mm
6-771	adjustable wrench 0 - 13 mm
6-820	wrench key set 8 pcs (1.5 - 2.0 - 2.5 - 3.0 - 4.0 - 5.0 - 5.5 - 6.0)
6-984 L	screwdriver EUROline-Power TORX T9 with hole
6-985 L	screwdriver EUROline-Power TORX T10 with hole
6-986 L	screwdriver EUROline-Power TORX T15 with hole
7-425	dust brush bristles width 25 mm



6415



Outer dimension: 480 x 350 x 190 mm
 Inner dimension: 460 x 320 x 180 mm



without tools: 4400 g
 with tools: 6100 g



65 tools



6100 tool case PC-CONTACT with tools
6415 tool case PC-CONTACT without tools

CASES AND SETS
 not dissipative

TOOL SET TECHNIC

► 6400 tool case TECHNIK 78 pcs

A toolbox for technicians. All the tools are clearly arranged on two tool panels.

The compact shape and the textured surface provide the case with a high degree of stability and give it its unmistakable BERNSTEIN design. The use of X-ABS plastic with an extremely non-slip surface makes the case resistant to external influences. The impact resistant and break-proof material also makes the

suitcase „airworthy“ as it withstands the harsh handling checked luggage is subjected to. The ergonomically shaped handle with recessed grips and ratchet hinges with case lid locking add the finishing touches to the look of this highly functional and modern tool case.

Art.-No.	Content
6415	tool case PROTECTION 58 empty pockets
1-909	engineer mirror with extension Ø 23 mm
2-126	ESD desoldering lever slotted at one ends
2-127	ESD tin knife pointed sharp blade
2-128	ESD tin scraper sharp chisel form
2-132	spring puller 175 mm
2-145	screwdriver with guide sleeve
2-161	scriber, magnetic lifter with telescopic slide-out
2-265-1	test prod red blade 1 mm
2-265-2	test prod black blade 1 mm
2-601	IC-tweezers 125 mm
3-132-16	side cutters 130 mm
3-601-15	ESD side cutters CLASSICline semi flush 115 mm
3-606-15	ESD side cutters CLASSICline flush 120 mm
3-631-15	ESD round nose pliers CLASSICline not serrated jaws 120 mm
3-632-15	ESD flat nose pliers CLASSICline not serrated jaws 120 mm
3-634-15	ESD snipe nose pliers CLASSICline not serrated jaws 120 mm
3-732-16	combinations pliers 165 mm with serration
4-261	screwdriver short cross-recess PH1
4-301	Liliput screwdriver slot blade 2.0 x 0.65 x 40 mm
4-311	screwdriver slot blade 2.8 x 0.6 x 80 mm
4-321	screwdriver short slot blade 4.0 x 0.8 x 25 mm
4-343 VDE	VDE voltage tester slot blade 3.0 x 0.7 x 60 mm
4-351	offset screwdriver slot blade 4.5 x 0.65 x 100 mm
4-366-AL	watchmaker screwdriver cross-recess PH00
4-392	watchmaker screwdriver magazin 6 pcs (1.5 - 2.0 - 2.5 - 3.0 - PH0 + handle)
5-006	component tweezers 145 mm jaws insulated
5-049	SMD tweezers 110 mm form 4 stainless steel

Art.-No.	Content
5-107	anatomical tweezers 150 mm form 22b
5-115	thermal tweezers 165 mm form R30 cross tweezers
5-117	anatomical tweezers 145 mm form 40 serrated
5-161	clamping scissors with teething jaws
5-181	wire scraper tweezers 125 mm
5-210	needle files set 6 pcs (flat, round, blunt, pointed, 3-edge, 4-edge)
5-301	scissors with teething
5-501	cable knife (open 200 mm)
6-200	socket wrench set 8 pcs (4 - 5.5 - 6 - 7 - 8 - 9 - 10 + handle)
6-750-3	double open-ended wrench 3 x 3.5 mm
6-750-4	double open-ended wrench 4 x 4.5 mm
6-750-5	double open-ended wrench 5 x 5.5 mm
6-750-6	double open-ended wrench 6 x 6.5 mm
6-750-7	double open-ended wrench 7 x 8 mm
6-750-9	double open-ended wrench 9 x 10 mm
6-820	wrench key set 8 pcs (1.5 - 2.0 - 2.5 - 3.0 - 4.0 - 5.0 - 5.5 - 6.0)
7-425	dust brush bristles width 25 mm
7-435	oiler with brass rotating seal 40 ml
7-508	steel tape measure 30 cm
7-511	digital caliper DIN862 precision 150 mm
7-616	PUK saw in case
14-651 VDE	VDE screwdriver slot blade 2.5 x 75 mm
14-653 VDE	VDE screwdriver slot blade 4.0 x 100 mm
14-654 VDE	VDE screwdriver slot blade 5.5 x 125 mm
14-681 VDE	VDE screwdriver cross-recess PH0 Ø 3.0 mm
15-531 VDE	VDE automatic wire stripper (0.2 - 6.0 mm ²) with stop screw
14-692 VDE	VDE screwdriver cross-recess PZ1 Ø 4.5 mm



6415

1-2

3

4

5

7-9

13-16



Outer dimension: 480 x 350 x 190 mm
Inner dimension: 460 x 320 x 180 mm



without tools: 4400 g
with tools: 7100 g



78 tools



6400 tool case TECHNIK with tools
6415 tool case TECHNIK without tools

TOOL SET TELEDATA

► 6700 tool case TELEDATA 75 pcs

The case with special tools for installing and servicing telecommunication systems, data networks and for working with VDE-insulated tools.

The compact shape and the textured surface provide the case with a high degree of stability and give it its unmistakable BERNSTEIN design. The use of X-ABS plastic with an extremely non-slip surface makes the case resistant to external influences.

The impact resistant and break-proof material also makes the suitcase „airworthy“ as it withstands the harsh handling checked luggage is subjected to. The ergonomically shaped handle with recessed grips and ratchet hinges with case lid locking add the finishing touches to the look of this highly functional and modern tool case.

Art.-No.	Content
6755	tool case PROTECTION 52 empty pockets
2-265-1	test prod red blade 1 mm
2-265-2	test prod black blade 1 mm
2-601	IC-tweezers 125 mm
2-620	PLCC-extractor
2-701	LSA-Plus insertion tool
3-573	water pump pliers 180 mm with push-button
3-601-15	ESD side cutters CLASSICline semi flush 115 mm
3-0605	combination crimping pliers
5-107	anatomical tweezers 150 mm form 22b
5-117	anatomical tweezers 145 mm form 40 serrated
5-240	warding files set 6 pcs (flat, round, blunt, pointed, 3-edge, 4-edge)
5-505	stripping knife Ø 4 - 28 mm with hook blade
6-500	double open-ended wrench set 8 pcs (6 x 7 - 8 x 9 - 10 x 11 - 12 x 13 - 14 x 15 - 16 x 17 - 18 x 19 - 20 - 22)
6-600	combination wrench set 12 pcs (6 - 7 - 8 - 9 - 10 - 11 - 12 - 13 - 14 - 17 - 19 - 22)
6-950	ballpoint wrench key set 9 pcs (1.5 - 2.0 - 2.5 - 3.0 - 4.0 - 5.0 - 6.0 - 8.0 - 10.0)
6-995	TORX wrench key set with hole 8 pcs (T9 - T10 - T15 - T20 - T25 - T27 - T30 - T40)

Art.-No.	Content
7-425	dust brush bristles width 25 mm
7-506	tape measure 2 m
7-616	PUK saw in case
9-316	ESD chip-container 57 x 36 x 17 mm
13-906 VDE	VDE side cutters 160 mm
13-915 VDE	VDE telephone pliers 160 mm serrated jaws straight with wire cutter
13-927 VDE	VDE flat nose pliers 160 mm with serration
13-936 VDE	VDE combination pliers 160 mm with serration
14-651 VDE	VDE screwdriver slot blade 2.5 x 75 mm
14-652 VDE	VDE screwdriver slot blade 3.5 x 100 mm
14-653 VDE	VDE screwdriver slot blade 4.0 x 100 mm
14-681 VDE	VDE screwdriver cross-recess PH0 Ø 3.0 mm
14-682 VDE	VDE screwdriver cross-recess PH1 Ø 4.5 mm
14-683 VDE	VDE screwdriver cross-recess PH2 Ø 6.0 mm
14-684 VDE	VDE screwdriver cross-recess PH3 Ø 8.0 mm
16-299 VDE	VDE socket wrench 4.0 mm
16-301 VDE	VDE socket wrench 5.0 mm
16-302 VDE	VDE socket wrench 5.5 mm



Outer dimension: 480 x 350 x 190 mm
Inner dimension: 460 x 320 x 180 mm



without tools: 4300 g
with tools: 8600 g



75 tools



6700 tool case TELEDATA with tools
6755 tool case TELEDATA without tools

TOOL SET SECURITY

► 6750 tool case SECURITY 60 pcs

The case with special tools for installing and servicing telecommunication systems, data networks and for working with VDE-insulated tools.

The compact shape and the textured surface provide the case with a high degree of stability and give it its unmistakable BERNSTEIN design. The use of X-ABS plastic with an extremely non-slip surface makes the case resistant to external influences.

The impact resistant and break-proof material also makes the suitcase „airworthy“ as it withstands the harsh handling checked luggage is subjected to. The ergonomically shaped handle with recessed grips and ratchet hinges with case lid locking add the finishing touches to the look of this highly functional and modern tool case.

Art.-No.	Content
6755	tool case PROTECTION 52 empty pockets
2-265-1	test prod red blade 1 mm
2-265-2	test prod black blade 1 mm
2-701	LSA-Plus insertion tool
3-601-15	ESD side cutters CLASSICline semi flush 115 mm
3-0611	crimping pliers for BNC and TNC coaxial connectors
4-343 VDE	VDE voltage tester slot blade 3.0 x 0.7 x 60 mm
5-505	stripping knife Ø 4 - 28 mm with hook blade
5-515	cutter knife 140 mm
5-535	coax cable stripper Ø 4.8 - 7.5 mm
6-600	combination wrench set 12 pcs (6 - 7 - 8 - 9 - 10 - 11 - 12 - 13 - 14 - 17 - 19 - 22)
6-950	ballpoint wrench key set 9 pcs (1.5 - 2.0 - 2.5 - 3.0 - 4.0 - 5.0 - 6.0 - 8.0 - 10.0)
6-995	TORX wrench key set with hole 8 pcs (T9 - T10 - T15 - T20 - T25 - T27 - T30 - T40)
7-116	engineer hammer to DIN 1041, 300 g
7-425	dust brush bristles width 25 mm
7-506	tape measure 2 m
7-535	spirit level 225 mm



Art.-No.	Content
7-616	PUK saw in case
8-376	gas soldering iron Independent 75
8-390	desoldering suction pump PRAKTIK 20 mm diameter RD-7376
13-906 VDE	VDE side cutters 160 mm
13-915 VDE	VDE telephone pliers 160 mm serrated jaws straight with wire cutter
13-927 VDE	VDE flat nose pliers 160 mm with serration
13-936 VDE	VDE combination pliers 160 mm with serration
14-651 VDE	VDE screwdriver slot blade 2.5 x 75 mm
14-652 VDE	VDE screwdriver slot blade 3.5 x 100 mm
14-653 VDE	VDE screwdriver slot blade 4.0 x 100 mm
14-681 VDE	VDE screwdriver cross-recess PH0 Ø 3.0 mm
14-682 VDE	VDE screwdriver cross-recess PH1 Ø 4.5 mm
14-683 VDE	VDE screwdriver cross-recess PH2 Ø 6.0 mm
14-684 VDE	VDE screwdriver cross-recess PH3 Ø 8.0 mm
15-531 VDE	VDE automatic wire stripper (0.2 - 6.0 mm ²) with stop screw
16-299 VDE	VDE socket wrench 4.0 mm
16-301 VDE	VDE socket wrench 5.0 mm
16-302 VDE	VDE socket wrench 5.5 mm



6755

- 

 Outer dimension: 480 x 350 x 190 mm
 Inner dimension: 460 x 320 x 180 mm
- 

 without tools: 4300 g
 with tools: 8600 g
- 
60 tools
- 

6750 tool case SECURITY with tools
6755 tool case SECURITY without tools



CASES AND SETS
 not dissipative

SERVICE CASE

PROTECTION XL

**THE BIG ONE -
WITH AND
WITHOUT
WHEELS**



OUTSIDE

The rigid and robust roller case for heavy loads. With a double aluminium frame and the break-resistant X-ABS case shells, the case can carry loads of up to 40 kg and is also airworthy. The 4-fold telescopic pull-out is powder-coated and has an ergonomic handle that is form-fitting with the case handle. The wide wheelbase and the rubberised and mounted rollers allow the PROTECTION XL to also master uneven paths. The ratchet hinges with case lid lock come as standard with our tool cases.

handle and
pull-out closed
in one

The PROTECTION XL case is available with or without wheels. Both versions can be supplied with the following interior equipment:

A document compartment is located in the lid. The bottom panel is securely fixed to the dividable bottom shell.



6515 / 6515 R
the mobile workshop in a case with 90 compartments, optimal for many small tools



6615 / 6615 R
equipment with 42 compartments



7015 / 7015 OR
equipment with 58 compartments, optimal for many small tools

INSIDE

The tool panels made from CONPEARL® with stitched fabric pockets are sturdy, washable and interchangeable. The bottom tray can be divided with removable partitions.



4-fold telescopic pull-out 1020 mm pull-out height

rubberized, stored wheels



88 mm high and divisible bottom tray



OPTIONAL:
additional tool board with 10 compartments



Document compartment in case lid



Outer dimension:
480 x 350 x 190 mm
Inner dimension:
460 x 320 x 180 mm



6515:	5800 g
6515R:	8200 g
6615:	4900 g
6615R:	7350 g
7015:	7400 g
7015OR:	12500 g

tilt locks

on request with
TSA-LOCK- (for USA travellers)
or combination locks available



TOOL SET BOSS

► 6500 tool case BOSS 113 pcs

► 6500R tool case BOSS with wheels 113 pcs

The mobile workshop in a case

The rigid and robust roller case for heavy loads. With a double aluminium frame and the break-resistant X-ABS case shells, the case can carry loads of up to 40 kg and is also airworthy. The 4-fold telescopic pull-out is powder-coated and has an ergonomic handle that is form-fitting with the case handle.

Art.-No.	Content
6515	tool case PROTECTION XL BOSS 90 empty pockets
1-151	plastic adjusting screwdriver slot blade 3 x 0.5 x 40 mm
1-153	plastic adjusting screwdriver slot blade 2 x 0.7 x 130 mm
1-155	plastic adjusting screwdriver slot blade 3.5 x 0.7 x 130 mm
1-909	engineer mirror with extension Ø 23 mm
2-126	ESD desoldering lever slotted at one ends
2-127	ESD tin knife pointed sharp blade
2-128	ESD tin scraper sharp chisel form
2-132	spring puller 175 mm
2-155	claw-type gripper with 3 hardened wire claws
2-161	scriber, magnetic lifter with telescopic slide-out
2-166	glass fibre contact cleaner brush Ø 4mm
2-265-1	test prod red blade 1 mm
2-265-2	test prod black blade 1 mm
2-296	hand magnifier 3 x magnification LED light
2-601	IC-tweezers 125 mm
2-620	PLCC-extractor
2-656	LED flashlight 143 x 19 mm
3-0856	crimping pliers wire stripper
3-132-16	side cutters 130 mm
3-235-16	telephone pliers 160 mm with serration jaws length 55 mm
3-601-15	ESD side cutters CLASSICline semi flush 115 mm
3-603-15	ESD side cutters CLASSICline semi flush 115 mm
3-606-15	ESD side cutters CLASSICline flush 120 mm
3-632-15	ESD flat nose pliers CLASSICline not serrated jaws 120 mm
3-633-15	ESD snipe nose pliers CLASSICline not serrated jaws 120 mm
3-634-15	ESD snipe nose pliers CLASSICline not serrated jaws 120 mm
3-732-16	combinations pliers 165 mm with serration
3-815-16	wire stripper with adjusting screw and opening spring
3-871-6	pressing pliers 155 mm for wire 0.25-2.5 mm ²
4-301	Liliput screwdriver slot blade 2,0 x 0.65 x 40 mm
4-343 VDE	VDE voltage tester slot blade 3.0 x 0.7 x 60 mm
4-351	offset screwdriver slot blade 4.5 x 0.65 x 100 mm

The wide wheelbase and the rubberised and mounted rollers allow the PROTECTION XL to also master uneven paths. The ratchet hinges with case lid lock come as standard with our tool cases.

Art.-No.	Content
4-392	watchmaker screwdriver magazin 6 pcs (1.5 - 2.0 - 2.5 - 3.0 - PH0 + handle)
4-504	screwdriver EUROline-Power slot blade 5.5 x 1.0 x 100 mm
4-523	screwdriver EUROline-Power slot blade 4.0 x 0.8 x 100 mm
4-543	screwdriver EUROline Power cross-recess PZ1
4-603	ESD screwdriver slot blade 1.5 x 0.25 x 40 mm
4-605	ESD screwdriver slot blade 2.0 x 0.40 x 40 mm
4-606	ESD screwdriver slot blade 2.5 x 0.4 x 50 mm
4-607	ESD screwdriver slot blade 3.0 x 0.5 x 50 mm
4-608	ESD screwdriver slot blade 3.5 x 0.6 x 60 mm
4-621	ESD screwdriver cross-recess PH000
4-622	ESD screwdriver cross-recess PH00
4-623	ESD screwdriver cross-recess PH0
4-624	ESD screwdriver cross-recess PH1
5-006	socket wrenches handle plastic spring-haft
5-049	component tweezers 145 mm jaws insulated
5-107	SMD tweezers 110 mm form 4 stainless steel
5-107-6	anatomical tweezers 150 mm form 22b
5-115	tweezers 150 mm form 22b teething,insulated
5-117	thermal tweezers 165 mm form R30 cross tweezers
5-161	anatomical tweezers 145 mm form 40 serrated
5-181	clamping scissors with teething jaws
5-191	wire scraper tweezers 125 mm
5-194	ESD plastic tweezers 120 mm form 2a tips 2 mm wide
5-210	ESD plastic tweezers 120 mm form 6
5-301	needle files set 6 pcs (flat, round, blunt, pointed, 3-edge, 4-edge)
5-305	scissors with teething
5-501	scissors 140 mm
5-515	cable knife (open 200 mm)
4-775	cutter knife 140 mm
6-201	socket wrench 4.0 mm without handle
6-202	socket wrench 5.5 mm without handle
6-203	socket wrench 6.0 mm without handle

Art.-No.	Content
6-204	socket wrench 7.0 mm without handle
6-205	socket wrench 8.0 mm without handle
6-206	socket wrench 9.0 mm without handle
6-207	socket wrench 10.0 mm without handle
6-611	ESD socket wrench 1.5 mm
6-631	ESD wrench key 0.7 mm
6-632	ESD wrench key 0.9 mm
6-633	ESD wrench key 1.3 mm
6-634	ESD wrench key 1.5 mm
6-635	ESD wrench key 2.0 mm
6-658	ESD torx screwdriver T3
6-659	ESD torx screwdriver T4
6-661	ESD torx screwdriver T5
6-662	ESD torx screwdriver T6
6-663 L	ESD torx screwdriver T7
6-664 L	ESD torx screwdriver T8
6-750-3	double open-ended wrench 3 x 3.5 mm
6-750-4	double open-ended wrench 4 x 4.5 mm
6-750-5	double open-ended wrench 5 x 5.5 mm
6-750-6	double open-ended wrench 6 x 6.5 mm
6-750-7	double open-ended wrench 7 x 8 mm
6-750-9	double open-ended wrench 9 x 10 mm
6-771	adjustable wrench 0 - 13 mm
6-820	wrench key set 8 pcs (1.5 - 2.0 - 2.5 - 3.0 - 4.0 - 5.0 - 5.5 - 6.0)

Art.-No.	Content
6-984 L	screwdriver EUROLiNE-Power TORX T9 with hole
6-985 L	screwdriver EUROLiNE-Power TORX T10 with hole
6-986 L	screwdriver EUROLiNE-Power TORX T15 with hole
7-425	dust brush bristles width 25 mm
7-506	tape measure 2 m
7-508	steel tape measure 30 cm
7-511	digital caliper DIN862 precision 150 mm
7-616	PUK saw in case



Inner dimension: 470 x 360 x 210 mm



with tools, portable: 10400 g
with tools, rollable: 11900 g



113 tools



6500 R BOSS with tools, rollable
6515 R BOSS without tools, rollable
6500 BOSS with tools, portable
6515 BOSS without tools, portable

TOOL SET TELECOM

► 6600 tool case TELECOM 124 pcs

► 6600 R tool case TELECOM with wheels 12 pcs

The case with special tools and test equipment for the installation and maintenance of complex telecommunications systems as well as for working with VDE-insulated tools.

The rigid and robust roller case for heavy loads. With a double aluminium frame and the break-resistant X-ABS case shells, the case can carry loads of up to 40 kg and is also airworthy. The 4-fold telescopic pull-out is powder-coated and has an

ergonomic handle that complements the case handle in a form-fit manner. The wide wheelbase and the rubberised and mounted rollers allow the PROTECTION XL to also master uneven paths. The ratchet hinges with case lid lock come as standard with our tool cases.

Art.-No.	Content
6615	tool case PROTECTION XL 42 empty pockets
13-906 VDE	VDE side cutters 160 mm
13-915 VDE	VDE telephone pliers 160 mm serrated jaws straight with wire cutter
13-927 VDE	VDE flat nose pliers 160 mm with serration
13-936 VDE	VDE combination pliers 160 mm with serration
14-651 VDE	VDE screwdriver slot blade 2.5 x 75 mm
14-652 VDE	VDE screwdriver slot blade 3.5 x 100 mm
14-653 VDE	VDE screwdriver slot blade 4.0 x 100 mm
14-654 VDE	VDE screwdriver slot blade 5.5 x 125 mm
14-681 VDE	VDE screwdriver cross-recess PH0 Ø 3.0 mm
14-682 VDE	VDE screwdriver cross-recess PH1 Ø 4.5 mm
14-683 VDE	VDE screwdriver cross-recess PH2 Ø 6.0 mm
16-299 VDE	VDE socket wrench 4.0 mm
16-301 VDE	VDE socket wrench 5.0 mm
16-302 VDE	VDE socket wrench 5.5 mm
2-265-1	test prod red blade 1 mm
2-265-2	test prod black blade 1 mm
2-275	magnifying mirror Ø 21 mm 180 mm
2-601	IC-tweezers 125 mm
2-656	PLCC-extractor
2-620	LED flashlight 143 x 19 mm
2-701	LSA-Plus insertion tool
3-0605	combination crimping pliers
3-573	water pump pliers 180mm with push-button

Art.-No.	Content
3-601-15	ESD side cutters CLASSICline semi flush 115 mm
4-360-E03	watchmakers screwdriver set 6pcs (slot 0.6 - 1.0 - 1.5 - 2.0 - 2.5 - 3.0)
5-107	anatomical tweezers 150 mm form 22b
5-117	anatomical tweezers 145 mm form 40 serrated
5-240	warding files set 6 pcs (flat, round, blunt, pointed, 3-edge, 4-edge)
5-505	stripping knife Ø 4 - 28 mm with hook blade
5-535	coax cable stripper Ø 4.8 - 7.5 mm
6-320	socket wrench set 36 pcs with ratchet+extension
6-500	double open-ended wrench set 8 pcs (6 x 7 - 8 x 9 - 10 x 11 - 12 x 13 - 14 x 15 - 16 x 17 - 18 x 19 - 20 - 22)
6-600	combination wrench set 12 pcs (6 - 7 - 8 - 9 - 10 - 11 - 12 - 13 - 14 - 17 - 19 - 22)
6-950	ballpoint wrench key set 9 pcs (1.5 - 2.0 - 2.5 - 3.0 - 4.0 - 5.0 - 6.0 - 8.0 - 10.0)
6-995	TORX wrench key set with hole 8 pcs (T9 - T10 - T15 - T20 - T25 - T27 - T30 - T40)
7-114	engineer hammer to DIN 1041, 200 g
7-425	dust brush bristles width 25 mm
7-429	insulating tape 25 mm wide, 25 m (12 mm core)
7-506	tape measure 2 m
7-616	PUK saw in case
8-376	gas soldering iron Independent 75
8-390	desoldering suction pump PRAKTIK 20 mm diameter RD-7376
9-316	ESD chip-container 57 x 36 x 17 mm

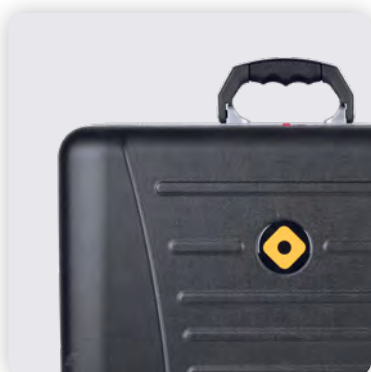



Inner dimension: 470 x 360 x 210 mm



with tools, portabel: 11900 g
with tools, rollable: 13500 g



124 tools



- 6600 R** tool case TELECOM with tools, rollable
- 6615 R** tool case TELECOM without tools, rollable
- 6600** tool case TELECOM with tools,
- 6615** tool case TELECOM without tools



TOOL SETS COMPACT MOBIL

► 7000 tool case COMPACT-MOBIL with wheels 61 pcs

► 7000 OR tool case COMPACT-MOBIL without wheels 61 pcs

The case with special tools for assembling and servicing electronic equipment. If you need more tools, this case is ideal for transporting them. Up to 61 tools can be clearly stored here. Thanks to the high-quality rollers and the wide wheelbase, this case also lies well in the curve and annoying dragging is a thing of the past. The rigid and robust roller case for heavy loads. With a double aluminium frame and the break-resistant X-ABS case shells, the case can carry loads of up to 40 kg and is also airworthy.

The 4-fold telescopic pull-out is powder-coated and has an ergonomic handle that complements the case handle in a form-fit manner. The wide wheelbase and the rubberised and mounted rollers allow the PROTECTION XL to also master uneven paths. The ratchet hinges with a case lid lock come as standard with our tool cases.

Art.-No.	Content
7015	tool case PROTECION XL with wheels 58 empty pockets
1-735	adjusting screwdriver-handle double-ended 100 mm plastic
1-738	hard plastic blade (Bit) slot blade 1.5 x 0.5 x 32 mm
1-739	hard plastic blade (Bit) slot blade 3 x 0.5 x 32 mm
1-909	engineer mirror with extension Ø 23 mm
2-126	ESD desoldering lever slotted at one ends
2-127	ESD tin knife pointed sharp blade
2-132	spring puller 175 mm
2-155	claw-type gripper with 3 hardened wire claws
2-161	scriber, magnetic lifter with telescopic slide-out
2-166	glass fibre contact cleaner brush Ø 4mm
2-265-1	test prod red blade 1 mm
2-265-2	test prod black blade 1 mm
2-296	hand magnifier 3x magnification LED light
2-601	IC-tweezers 125 mm
2-620	PLCC-extractor
2-656	LED flashlight 143 x 19 mm
3-133-16	side cutters 145 mm
3-235-16	telephone pliers 160 mm with serration jaws length 55 mm
3-601-15	ESD side cutters CLASSICline semi flush 115 mm
3-606-15	ESD side cutters CLASSICline flush 120 mm
3-632-15	ESD flat nose pliers CLASSICline not serrated jaws 120 mm
3-633-15	ESD snipe nose pliers CLASSICline not serrated jaws 120 mm
3-732-16	combinations pliers 165 mm with serration
4-344 VDE	VDE voltage tester slot blade 3.5 x 0.7 x 110 mm
4-351	offset screwdriver slot blade 4.5 x 0.65 x 100 mm
4-504	screwdriver EUROline-Power slot blade 5.5 x 1.0 x 100 mm
4-506	screwdriver EUROline-Power slot blade 6.5 x 1.2 x 125 mm
4-508	screwdriver EUROline-Power slot blade 8.0 x 1.2 x 150 mm
4-522	screwdriver EUROline-Power slot blade 3.0 x 0.5 x 75 mm
4-523	screwdriver EUROline-Power slot blade 4.0 x 0.8 x 100 mm
4-533	screwdriver EUROline Power cross-recess PH1

Art.-No.	Content
4-534	screwdriver EUROline Power cross-recess PH2
4-542	screwdriver EUROline Power cross-recess PZ0
4-543	screwdriver EUROline Power cross-recess PZ1
4-603	ESD screwdriver slot blade 1.5 x 0.25 x 40 mm
4-605	ESD screwdriver slot blade 2.0 x 0.40 x 40 mm
4-606	ESD screwdriver slot blade 2.5 x 0.4 x 50 mm
4-607	ESD screwdriver slot blade 3.0 x 0.5 x 50 mm
4-608	ESD screwdriver slot blade 3.5 x 0.6 x 60 mm
4-621	ESD screwdriver cross-recess PH000
4-622	ESD screwdriver cross-recess PH00
4-623	ESD screwdriver cross-recess PH0
4-624	ESD screwdriver cross-recess PH1
5-006	component tweezers 145 mm jaws insulated
5-049	SMD tweezers 110 mm form 4 stainless steel
5-0605	stripping tool with adjustable knives
5-107	anatomical tweezers 150 mm form 22b
5-115	thermal tweezers 165 mm form R30 cross tweezers
5-117	anatomical tweezers 145 mm form 40 serrated
5-161	clamping scissors with teething jaws
5-191	ESD plastic tweezers 120 mm form 2a tips 2mm wide
5-194	ESD plastic tweezers 120 mm form 6
5-301	scissors with teething
6-104	socket wrench EUROline-Power hex 5.0 mm
6-105	socket wrench EUROline-Power hex 5.5 mm
6-107	socket wrench EUROline-Power hex 7.0 mm
6-771	adjustable wrench 0 - 13 mm
6-984 L	screwdriver EUROline-Power TORX T9 with hole
6-985 L	screwdriver EUROline-Power TORX T10 with hole
6-986 L	screwdriver EUROline-Power TORX T15 with hole
7-425	dust brush bristles width 25 mm



7015



Inner dimension: 470 x 360 x 210 mm



with tools, portable: 8100 g
with tools, rollable: 9900 g



61 tools



- 7000** tool case COMPACT MOBIL with tools, rollable
- 7015** tool case COMPACT MOBIL without tools, rollable
- 7000 OR** tool case COMPACT MOBIL with tools
- 7015 OR** tool case COMPACT MOBIL without tools



CASES AND SETS
not dissipative

REGISTER SORTED BY KEYWORDS

A	Page
ACCENT tool set	148
adapter	98 - 103
adjustment tools	94 - 95
ADVANCED tool case	174 - 175
aluminium screwdriver	84 - 85
ANTISTATIC tool set	145
B	Page
Bamboo tweezers	68
BASIC tool case	174 - 175
bit adapter	100 - 102
bit set	103 - 105
BLACKline pliers	43 - 45
board holder	27
BOSS tool case	188 - 189
brush	36
C	Page
cable knives, cable scissors	21, 112 - 113, 122, 137, 141
calliper	115
calliper gauge	115
carbide cutter	49 - 50
cases with wheels	186 - 193
ceramic tools	73, 94 - 95, 108, 113
clamping vice	14 - 27
CLASSICline pliers	46 - 47, 80 - 81, 144 - 145, 147 - 148, 151
claw-type gripper	109
cleaning tools	36, 108
combination pliers	52, 134 - 136
COMPACT MOBIL	
COMPLETE tool case	174 - 175
contact bracelet	32
contact cleaner	108
crimping pliers / press pliers	125, 156
crocodile clip	32
cross tweezers	71
Cutter	112
cutting tweezers	71
D	Page
desoldering	35
desoldering lever	108
E	Page
earthing cable	32 - 33
earthing plug	32
electrician screwdriver	77 - 81, 84 - 86, 94 - 95, 104 - 105
electrician screwdriver POWERline	82 - 83

ELITE tool set	146 - 147
end cutting pliers	43 - 46, 48 - 49, 49 - 52
end cutting pliers / lace cutter	43 - 46, 48 - 49, 49 - 52
EPA tool case	162 - 163
ESD cases / ESD sets	144 - 155, 162 - 163
ESD information	4 - 7, 30 - 31
ESD screwdriver / sets	75 - 78, 79 - 81, 145, 148 - 162
EUROline pliers	48 - 49
extensions	101 - 103, 105
F	Page
feeler gauge	113
files	118
flashlight	108
Flat nose pliers / needle nose pliers	43, 46, 48 - 52
foot parts	20, 26
G	Page
grounding mat,	34 - 35, 145, 150 - 155
grounding point	
H	Page
hammer	119
handling-Set	33 - 34, 145, 151 - 155
Handy repair set	105, 152 - 153
HANDY tool case	158 - 159
head parts	24, 25, 27
I	Page
insertion tools	124
inspection tools	108 - 109
inspection tools	108, 114 - 115
interchangeable blades ESD	76, 146 - 147
jaws	19, 20 - 21, 125
K	Page
knives	113, 122, 141
L	Page
lace cutter	
lifting tool	109
M	Page
Magnetic foot, Magnetic holder,	25, 98 - 102, 104, 109
Magnetic mat	
magnifying glasses	108
magnifying lamp	38 - 39
mats	34 - 35, 109
Measuring tape, steel measuring tape	114
measuring tool	1142 - 115
microscope	37
microscope tweezer	63

mirror	108
Mounting / soldering tweezers	58, 65 - 67, 71 - 73
N	Page
Netzwerk tool set	156 - 157
NEWS	8 - 9
O	Page
opening tools	109
P	Page
PC CONTACT tool case	1646- 167, 178 - 179
pcket torch	108
PERFORMANCE	
personal grounding	32 - 33
pin wrench	87
plastic tweezer	72
pliers, plier sets	41 - 53, 80 - 81, 134 - 136, 145 - 151
PROTECTION tool case	176 - 177
PROTECTION XL tool case	186 - 187
protective jaws	19, 20 - 21, 125
PTFE coated	68 - 69
quick-reversing device	24 - 25, 27
R	Page
rucksack	133 - 133
S	Page
safetey tools	127 - 141
saw	119, 141
scalpel	113
scissors	112 - 113, 137
screw drivers / screwdriving tools	75 - 89, 92 - 95, 103 - 106, 138 - 141
scriber	114
SECURITY tools case	172 - 173, 184 - 185
shoulder bag	160 - 161
site cutter	44 - 54
SMD tweezer	58 - 65
snipe nose pliers / flat nose pliers	44 - 46, 48 - 49, 49 - 51
socket wrench /	
socket wrench set	78, 81 - 82, 88, 105, 138 - 139
soldering devices / soldering irons	35
soldering tweezers / placement	58, 65 - 67, 71 - 73
SPANNFIX 4.0	16 - 19
SPANNFIX accessories	21, 24 - 27
SPANNFIX Maxi	20
SPANNFIX VARIO	24 - 25
SPANNFIX, SPANNFIX ESD	22 - 23

spring hooks / spring extractors	108
stripping tools	112, 122 - 125
T	Page
table mat	34 - 35, 145, 150 - 155
TECHNIC tool case	168 - 169, 180 - 181
TECHNICline pliers	50 - 51
Teflon tweezers	68 - 69
TELECOM tool case	190 - 191
TELEDATA tool case	170 - 171, 182 - 183
test prod	108
thread cutting set	109
tin knives	108
Titanium tweezers	63
tool case	143 - 193
tool holder VARIO	36, 45, 47 - 48, 50, 72, 79 - 81
torque tools	97 - 102
TRENDY tool set	150 - 151
trimmer	91 - 95
turning pliers	53
tweezer with interchangeable tips	73
tweezers, tweezer sets	55 - 73
U	Page
ULTRA FINE tweezers	64 - 65
V	Page
VARIO holder	36, 45, 47 - 48, 50, 72, 78 - 81
VDE cases / rucksack	128 - 132
VDE screwdriver / screwdriving tools	138 - 139
VDE tools / VDE accessories	140 - 4139
vice	15 - 27
voltage tester	141
W	Page
Wafer tweezers	70
watchmaker screwdriver	84 - 86
water level	113
water pump pliers	53
wire holder	51
work place ESD	6 - 7, 23, 25 - 27, 30 - 36, 38, 79 - 81, 144 - 155
wrench	89, 138 - 140

REGISTER SORTED BY ARTICLE NUMBER

Art.-No.	Page	Art.-No.	Page	Art.-No.	Page	Art.-No.	Page	Art.-No.	Page
1-150	92	1-978	108	3-245-16	52	3-689-15	49	4-321	83
1-151	92	2-101	108	3-255-16	52	3-732-13	52	4-343 VDE	138
1-152	92	2-102	113	3-531-16	52	3-732-16	52	4-343 VDE	141
1-153	92	2-111-VE3	109	3-573	53	3-734-13	53	4-344 VDE	141
1-154	92	2-113	109	3-575-6	53	3-815-16	124	4-351	83
1-155	92	2-119	109	3-0601	125	3-0856	124	4-360-E01	85
1-156	92	2-123	109	3-601-15	46	3-871-6	125	4-360-E02	85
1-157	92	2-124	109	3-602-15	46	3-875-6	125	4-360-E03	85
1-300	93	2-126	108	3-0603	125	3-901-7	44	4-360-E04	85
1-301	93	2-127	108	3-603-15	46	3-902-7	44	4-360-E05	84
1-302	93	2-128	108	3-604-15	46	3-905-7	44	4-363-AL	85
1-303	93	2-129	109	3-0605	125	3-906-7	44	4-364-AL	85
1-304	93	2-130	109	3-606-15	46	3-932-7	44	4-365-AL	85
1-305	93	2-130	109	3-0609	125	3-933-7	44	4-366-AL	85
1-306	93	2-131	109	3-0611	125	3-945-7	44	4-367-AL	85
1-307	93	2-132	109	3-0612	125	3-960	45	4-368-AL	85
1-725	95	2-133	109	3-625-15	46	3-960 C	47	4-371-AL	85
1-735	95	2-145	93	3-627-15	46	3-960 E	48	4-372-AL	85
1-738	95	2-155	109	3-631-15	46	3-960 ES	48	4-373-AL	85
1-739	95	2-155-13	109	3-632-15	46	3-960 T	51	4-374-AL	85
1-750	95	2-157	109	3-633-15	46	3-960 TS	51	4-375-AL	85
1-751	95	2-161	109	3-634-15	46	3-960 VB	45	4-376-AL	85
1-752	95	2-162	108	3-0641	53	3-960 VC	47	4-380	86
1-753	95	2-163	108	3-0645	53	3-960 VE	48	4-381	86
1-754	95	2-164-VE24	108	3-650 V	47	3-960 VT	51	4-382	86
1-755	95	2-166	108	3-651-15	49	3-961-15	50	4-383	86
1-756	95	2-167-VE10	108	3-651-15 DR	49	3-962-15	50	4-384	86
1-757	95	2-168	108	3-652-15	49	3-963-15	50	4-385	86
1-758	95	2-169-VE12	108	3-653-15	49	3-964-15	50	4-392	86
1-761	95	2-265-1	108	3-654-15	49	3-966-15	50	4-393	86
1-762	95	2-265-2	108	3-655-15	49	3-967-15	50	4-504	82
1-763	95	2-275	108	3-656-15	49	3-969-15	50	4-506	82
1-764	95	2-282	108	3-657-15	49	3-970 T	51	4-508	82
1-765	95	2-292	108	3-658-15	49	3-971-15	50	4-521	82
1-766	95	2-293	108	3-661-15	49	3-972-15	50	4-522	82
1-767	95	2-296	108	3-663-15	49	3-973-15	50	4-523	82
1-851	94	2-601	66	3-665-15	49	3-981-15	50	4-524	82
1-852	94	2-601-7	66	3-668-15	49	3-985-15	50	4-530	83
1-853	94	2-601-13	66	3-669-15	49	3-986-15	50	4-532	82
1-854	94	2-605	109	3-672-15	49	3-991-15	50	4-533	82
1-855	94	2-620	109	3-673-15	49	3-992-15	50	4-534	82
1-856	94	2-656	108	3-674-15	49	3-993-15	50	4-542	82
1-857	94	2-701	124	3-675-15	49	3-996-15	50	4-543	82
1-858	94	2-702	124	3-681-15	49	3-999-1	51	4-544	82
1-861	94	2-800	109	3-682-15	49	3-999-2	51	4-563	100
1-862	94	3-132-16	52	3-683-15	49	4-106	101	4-564	101
1-865	94	3-133-13	52	3-685-15	49	4-107	101	4-565	101
1-866	94	3-133-16	52	3-686-15	49	4-261	83	4-566	101
1-867	94	3-235-16	52	3-687-15	49	4-301	83	4-567	101
1-909	108	3-245-13	52	3-688-15	49	4-311	83	4-603	77

Art.-No.	Page	Art.-No.	Page	Art.-No.	Page	Art.-No.	Page	Art.-No.	Page
4-605	77	4-981	100	5-051-13	58	5-067	66	5-090 V	72
4-606	77	4-982	100	5-051-Ti	65	5-067-13	66	5-106-7	68
4-607	77	4-983	100	5-051-UF	64	5-068	66	5-106-7-13	68
4-608	77	4-984	100	5-051-UF-13	64	5-068-13	66	5-107	68
4-609	77	4-985	100	5-052	58	5-069	58	5-107-1	68
4-610	78	4-986	100	5-052-13	58	5-069-13	58	5-107-6	68
4-610 VC	80	4-3706-AL	85	5-052-TP	63	5-070-UF	65	5-107-7	68
4-620	78	5-006	66	5-052-UF	64	5-070-UF-13	65	5-107-7-13	68
4-620 VC	80	5-006-7	66	5-052-UF-13	64	5-071	60	5-107-9	68
4-621	77	5-006-7-13	66	5-053	58	5-071-13	60	5-107 VDE	68
4-622	77	5-007	66	5-053-13	58	5-072	60	5-110	68
4-623	77	5-007-13	66	5-053-TP	63	5-072-13	60	5-114-7	66
4-632	77	5-008	66	5-054	58	5-072-UF	64	5-114-7-13	66
4-633	77	5-009	66	5-054-13	58	5-072-UF-13	64	5-115	71
4-652	77	5-010-ATP	63	5-055	58	5-073	60	5-117	68
4-653	77	5-010-BTP	63	5-055-13	58	5-073-13	60	5-117-1	68
4-775	88	5-013-7	66	5-055-Ti	65	5-074	60	5-117-6	68
4-820	83	5-013-7-13	66	5-055-UF	64	5-074-13	60	5-117-7	68
4-901	76	5-014-7	66	5-055-UF-13	64	5-075	60	5-117-7-13	68
4-905	76	5-014-7-13	66	5-056	58	5-075-13	60	5-117-9	68
4-906	76	5-015-7	66	5-056-13	58	5-076	60	5-117 VDE	68
4-907	76	5-015-7-13	66	5-057	71	5-076-13	60	5-119	68
4-909	104	5-016-7	66	5-057-13	71	5-077	60	5-121	68
4-910	105	5-016-7-13	66	5-058	71	5-077-13	60	5-121-1	68
4-911	76	5-020	68	5-058-13	71	5-077-TP	63	5-121-6	68
4-912	76	5-030	65	5-059	62	5-078	60	5-121-7	68
4-919	76	05-0030	72	5-059-13	62	5-078-13	60	5-121-7-13	68
4-920	76	5-030-A	65	5-059-Ti	65	5-078-Ti	65	5-121-9	68
4-921	76	5-031	65	5-060	58	5-078-UF	64	5-125	68
4-922 L	76	5-035	65	5-060-A	60	5-078-UF-13	64	5-130	67
4-923 L	76	5-036	65	5-060-AES	60	5-079	71	5-130-A	67
4-930	103	5-037	65	5-060-AN	60	5-079-13	71	5-155	71
4-932	76	5-048	58	5-060-AST	60	5-082-TP	63	5-155-1	71
4-933	76	5-048-13	58	5-060-AV	60	5-083	60	5-156	71
4-934	76	5-048-TP	63	5-060-ES	58	5-083-13	60	5-156-7	71
4-950	104	5-049	58	5-060-N	58	5-085	60	5-161	112
4-970	103	5-049-13	58	5-060-ST	58	5-085-13	60	5-180	72
4-970-A	103	5-049-UF	64	5-060-V	58	5-086	60	5-181	124
4-970-B	103	5-049-UF-13	64	5-061	62	5-086-13	60	5-190 V	72
4-970-C	103	5-050	58	5-061-13	62	5-087	60	5-191	72
4-970-G	102	5-050-A	60	5-062	66	5-087-13	60	5-192	72
4-970-KSB	102	5-050-AES	60	5-062-13	66	5-088	58	5-193	72
4-971	100	5-050-AN	60	5-063	66	5-088-13	58	5-194	72
4-972	100	5-050-AST	60	5-063-13	66	5-088-TP	63	5-195	72
4-973	100	5-050-AV	60	5-064	66	5-089	58	5-210	118
4-974	100	5-050-ES	58	5-064-13	66	5-089-13	58	5-240	118
4-975	100	5-050-N	58	5-065	66	5-090-0	36	5-261	118
4-976	100	5-050-ST	58	5-065-13	66	5-090-0	79	5-301	112
4-980-G	102	5-050-V	58	5-066	66	5-090-1	79	5-301-13	112
4-980-KSB	102	5-051	58	5-066-13	66	5-090-2	79	5-302	112

REGISTER SORTED BY ARTICLE NUMBER

Art.-No.	Page	Art.-No.	Page	Art.-No.	Page	Art.-No.	Page	Art.-No.	Page
5-305	112	5-519	113	6-340-3	105	6-950	87	9-227	20
5-306	112	5-531	124	6-500	89	6-979	82	9-228	20
5-308	112	5-531-10	124	6-600	89	6-981	82	9-229	20
5-308-13	112	5-532	123	6-610	78	6-983 L	82	9-240	25
5-310	113	5-533	123	6-610 VC	81	6-984 L	82	9-250	24
5-310-13	113	5-534	123	6-657	77	6-985 L	82	9-251	
5-311	112	5-535	123	6-658	77	6-986 L	82	9-251 ESD	26
5-352	113	5-536	123	6-659	77	6-987 L	82	9-251 SW	26
5-353	113	5-542	122	6-660	78	6-995	87	9-252	
5-411	70	5-0605	123	6-660 VC	81	7-114	119	9-252 ESD	27
5-411-13	70	5-852	58	6-661	77	7-116	119	9-253 ESD	27
5-412	70	5-857	71	6-662	77	7-121	119	9-254	27
5-412-13	70	5-857-13	71	6-663 L	77	7-122	119	9-255 ESD	27
5-413	70	5-858	71	6-664 L	77	7-123	119	9-256	27
5-413-13	70	5-858-13	71	6-665 L	77	7-405	119	9-257 ESD	27
5-414	70	5-859	62	6-666 L	77	7-410	119	9-261	26
5-414-13	70	5-859-13	62	6-750	89	7-421	36	9-261 SW	26
5-415	70	5-861	62	6-771	89	7-422	36	9-262	26
5-415-13	70	5-861-13	62	6-772	89	7-435	119	9-262 SW	26
5-421	70	5-862	62	6-811	87	7-502	114	9-270	25
5-421-13	70	5-862-13	62	6-812	87	7-503	114	9-281	26
5-422	70	5-863	62	6-813	87	7-506	114	9-281 SW	26
5-422-13	70	5-863-13	62	6-814	87	7-508	114	9-284 SW	26
5-423	70	5-864	62	6-815	87	7-509	115	9-290	16
5-423-13	70	5-864-13	62	6-816	87	7-511	115	9-291	17
5-424	70	5-865	62	6-817	87	7-512	115	9-316-VE5	36
5-424-13	70	5-865-13	62	6-818	87	7-513	115	9-321-VE10	36
5-431	73	5-866	62	6-819	87	7-514	115	9-322-VE10	36
5-431-0	73	5-866-13	62	6-820	87	7-515	114	9-334	36
5-432	73	5-867	62	6-821	87	7-516	115	9-341	33
5-432-0	73	5-867-13	62	6-822	87	7-521	114	9-341-1	33
5-433	73	5-874	60	6-823	87	7-535	114	9-342-1	33
5-433-0	73	5-878	60	6-825	87	7-616	119	9-341-2	33
5-434	73	5-879	71	6-826	87	7-617	119	9-342-2	33
5-434-0	73	5-879-13	71	6-827	87	8-238	35	9-342	33
5-441	73	6-104	82	6-828	87	8-376	35	9-342	33
5-441-0	73	6-105	82	6-851	87	8-390	35	9-341	33
5-443	73	6-107	82	6-852	87	9-101	38	9-343	33
5-443-0	73	6-200	88	6-853	87	9-101	39	9-343-1	32
5-452	73	6-201	88	6-854	87	9-121	38	9-344-1	32
5-452-0	73	6-202	88	6-855	87	9-121	39	9-353	32
5-454	73	6-203	88	6-856	87	9-155	37	9-354	34
5-454-0	73	6-204	88	6-857	87	9-158	37	9-354-100	34
5-501	122	6-205	88	6-858	87	9-158-1	37	9-354-A	34
5-503	122	6-206	88	6-859	87	9-161	38	9-354	150
5-504	122	6-207	88	6-861	87	9-161	39	9-359	32
5-505	122	6-320	88	6-862	87	9-205	22	9-359-1	32
5-506	122	6-340	105	6-863	87	9-205 ESD	23	9-359-2	32
5-515	113	6-340-1	101	6-864	87	9-215	23	9-360	34
5-517	113	6-340-2	101	6-865	87	9-226	20	9-360-0	34

Art.-No.	Page	Art.-No.	Page	Art.-No.	Page	Art.-No.	Page	Art.-No.	Page
9-360-A	34	14-658 VDE	138	16-484 VDE	139	17-531 VDE	141	8160 VDE	130
9-361	34	14-681 VDE	138	16-485 VDE	139	17-541 VDE	141	8200 VDE	132
9-361-0	34	14-681 VDE	138	16-486 VDE	139	17-547 VDE	141	8300 VDE	132
9-361-A	34	14-682 VDE	138	16-487 VDE	139	17-551 VDE	140	9323-VE10	36
9-367	34	14-682 VDE	138	16-488 VDE	139	17-552 VDE	140		
9-367-0	34	14-683 VDE	138	16-489 VDE	139	17-553 VDE	140		
9-721	38	14-684 VDE	138	16-491 VDE	139	17-702 VDE	140		
9-721	39	14-685 VDE	138	16-492 VDE	139	17-703 VDE	140		
9-900-S6100	21	14-686 VDE	138	16-493 VDE	139	17-706 VDE	140		
9-900-S6125	21	14-692 VDE	138	16-494 VDE	139	17-707 VDE	140		
9-900-S6150	21	14-693 VDE	138	16-495 VDE	139	1500	160		
9-900-S7100	21	14-694 VDE	138	16-496 VDE	139	2210	144		
9-900-S7125	21	14-695 VDE	138	16-497 VDE	139	2212	144		
9-900-S7150	21	14-696 VDE	138	16-498 VDE	139	2220	145		
9-900-S8100	21	15-501 VDE	137	16-501 VDE	139	2230	146		
9-900-S8125	21	15-502 VDE	137	16-502 VDE	139	2240	147		
9-900-S8150	21	15-503 VDE	137	16-503 VDE	139	2250	148		
9-900-S9100	21	15-504 VDE	137	16-504 VDE	139	2252	148		
9-900-S9125	21	15-506 VDE	137	16-505 VDE	139	2270	148		
9-900-S9150	21	15-521 VDE	141	16-506 VDE	139	2280	150		
13-106 VDE	134	15-522 VDE	141	16-507 VDE	139	2282	151		
13-207 VDE	134	15-523 VDE	141	16-508 VDE	139	2286	151		
13-208 VDE	134	15-531 VDE	141	16-509 VDE	139	2290	152		
13-704 VDE	136	15-902 VDE	137	16-511 VDE	139	2291	35		
13-705 VDE	136	15-903 VDE	137	16-512 VDE	139	2300	154		
13-708 VDE	134	15-904 VDE	137	16-513 VDE	139	2301	35		
13-806 VDE	134	16-298 VDE	138	16-514 VDE	139	2302	155		
13-906 VDE	135	16-299 VDE	138	16-515 VDE	139	2700	158		
13-908 VDE	135	16-301 VDE	138	16-517 VDE	139	4100	166		
13-915 VDE	135	16-302 VDE	138	16-531 VDE	139	4400	168		
13-916 VDE	135	16-441 VDE	139	16-533 VDE	139	4700	170		
13-917 VDE	135	16-442 VDE	139	16-535 VDE	139	4750	172		
13-918 VDE	135	16-443 VDE	139	16-536 VDE	139	5000	174		
13-926 VDE	135	16-444 VDE	139	16-537 VDE	139	5000	174		
13-927 VDE	135	16-445 VDE	139	16-538 VDE	139	5000	174		
13-934 VDE	136	16-446 VDE	139	16-539 VDE	139	5750	162		
13-935 VDE	136	16-447 VDE	139	16-541 VDE	139	6100	178		
13-936 VDE	135	16-448 VDE	139	16-542 VDE	139	6400	180		
13-937 VDE	135	16-449 VDE	139	16-543 VDE	139	6500	188		
13-938 VDE	135	16-451 VDE	139	16-544 VDE	139	6500	188		
13-946 VDE	135	16-452 VDE	139	16-545 VDE	139	6600	190		
14-651 VDE	138	16-453 VDE	139	16-547 VDE	139	6600	190		
14-651 VDE	138	16-454 VDE	139	16-548 VDE	139	6700	182		
14-652 VDE	138	16-471 VDE	139	16-551 VDE	139	6750	184		
14-652 VDE	138	16-472 VDE	139	16-773 VDE	140	6900	156		
14-653 VDE	138	16-476 VDE	139	16-774 VDE	140	7000 OR	192		
14-654 VDE	138	16-478 VDE	139	16-775 VDE	140	7000	192		
14-654 VDE	138	16-481 VDE	139	17-501 VDE	140	8100	128		
14-656 VDE	138	16-482 VDE	139	17-521 VDE	140	8110	128		
14-656 VDE	138	16-483 VDE	139	17-523 VDE	140	8150 VDE	130		

Imprint:

Edition 2019/2020

Publisher:

BERNSTEIN
Werkzeugfabrik
Steinrücke GmbHIndustrie Hof Trecknase 1
42897 Remscheid
Germany

November 2019

TERMS OF SALE AND DELIVERY

GENERAL

The nature and scope of delivery are specified in the order confirmation. The following delivery terms shall apply to all deliveries to be carried out by us. Purchasing conditions of the customer do not oblige us, even if we do not expressly contradict this. Verbal or by intercom agreements made require our written confirmation. Obvious mistakes in offers, order confirmations, etc. are expressly reserved and can be considered at any time. We are entitled to process any data relating to the business relationship or in connection with the same concerning buyers, whether the buyer itself or third parties, within the framework of the Federal Data Protection Act.

OFFER

Our offers are permissive, an order is deemed to be granted if confirmed by us in writing. PRICES, DELIVERY BASIS AND PACKAGING Unless otherwise agreed, the prices in Euros, ex works, are exclusive packaging. In the case of special packaging regulations of the customer, the additional costs involved are invoiced. Packaging is not accepted.

DELIVERY

The delivery takes place at the expense and risk of the buyer without regard to who bears the freight costs. We reserve the right to place orders in partial deliveries. For custom-made products, excess or short deliveries of up to 10% are permitted.

DELIVERY TIME

The delivery time begins upon receipt of all information required for the execution of the order. We endeavor to comply with the delivery time specified in the order confirmation. No claims of any kind can be asserted from a delayed delivery.

COMPLAINTS

Complaints can only be accepted within 8 days after receiving of the goods.

The shape and colour of the tool may differ from the item shown in the catalogue.

GUARANTEE

For all BERNSTEIN tools, which are unusable due to proven material or manufacturing defects, we deliver within one year after deliver a replacement. This free replacement service is excluded if the tools have become unusable due to natural wear or improper handling.

DISCLAIMER

We do not assume any guarantee for the suitability of our products for the intended purpose of the customer. For damages caused by unsuitable or improper use, commissioning by the customer or third parties, and for the natural wear and tear we assume no guarantee. Any claims for damages, irrespective of the legal basis, as well as, in particular, the liability by tort (product liability) are excluded to the extent permitted by law.

PAYMENT

Our invoices are payable within 10 days of the invoice date with 2% discount or in 30 days net, unless otherwise agreed in the order confirmation.

RESERVATION OF TITLE

We reserve the title to all goods delivered by us until the buyer has paid all claims arising from the business relationship. The buyer is entitled to resell the reserved goods in ordinary business transactions. In the case of resale, the buyer has to reserve the ownership of the sold goods on the same terms as his customer. The purchaser hereby assigns to us the purchase price claim against the buyer from the resale.

FULFILLMENT AND JURISDICTION

Place of performance and jurisdiction for delivery and payment is Remscheid. In any case, only German law shall apply, with the exclusion of any foreign law.

ONLINE DISPUTE RESOLUTION

The European Commission provides a platform for online dispute resolutions (ODR) which can be accessed at

<https://ec.europa.eu/consumers/odr/> .

In order to settle dispute arising from a contractual relationship with a consumer or from whether such a contractual relationship exists at all, we will participate in dispute settlement proceedings before a consumer dispute resolution body. Consumers can contact their national European Consumer Centre in this regard. The respective contact details of the individual ECCs can be found at

<https://www.evz.de/en/alternative-dispute-resolution/adr-in-europe/>.

CONTENT



WISSENSWERTES

Editorial	01
BERNSTEIN – quality from experiences	02
ESD – The invisible danger	04
Contact - Get in contact with us!	08
New products	10
Content	11
Our assortment	12



CLAMPING TOOLS

SPANNFIX 4.0 – The Next Generation	16
SPANNFIX ball joint vice	20



ESD AND ELECTRONICS

Workplace equipment	29
Pliers	41
Tweezers	55
Screw tools	75



MAINTENANCE AND REPAIR

Adjustment tools and trimmer	91
Torque tools	97
Inspection, Opening and Cleaning tools	107
Cutting and Measuring tools	111
Hand tools	117



VDE AND ELECTRICS

Stripping and crimping tools	121
VDE tools	127



CASES AND SETS

Cases and sets (dissipative)	143
Cases and sets (non dissipative)	159



IMPORTANT

Register sorted by keywords	195
Register sorted by article numbers	197
Terms of sale and delivery	200



BERNSTEIN

**Werkzeugfabrik
Steinrücke GmbH**

Industriehof Trecknase 1
42897 Remscheid

Tel. + 49 (0) 2191 - 9650 - 0
Fax + 49 (0) 2191 - 9650 - 30

verkauf@bernstein-werkzeuge.de
www.bernstein-werkzeuge.de